



US00D366502S

United States Patent [19]

[11] Patent Number: Des. 366,502

Durco, Jr.

[45] Date of Patent: **Jan. 23, 1996

[54] **COMBINED MENU AND SPEAKER HOUSING FOR A DRIVE-IN RESTAURANT**

Assistant Examiner—Marcus Jackson
Attorney, Agent, or Firm—Marc A. Hubbard

[76] Inventor: **Andrew Durco, Jr.**, P.O. Box 850223,
Mesquite, Tex. 75185

[57] **CLAIM**

[**] Term: **14 Years**

The ornamental design for a combined menu and speaker housing for a drive-in-restaurant, as shown and described.

[21] Appl. No.: **10,291**

DESCRIPTION

[22] Filed: **Jul. 30, 1993**

[52] U.S. Cl. **D20/19**

[58] Field of Search D20/10, 19, 20,
D20/39, 40, 41; 40/1, 584, 590, 591, 592,
593, 617, 624

FIG. 1 is a perspective view of a combined menu and speaker housing for a drive-in restaurant showing the new design;

FIG. 2 is an elevational view of the right side of the housing;

FIG. 3 is elevational view of the rear end of the housing;

FIG. 4 is an elevational view of the bottom of the housing;

FIG. 5 is an elevational view of the top of the housing;

FIG. 6 is an elevational view of the left side of the housing; and,

FIG. 7 is an elevational view of the front end of the housing.

[56] **References Cited**

U.S. PATENT DOCUMENTS

D. 161,797	1/1951	Smith	D20/10
D. 207,622	5/1967	Dreyfuss	D20/19
D. 247,830	5/1978	Cunningham	.	
D. 248,894	8/1978	Long	D20/29

OTHER PUBLICATIONS

Brochure of SoundCraft Systems, Co. Oklahoma City, Okla.
Prior to Jun. 1992 (undated).

Primary Examiner—Wallace R. Burke

1 Claim, 3 Drawing Sheets

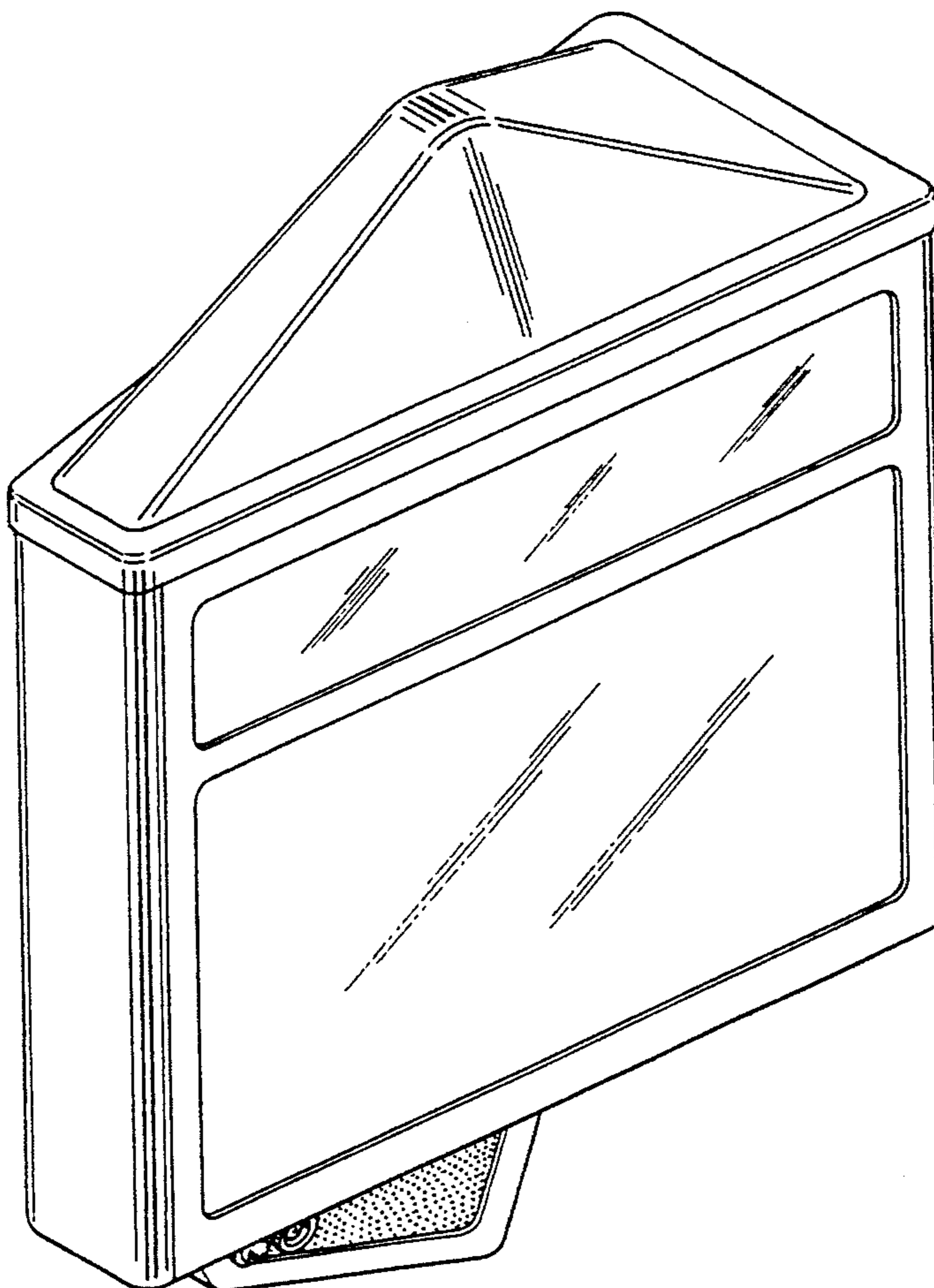

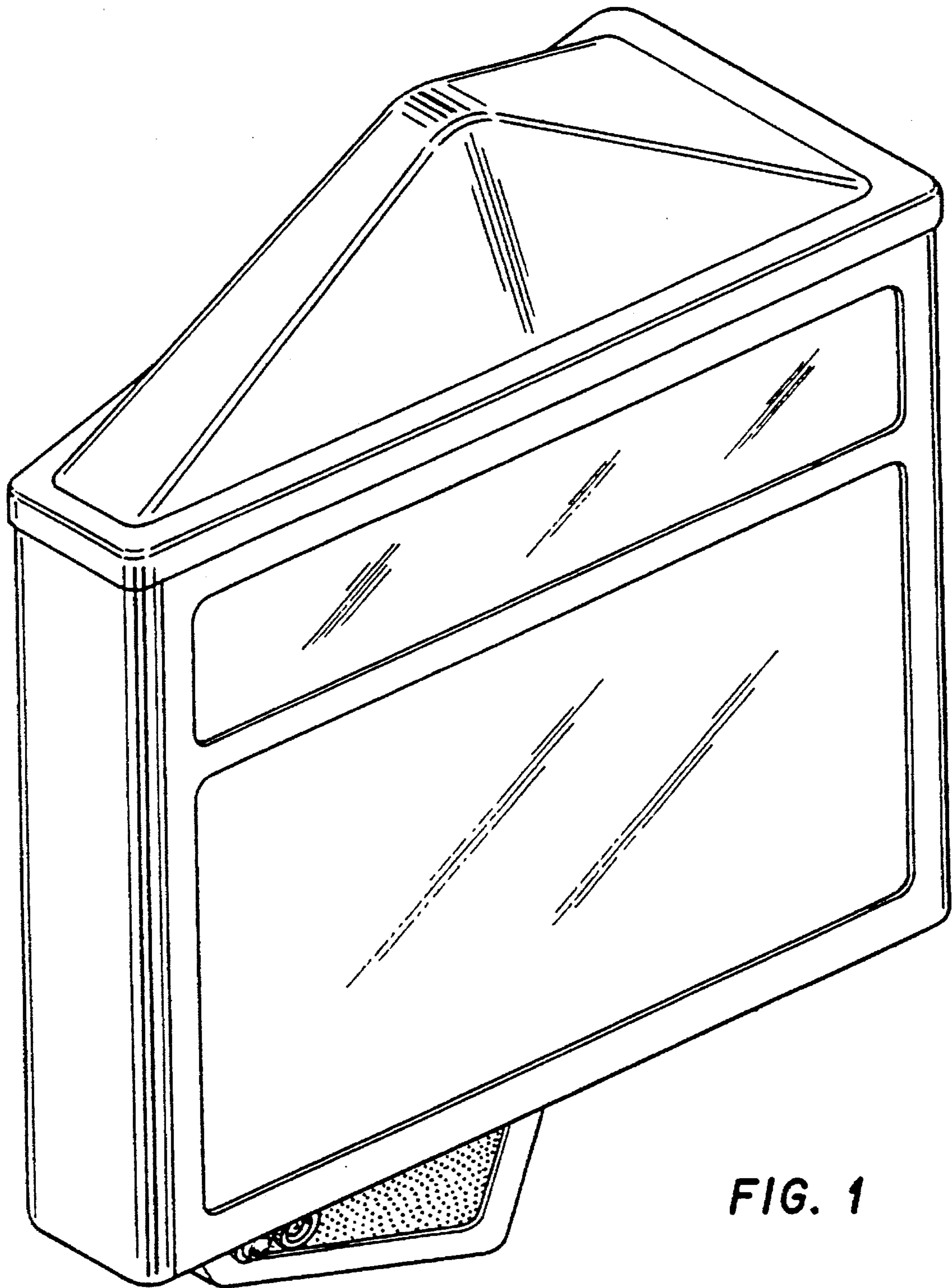

FIG. 1

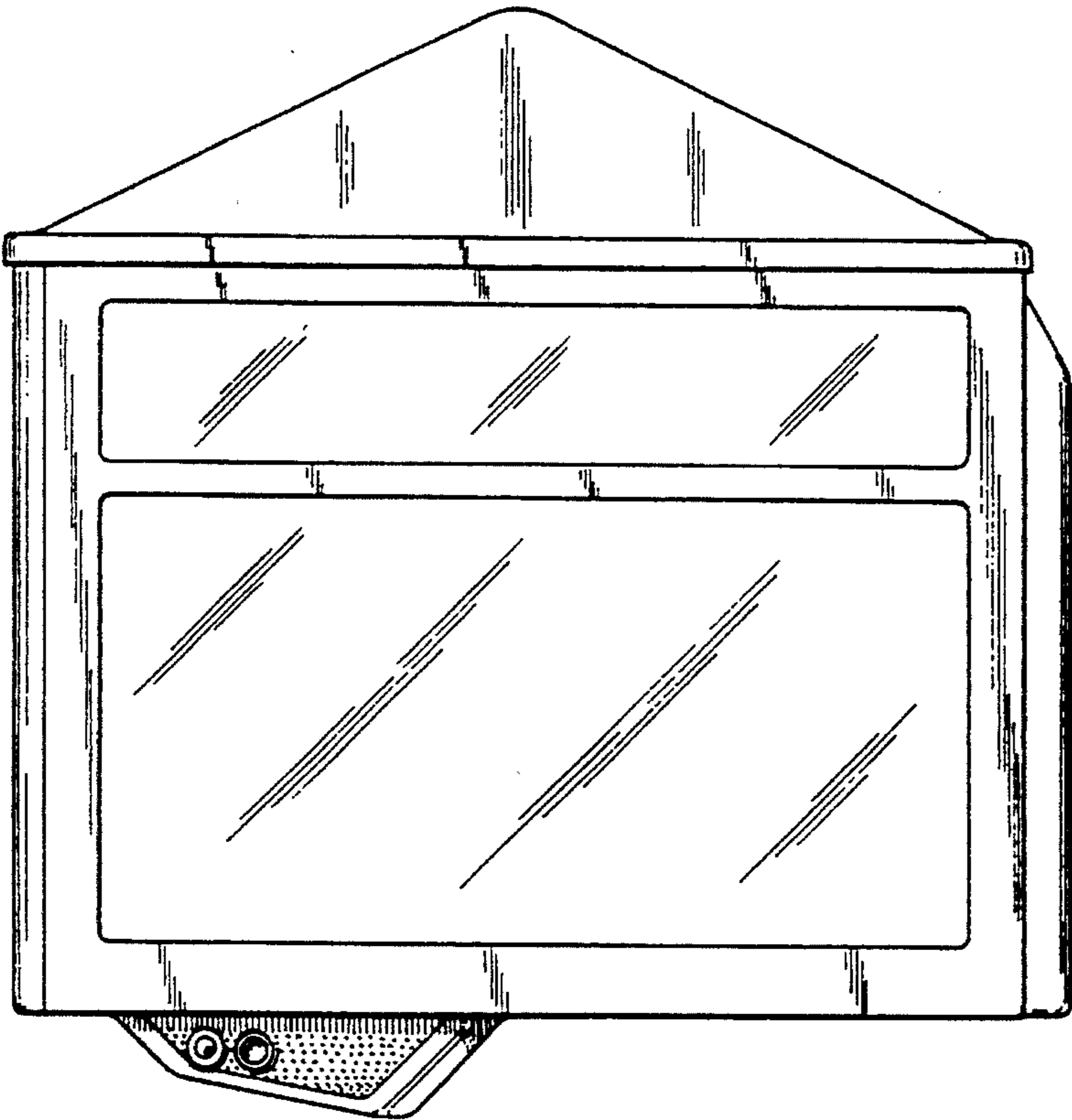

FIG. 2

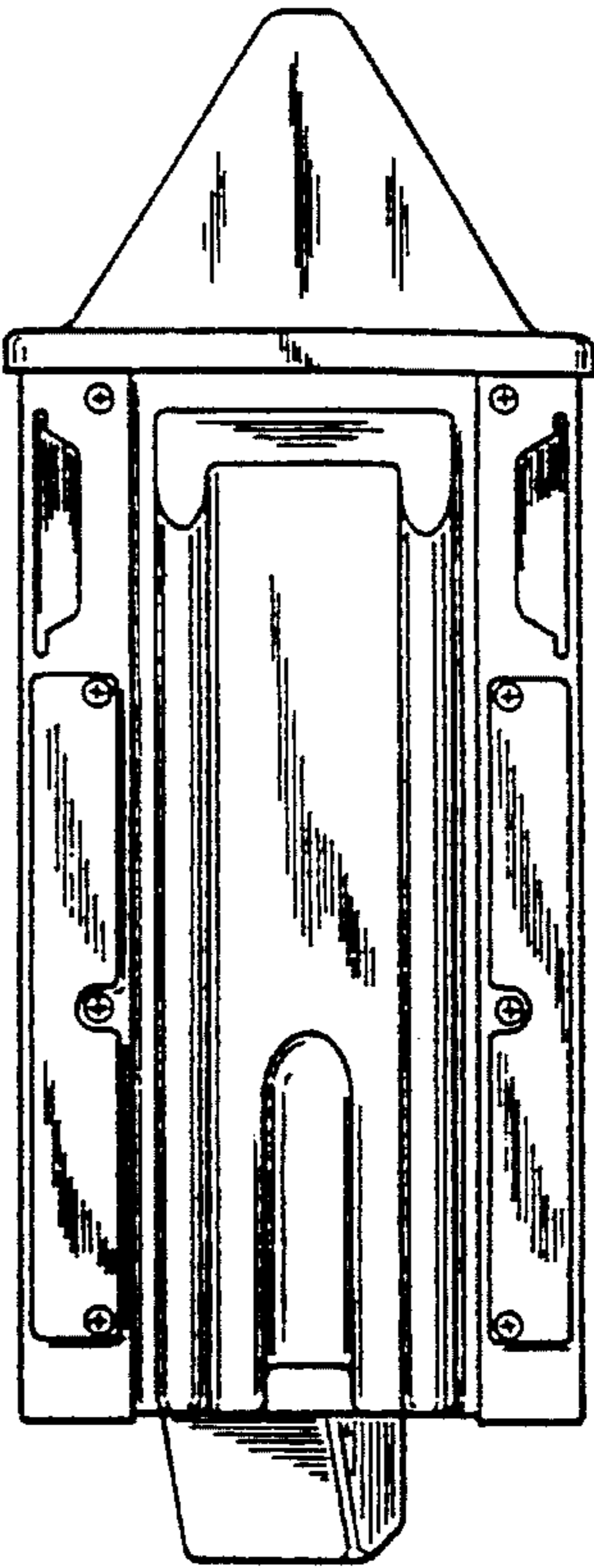

FIG. 3

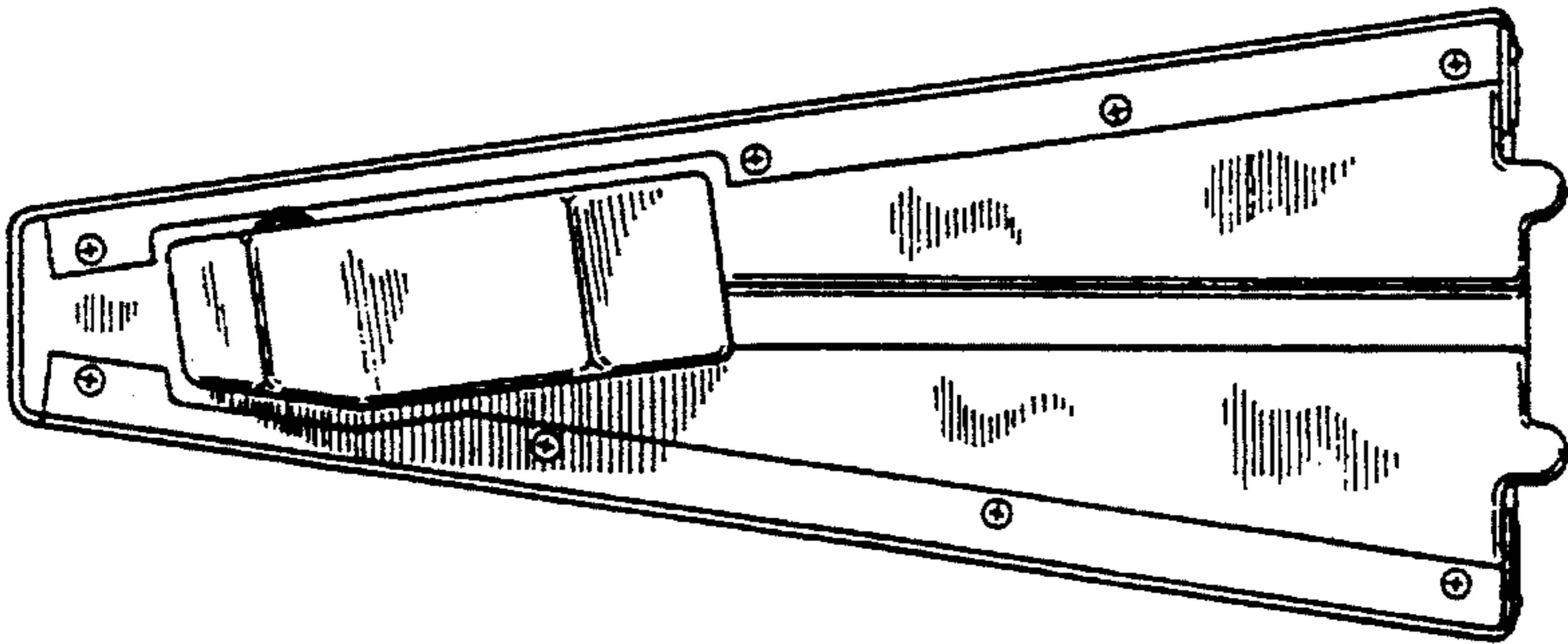

FIG. 4

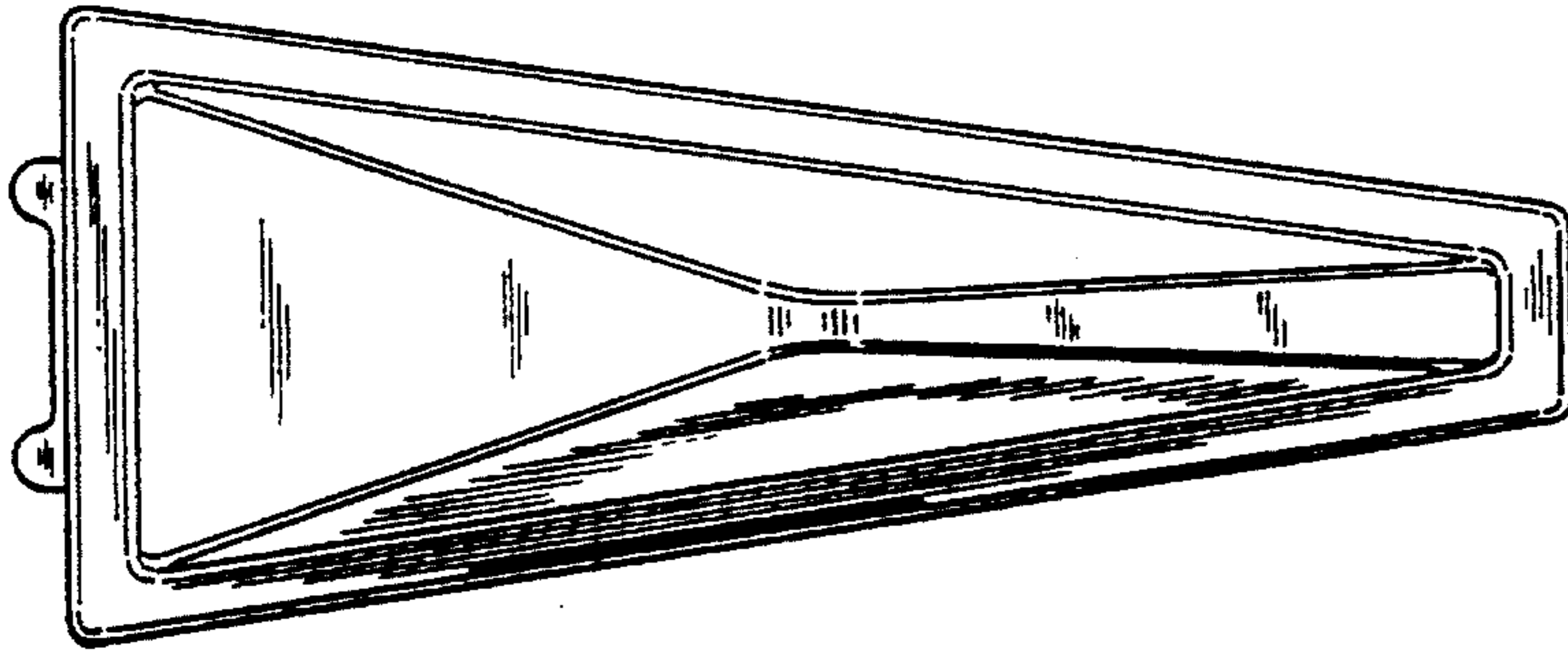

FIG. 5

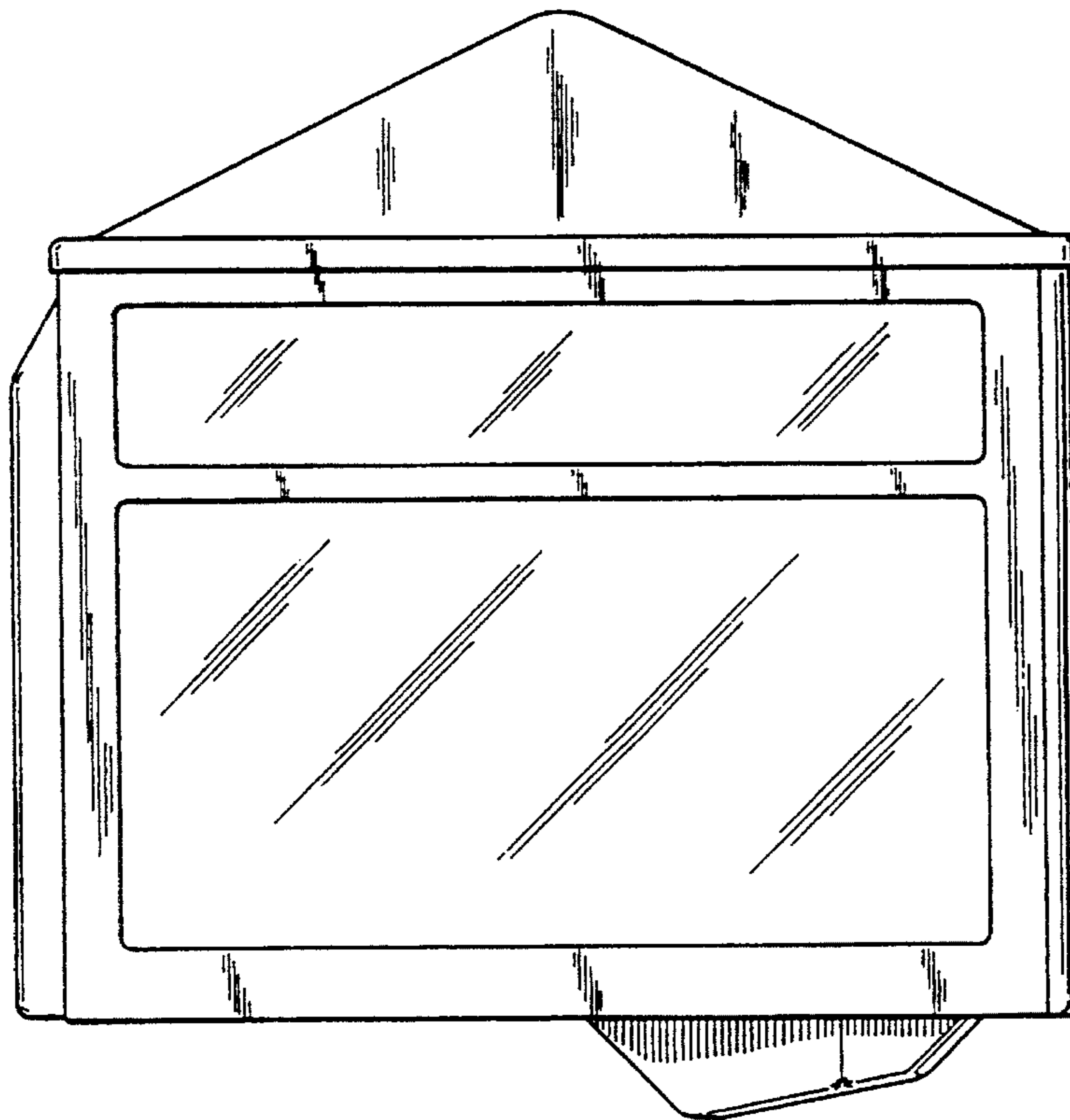

FIG. 6

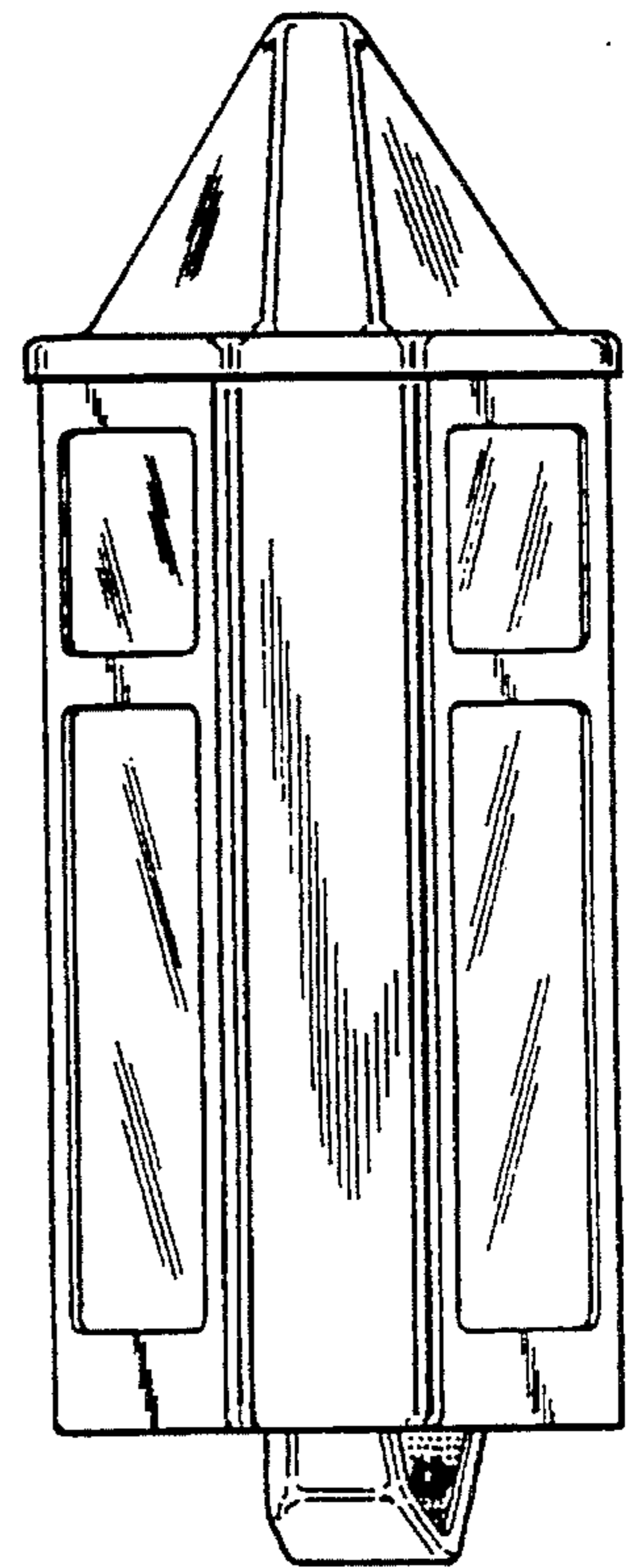

FIG. 7