



US00D366486S

United States Patent [19]

Runquist et al.

[11] Patent Number: **Des. 366,486**

[45] Date of Patent: ****Jan. 23, 1996**

[54] **HEADSET**
[75] Inventors: **Lars Runquist**, St. Paul; **David J. Copeland**, Minneapolis, both of Minn.

[73] Assignee: **Telex Communications, Inc.**, Minneapolis, Minn.

[**] Term: **14 Years**

[21] Appl. No.: **29,556**

[22] Filed: **Oct. 11, 1994**

[52] U.S. Cl. **D14/206**; D14/142

[58] Field of Search D14/142, 205-206, D14/215-216, 223-229, 249, 299; 181/129, 130, 158; 379/430, 431, 444; 381/25, 68.6, 69, 91, 159, 183, 187, 168-169

[56] **References Cited**

U.S. PATENT DOCUMENTS

D. 199,125	9/1964	Flygstad et al.	D14/206
D. 311,521	10/1990	Jonsson et al.	D14/226
D. 340,722	10/1993	Bungardt	D14/242
D. 348,067	6/1994	Lucey et al.	D14/223
2,025,398	12/1935	Pocock et al.	D14/206
2,474,135	6/1949	White	179/182
2,641,327	6/1953	Balmer	181/23
3,999,177	12/1976	Greene	340/279
4,020,297	4/1977	Brodie	179/156 A
4,273,969	6/1981	Foley et al.	179/156 A
4,335,281	6/1982	Scott et al.	179/156 A
4,453,050	6/1984	Enokido	179/182 R

4,617,431	10/1986	Scott et al.	179/156 A
4,864,610	9/1989	Stevens	379/431
4,893,344	1/1990	Tragardh et al.	381/187
4,917,504	4/1990	Scott et al.	381/187
5,210,792	5/1993	Kajihara	379/430
5,260,997	11/1993	Gathey et al.	379/430

Primary Examiner—Ted Shooman
Assistant Examiner—Nanda Bondade
Attorney, Agent, or Firm—Gregory P. Kaihoi

[57] **CLAIM**

The ornamental design for a headset, as shown.

DESCRIPTION

FIG. 1 is a perspective view of a headset showing our new design;
 FIG. 2 is a top view thereof;
 FIG. 3 is a front view thereof;
 FIG. 4 is a right side view thereof;
 FIG. 5 is a left side view thereof;
 FIG. 6 is a rear view thereof;
 FIG. 7 is a bottom view thereof;
 FIG. 8 is a perspective view of an alternate embodiment of FIG. 1;
 FIG. 9 is a top view of FIG. 8;
 FIG. 10 is a front view of FIG. 8;
 FIG. 11 is a right side view of FIG. 8;
 FIG. 12 is a left side view of FIG. 8;
 FIG. 13 is a rear view of FIG. 8;
 FIG. 14 is a bottom view of FIG. 8.

1 Claim, 8 Drawing Sheets

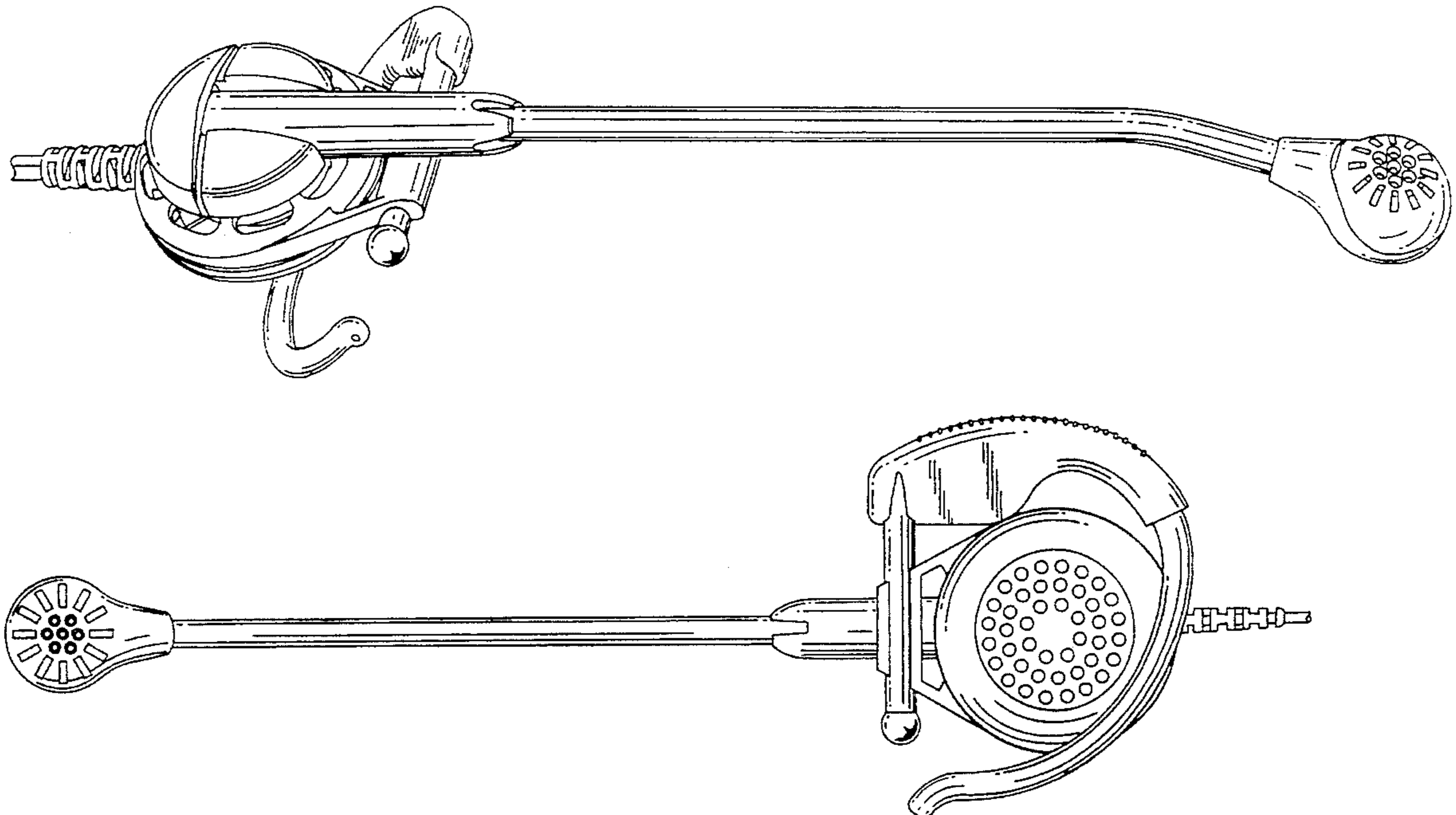

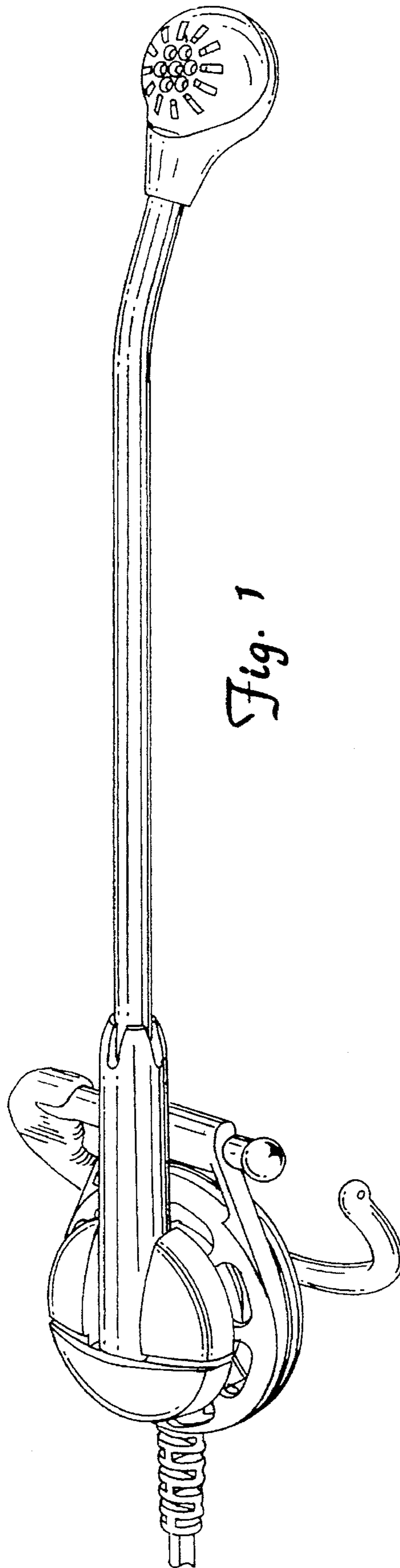

Fig. 1

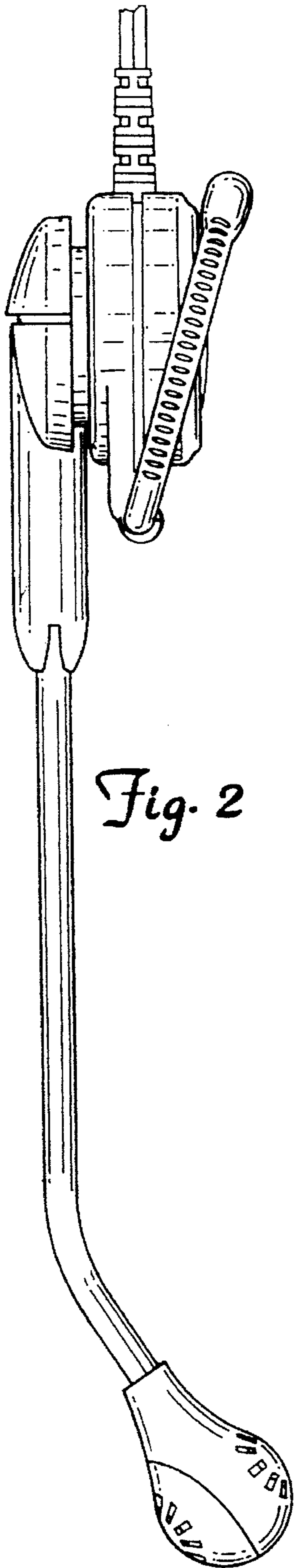

Fig. 2

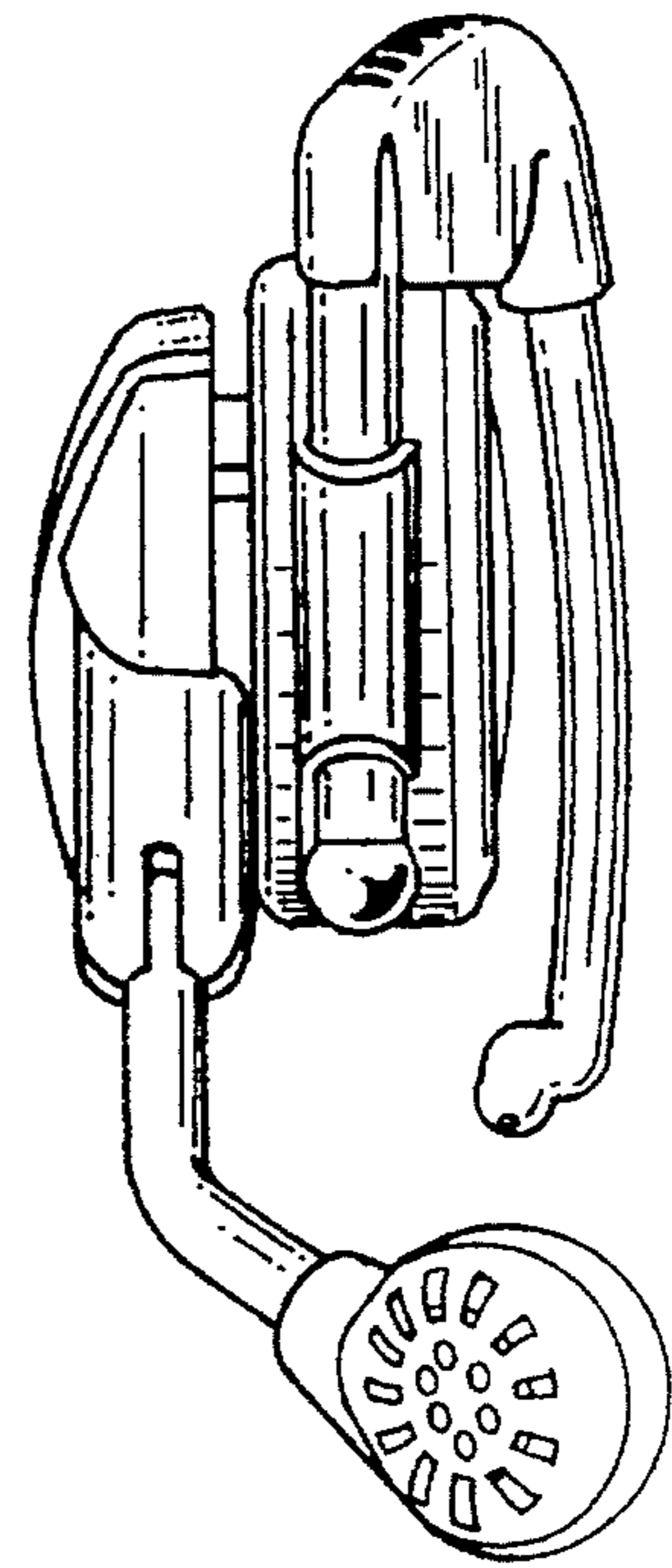

Fig. 3

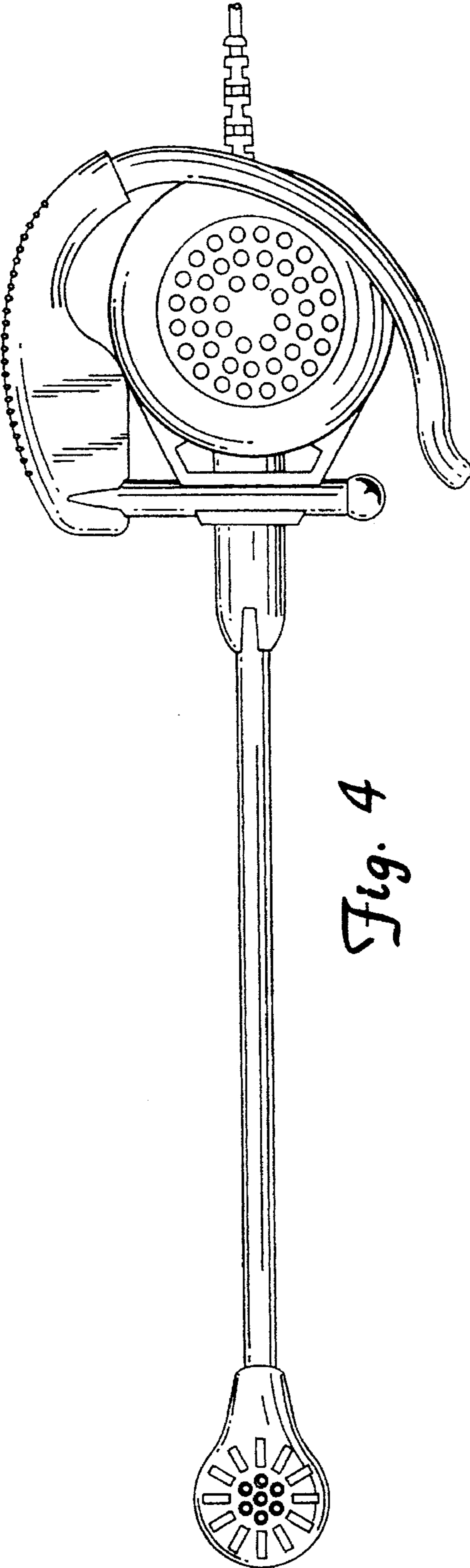

Fig. 4

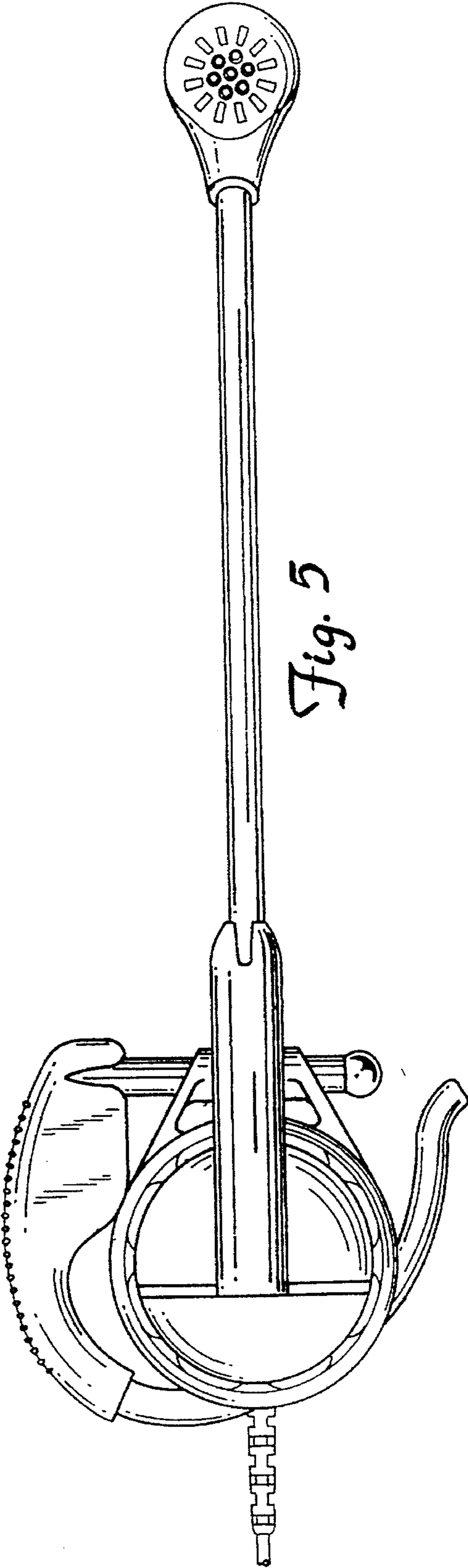

Fig. 5

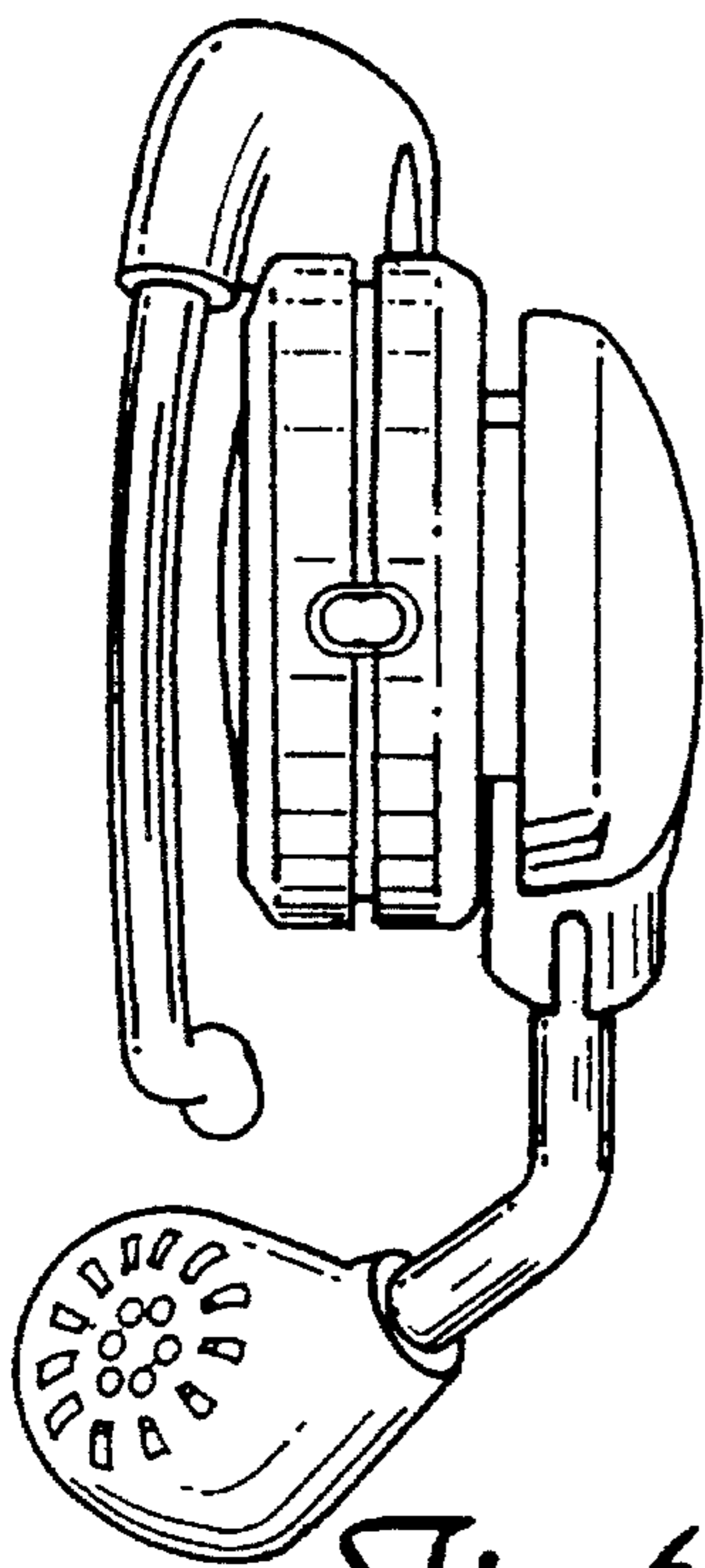

Fig. 6

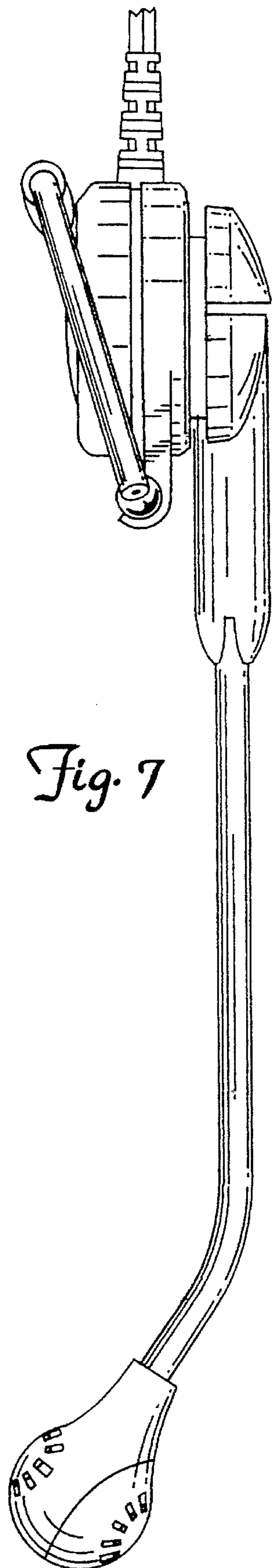

Fig. 7

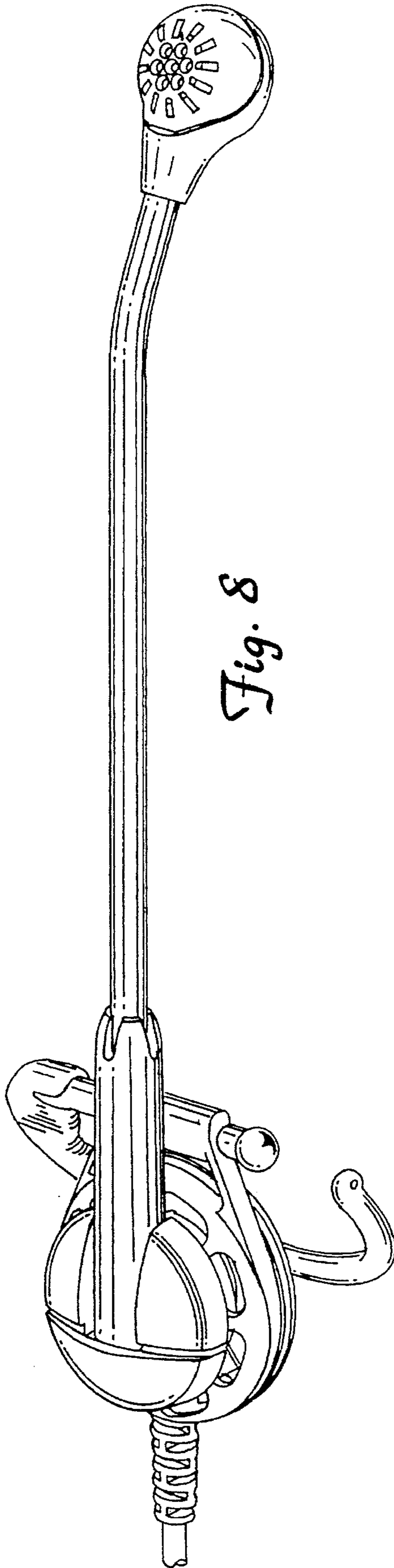

Fig. 8

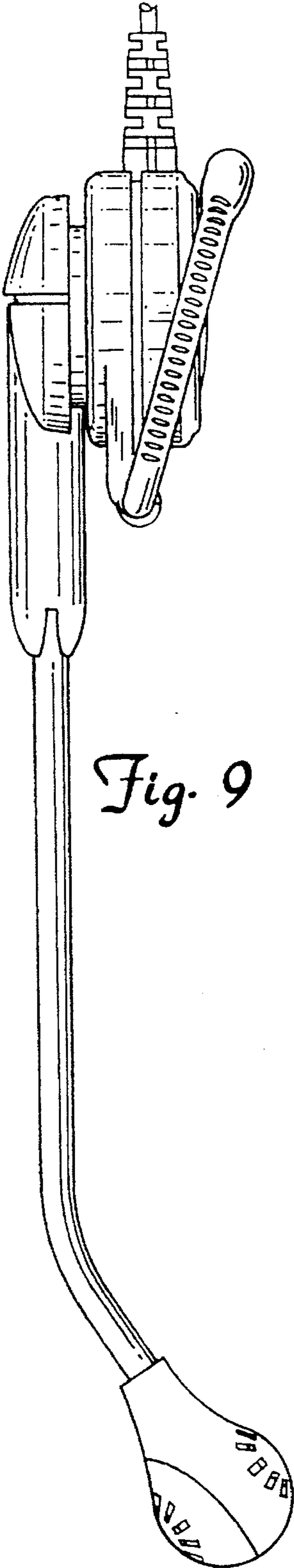

Fig. 9

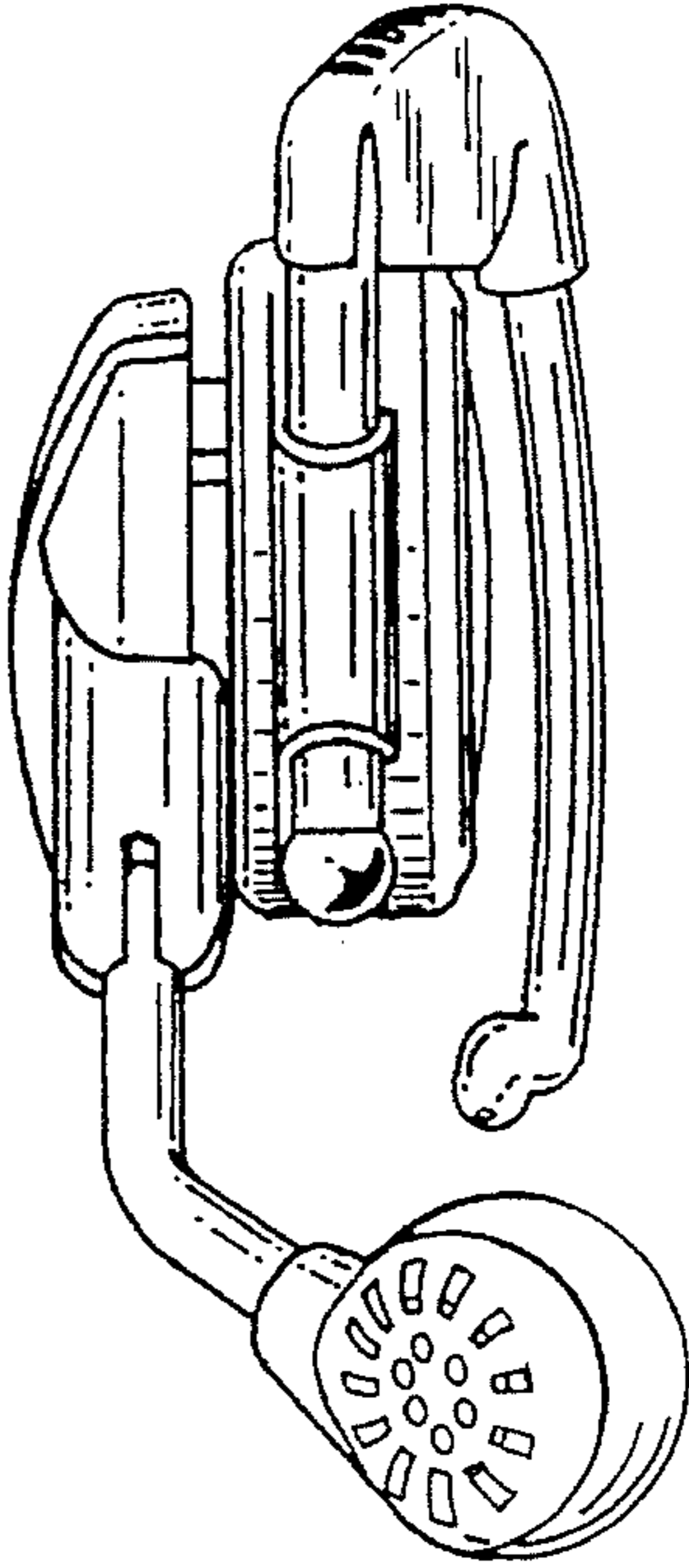

Fig. 10

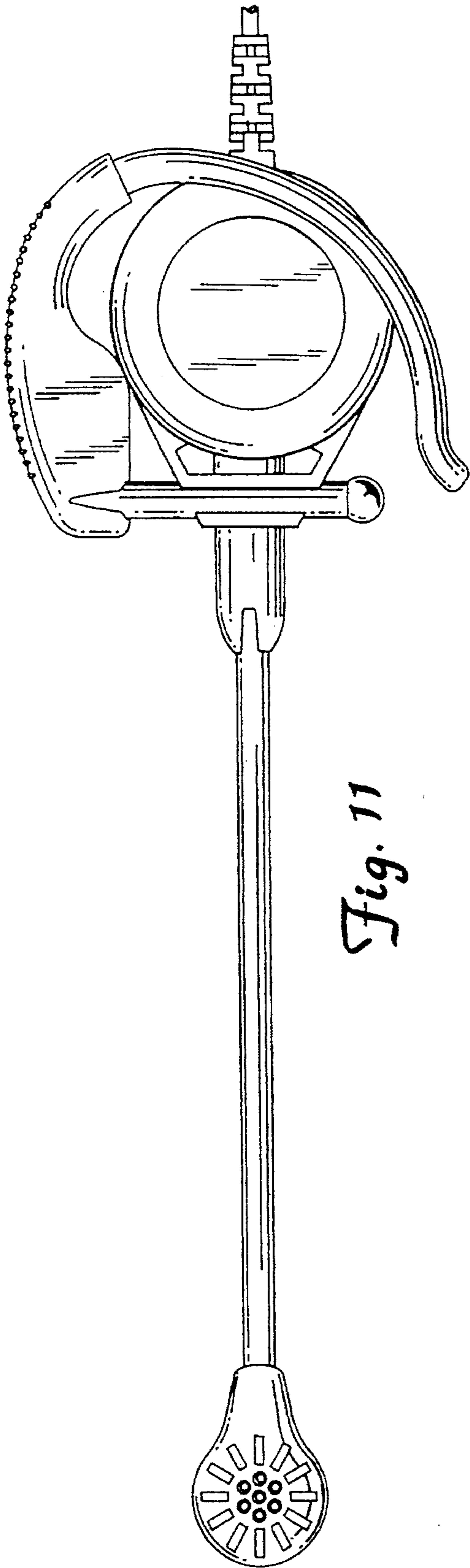

Fig. 11

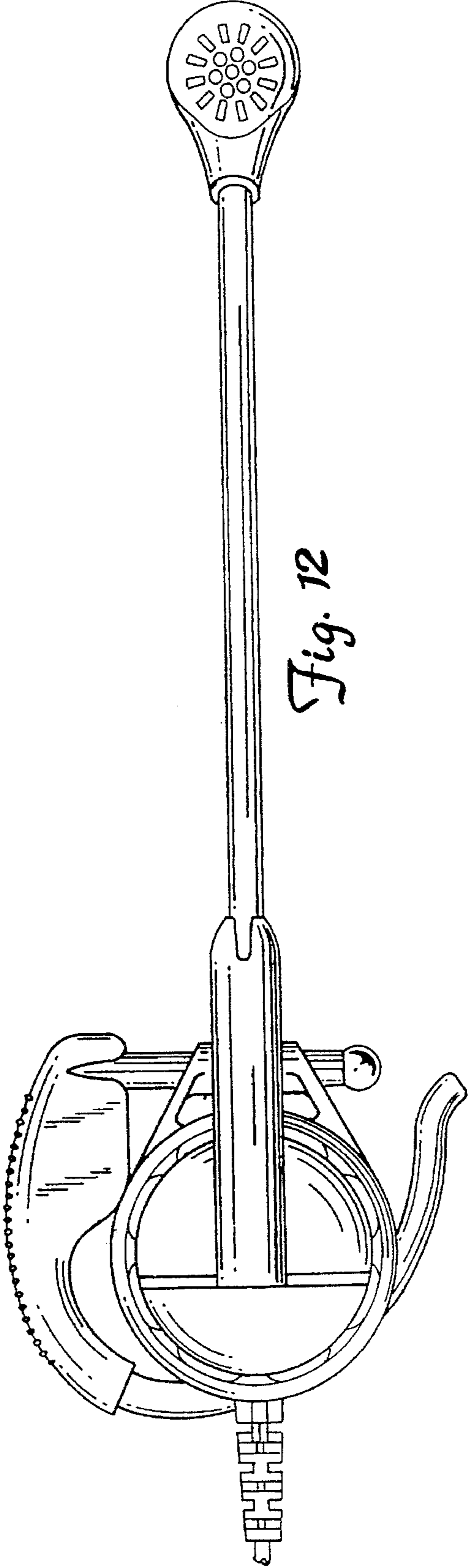

Fig. 12

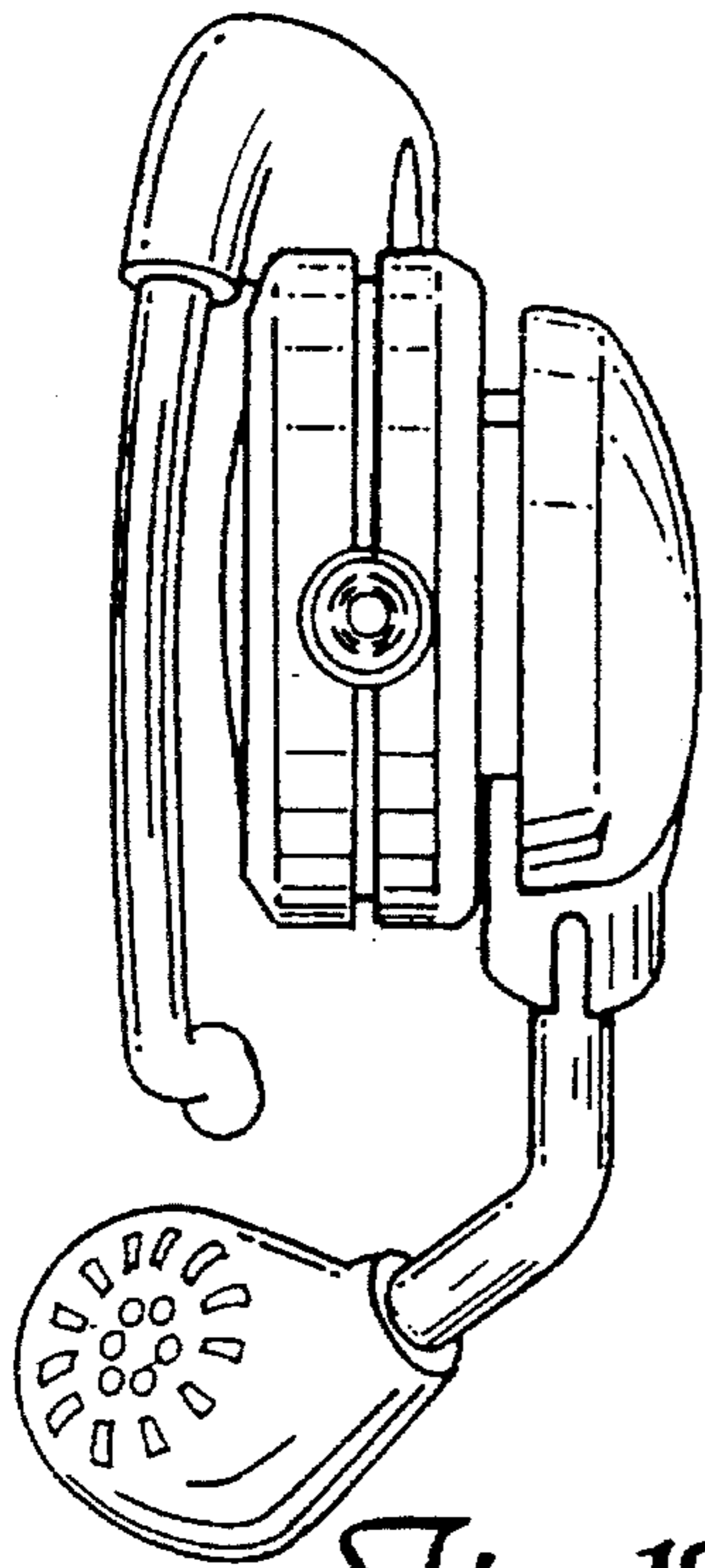

Fig. 13

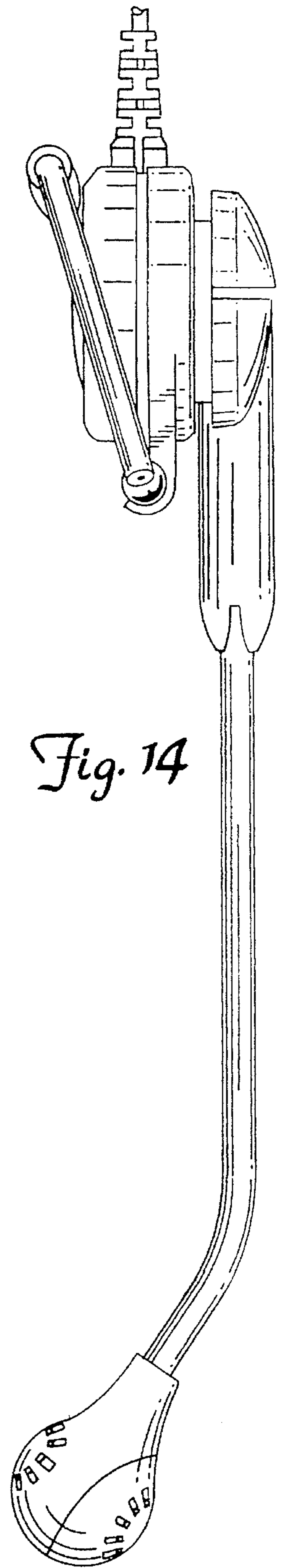

Fig. 14