



US00D366413S

United States Patent [19]
Tober

[11] **Patent Number: Des. 366,413**

[45] **Date of Patent: **Jan. 23, 1996**

[54] **CANISTER**

[76] **Inventor: C. David Tober**, 4092 E. Britain Ave.,
Benton Harbor, Mich. 49022-9727

[**] **Term: 14 Years**

[21] **Appl. No.: 19,139**

[22] **Filed: Feb. 24, 1994**

[52] **U.S. Cl. D9/429**

[58] **Field of Search** D9/428, 429, 337,
D9/338, 541, 542, 543, 555, 556, 569;
206/209, 209.1, 234, 277, 303, 306, 305,
362.2, 15.2, 364, 365, 368, 379, 380; 220/669-675;
D3/201

[56] **References Cited**

U.S. PATENT DOCUMENTS

- D. 56,563 8/1921 Goldberg .
- D. 69,468 2/1926 Vogler D9/424 X
- D. 96,089 7/1935 Botham .
- D. 111,794 8/1938 Oswell .
- D. 153,607 5/1949 Hilby .
- D. 218,222 8/1970 Leibson .
- D. 228,490 10/1973 Bagguley et al. .
- D. 243,975 4/1977 Persson .
- D. 244,509 5/1977 Jones et al. .
- D. 273,365 4/1984 Lukins et al. .
- D. 276,285 11/1984 Tober et al. .
- D. 279,511 7/1985 Matsubara et al. .
- D. 280,032 8/1985 Holloway .
- D. 280,281 8/1985 Conti et al. .
- D. 282,884 3/1986 Byrns .
- D. 284,421 7/1986 Siris .
- D. 295,482 5/1988 Bunge .

- D. 299,315 1/1989 Kasanda .
- D. 322,716 12/1991 Morris et al. .
- 656,914 8/1900 Walsh 206/367
- 1,252,204 1/1918 Valeri 220/671 X
- 2,965,256 4/1959 Yochem .
- 3,508,587 4/1970 Mauch 220/669 X
- 3,901,406 8/1975 Kiuett 220/671 X
- 4,371,091 2/1983 Gelina .

OTHER PUBLICATIONS

Packaging Cat. 1959, p. 119, Item #301.
Modern Packaging, 1948, p. 386.

Primary Examiner—Prabhakar G. Deshmukh
Attorney, Agent, or Firm—Juettner Pyle Lloyd & Piontek

[57] **CLAIM**

The ornamental design for a canister, as shown and described.

DESCRIPTION

FIG. 1 is a perspective view of a canister showing my new design;
 FIG. 2 is a front elevational view thereof. The rear, left and right side elevational views are the same in appearance;
 FIG. 3 is an exploded front elevational view thereof, The rear, right and left side exploded elevational views are the same in appearance;
 FIG. 4 is a top plan view thereof;
 FIG. 5 is a bottom plan view thereof;
 FIG. 6 is a cross-sectional view taken along line 6—6 of FIG. 3; and,
 FIG. 7 is a cross-sectional view taken along line 7—7 of FIG. 3.

1 Claim, 1 Drawing Sheet



Fig.1

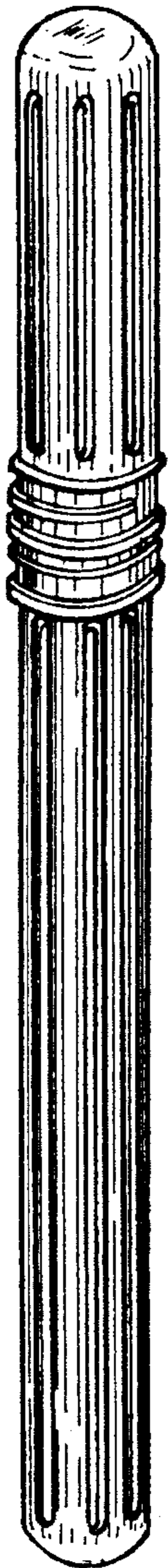

Fig.2

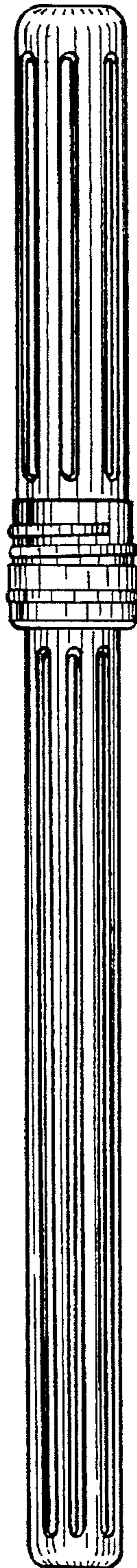

Fig.3

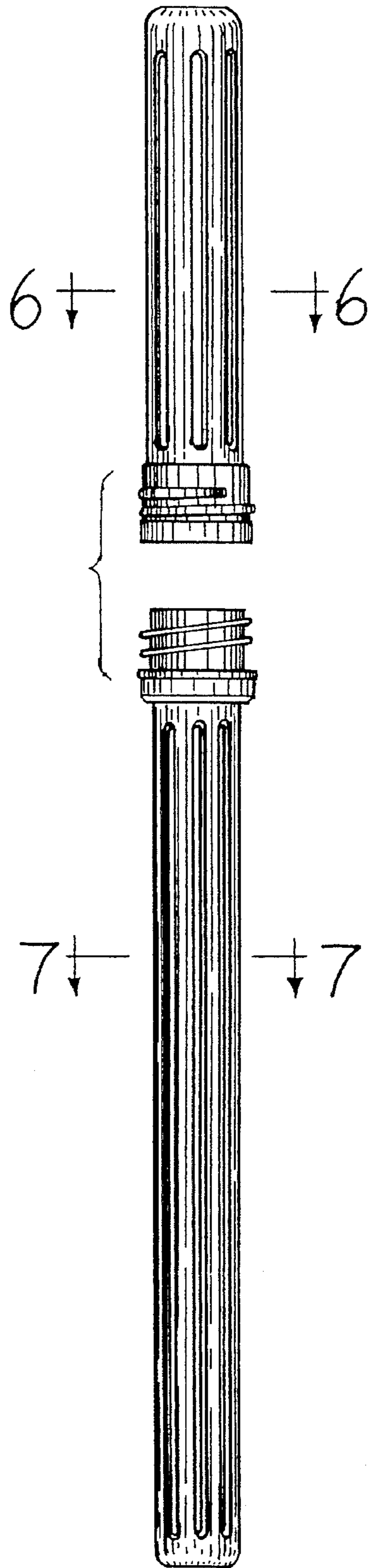

Fig.4

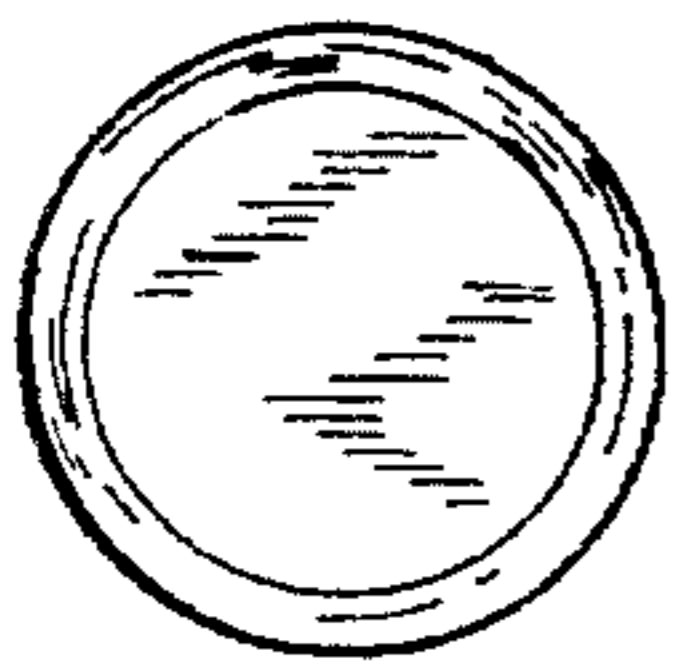

Fig.5

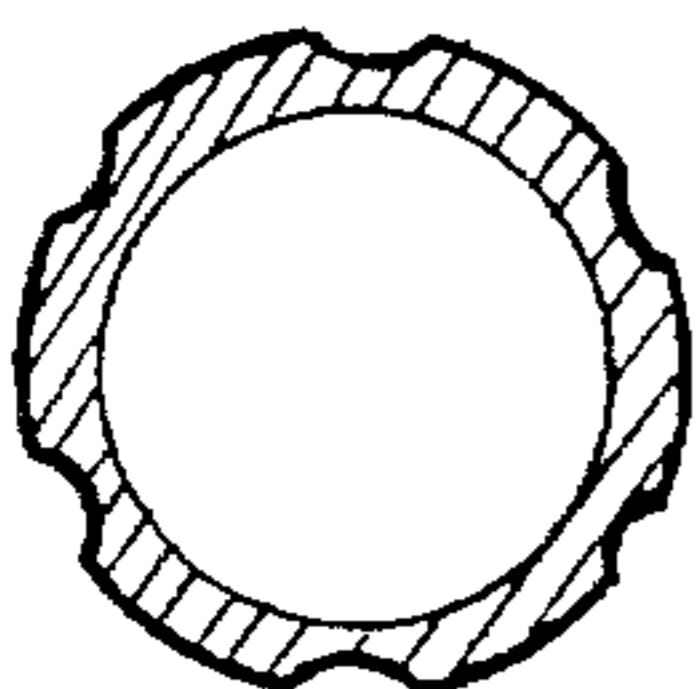
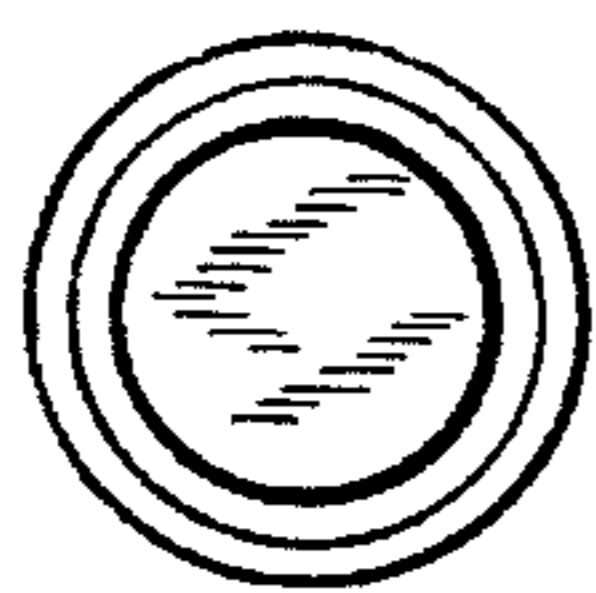

Fig.6

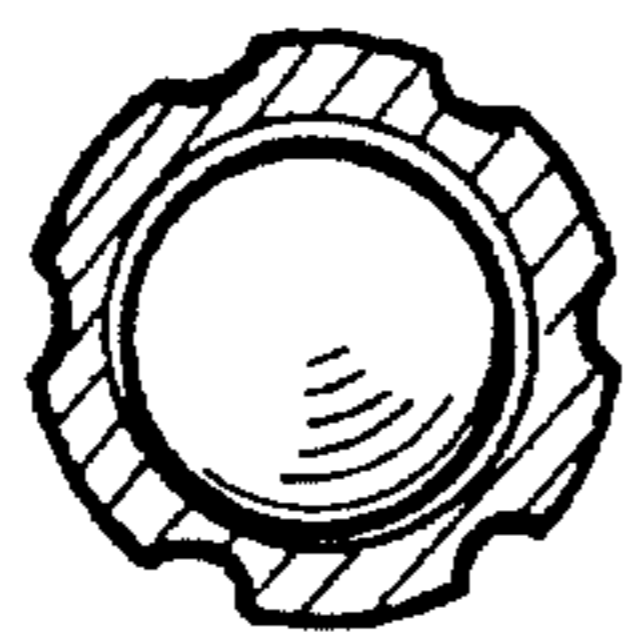

Fig.7