



US00D366278S

United States Patent [19]

Nagashima

[11] Patent Number: **Des. 366,278**

[45] Date of Patent: ****Jan. 16, 1996**

[54] **TONER CARTRIDGE**

D. 310,845 9/1990 Ohata D18/43
D. 346,819 5/1994 Taniguchi et al. D18/43

[75] Inventor: **Takashi Nagashima**, Habikino, Japan

[73] Assignee: **Mita Industrial Co., Ltd.**, Osaka, Japan

Primary Examiner—Carmen H. Vales-Lado
Assistant Examiner—Caron D. Veynar
Attorney, Agent, or Firm—Spencer, Frank & Schneider

[**] Term: **14 Years**

[57] **CLAIM**

[21] Appl. No.: **28,975**

The ornamental design for a toner cartridge, as shown.

[22] Filed: **Sep. 27, 1994**

DESCRIPTION

[30] **Foreign Application Priority Data**

Apr. 15, 1994 [JP] Japan 6-10859

[52] **U.S. Cl.** **D18/43**; D18/40; 222/166; 222/325

[58] **Field of Search** D18/36, 40, 43; 141/1; 118/657; 206/216, 446, 461; 222/DIG. 1, 166, 325, 541, 240; 355/260, 298

FIG. 1 is a top plan view of a toner cartridge;
FIG. 2 is a front elevational view of a toner cartridge;
FIG. 3 is a left side elevational view of a toner cartridge;
FIG. 4 is a right side elevational view of a toner cartridge;
FIG. 5 is a bottom plan view of a toner cartridge;
FIG. 6 is a rear elevational view of a toner cartridge; and,
FIG. 7 is a top, front and left side perspective view of a toner cartridge.

[56] **References Cited**

U.S. PATENT DOCUMENTS

D. 310,844 9/1990 Ohata D18/43

1 Claim, 4 Drawing Sheets

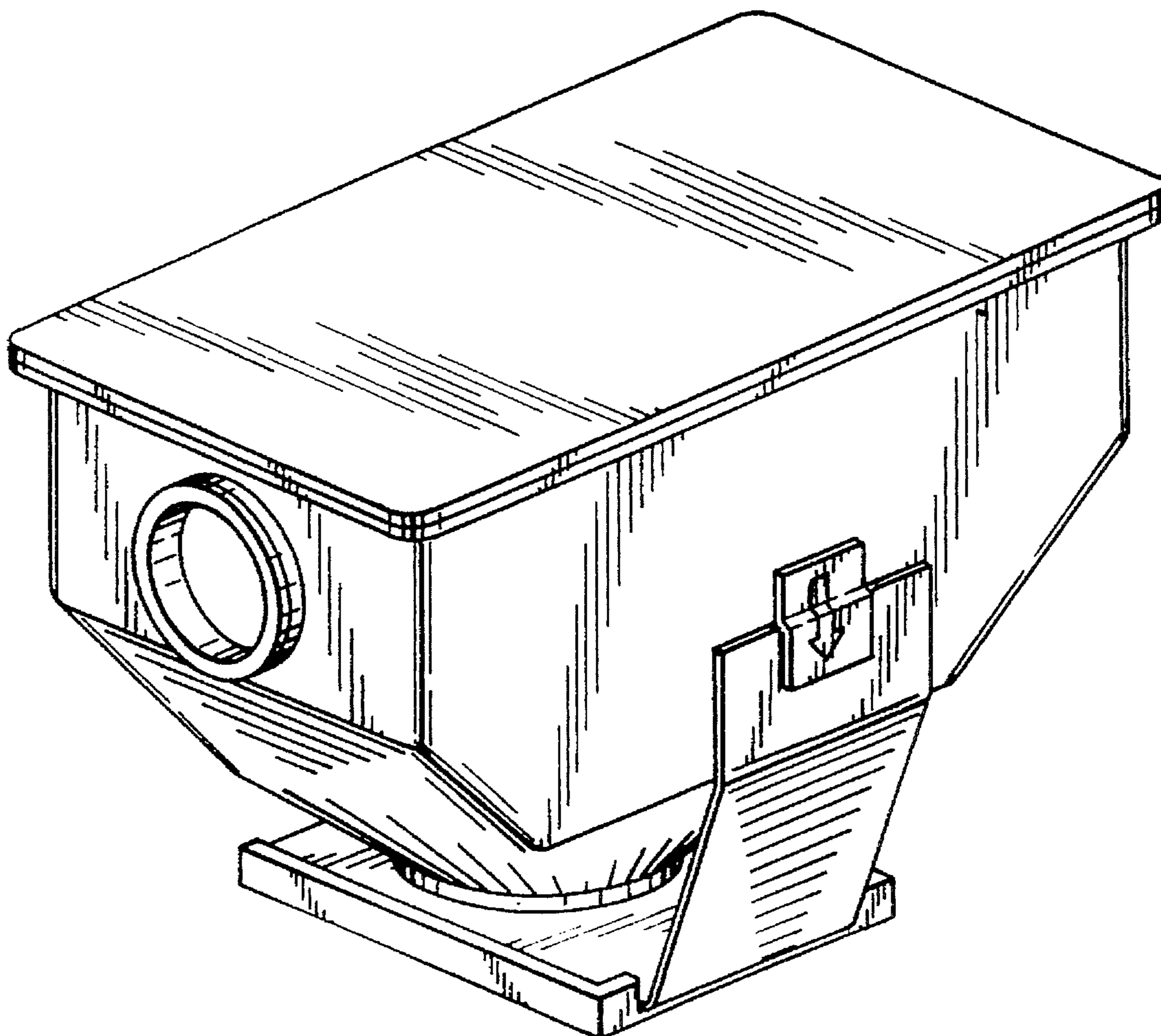

FIG. 1

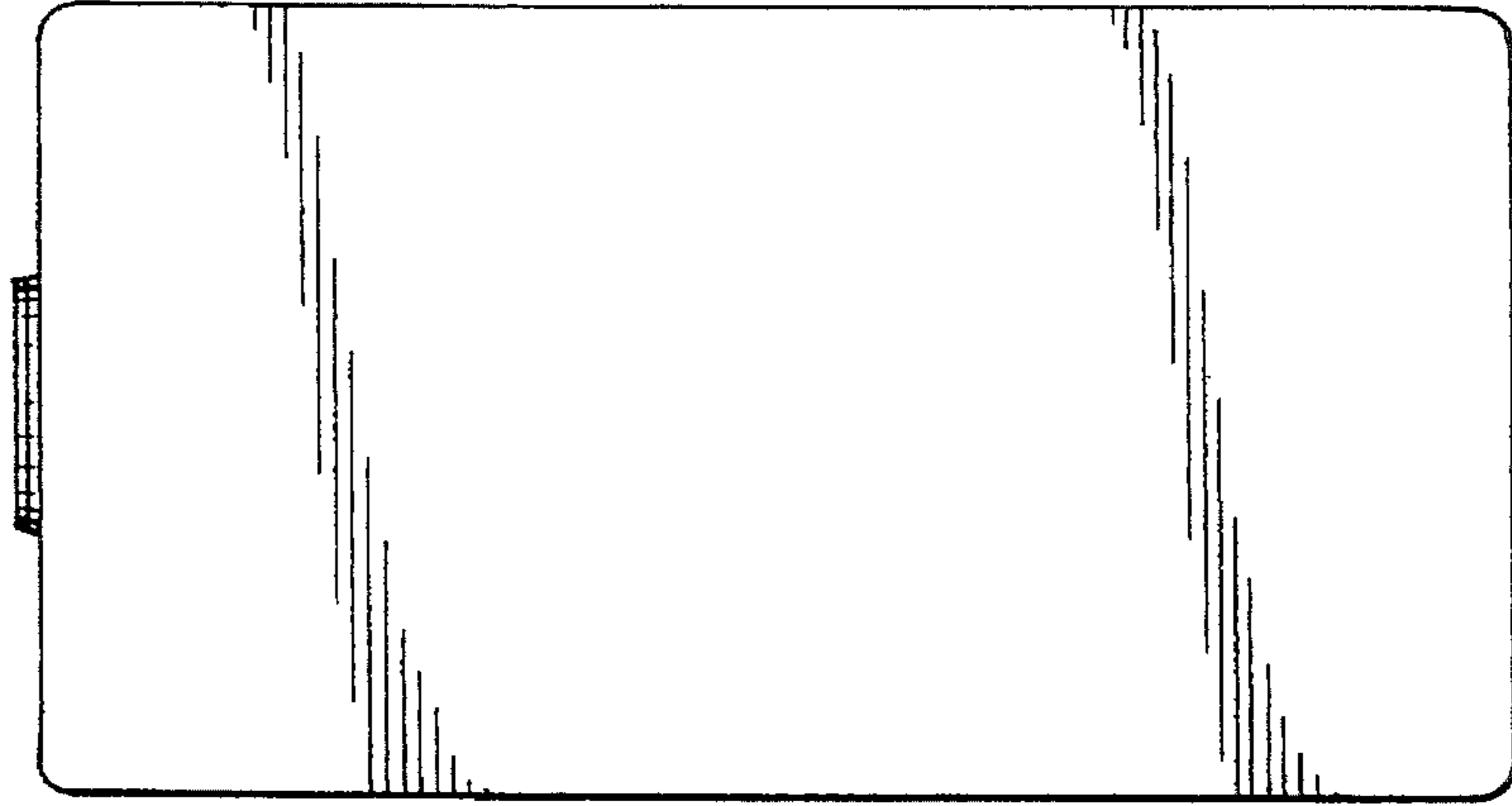

FIG. 2

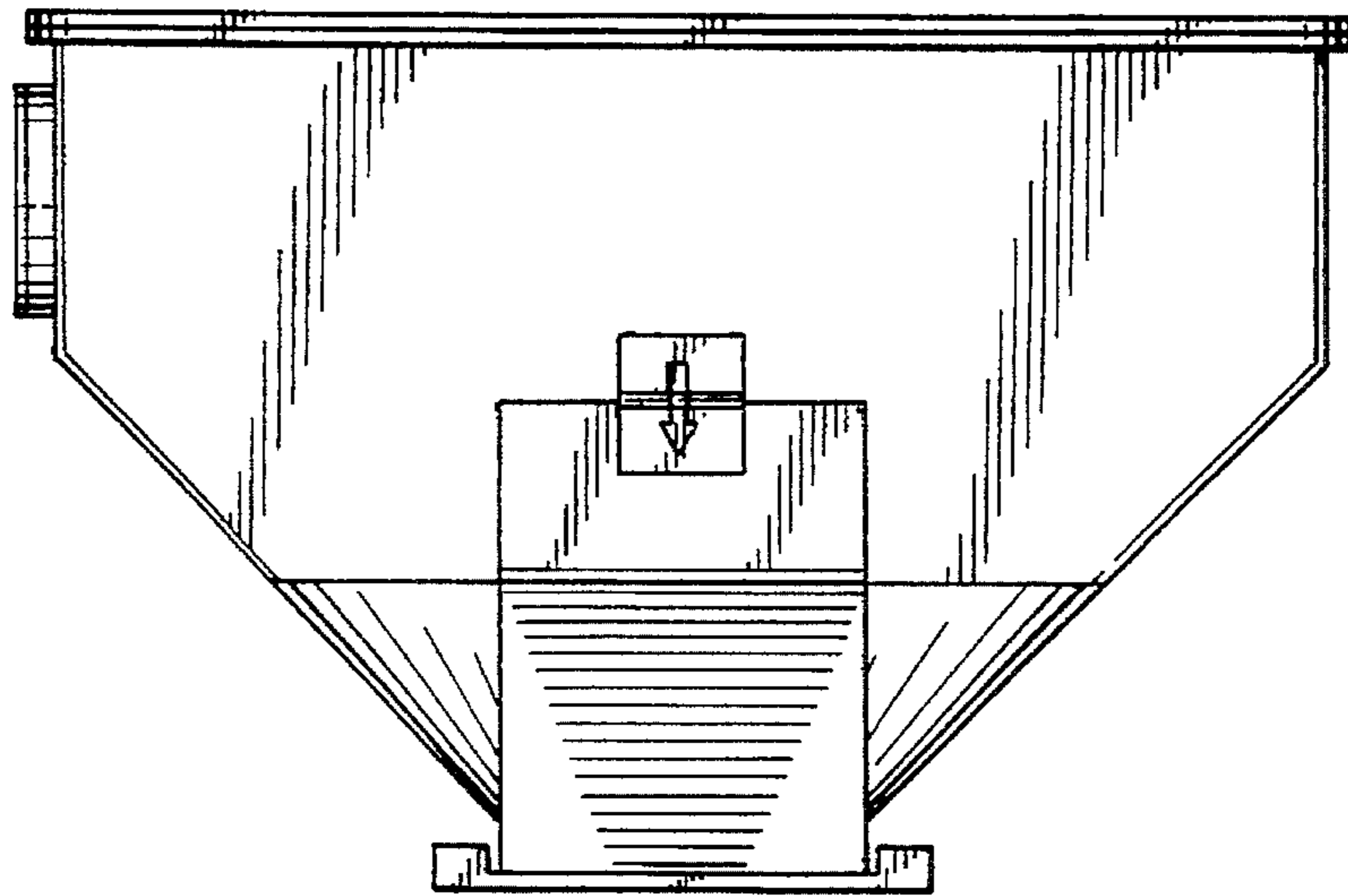

FIG. 3

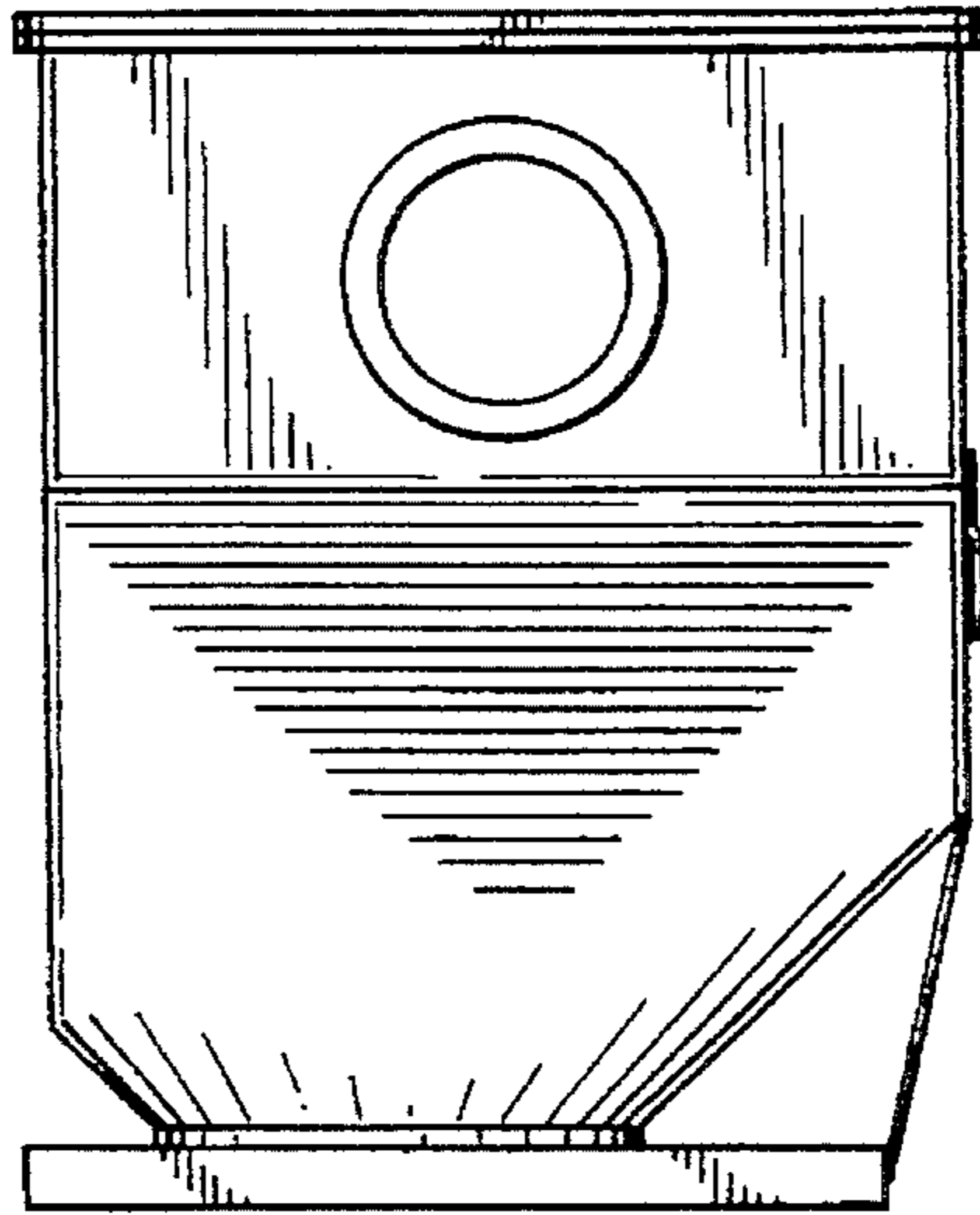

FIG. 4

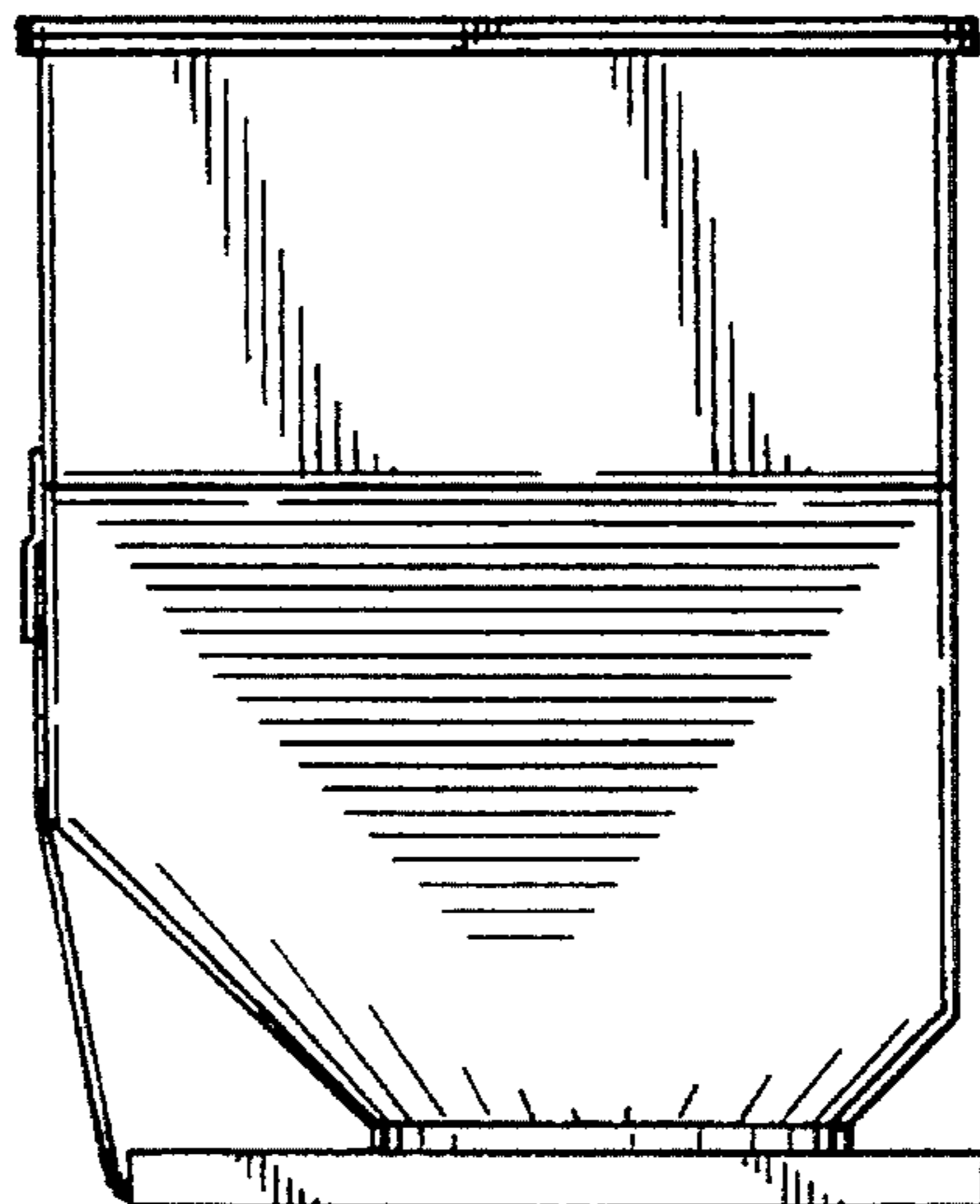

FIG. 5

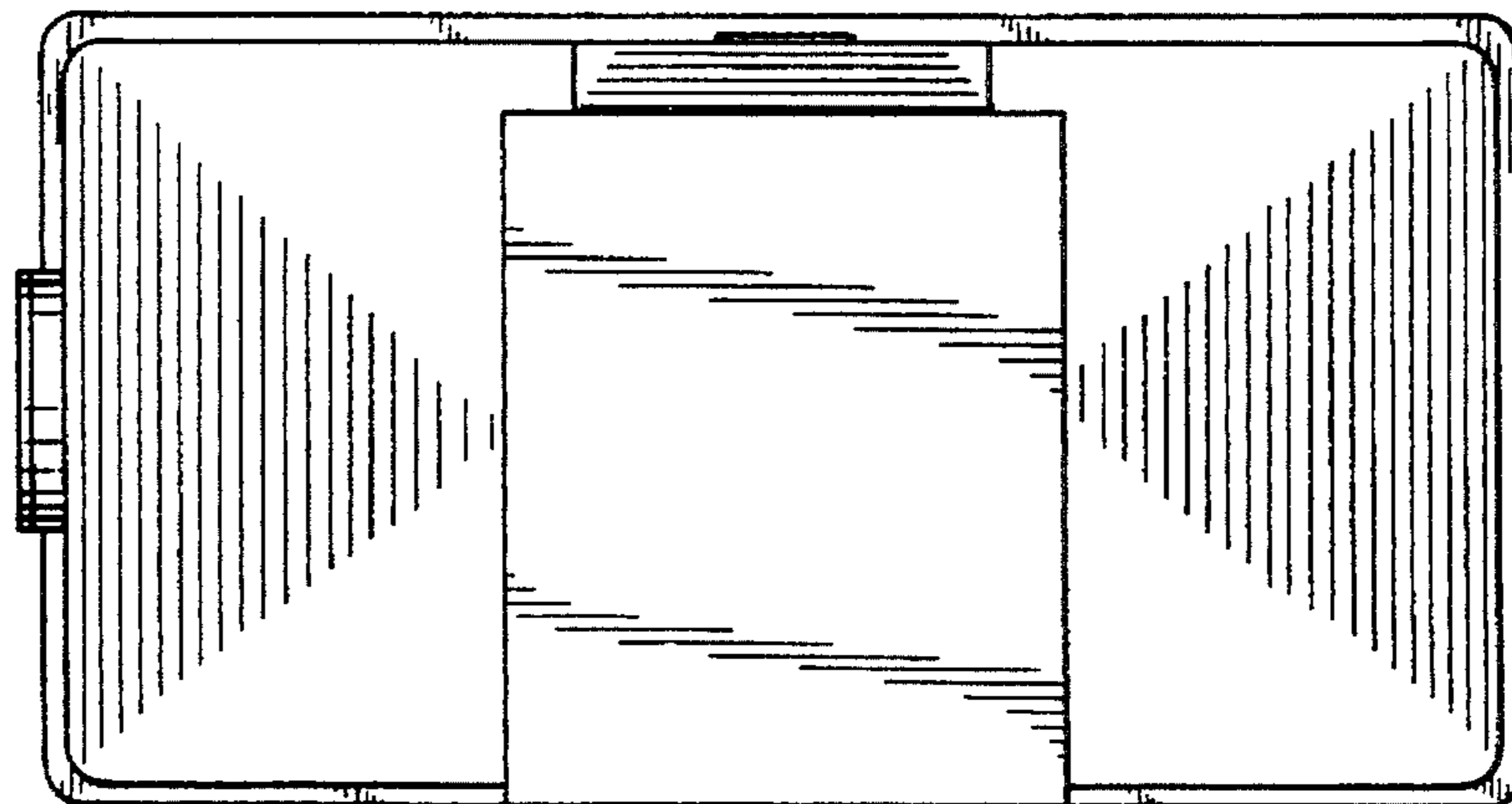

FIG. 6

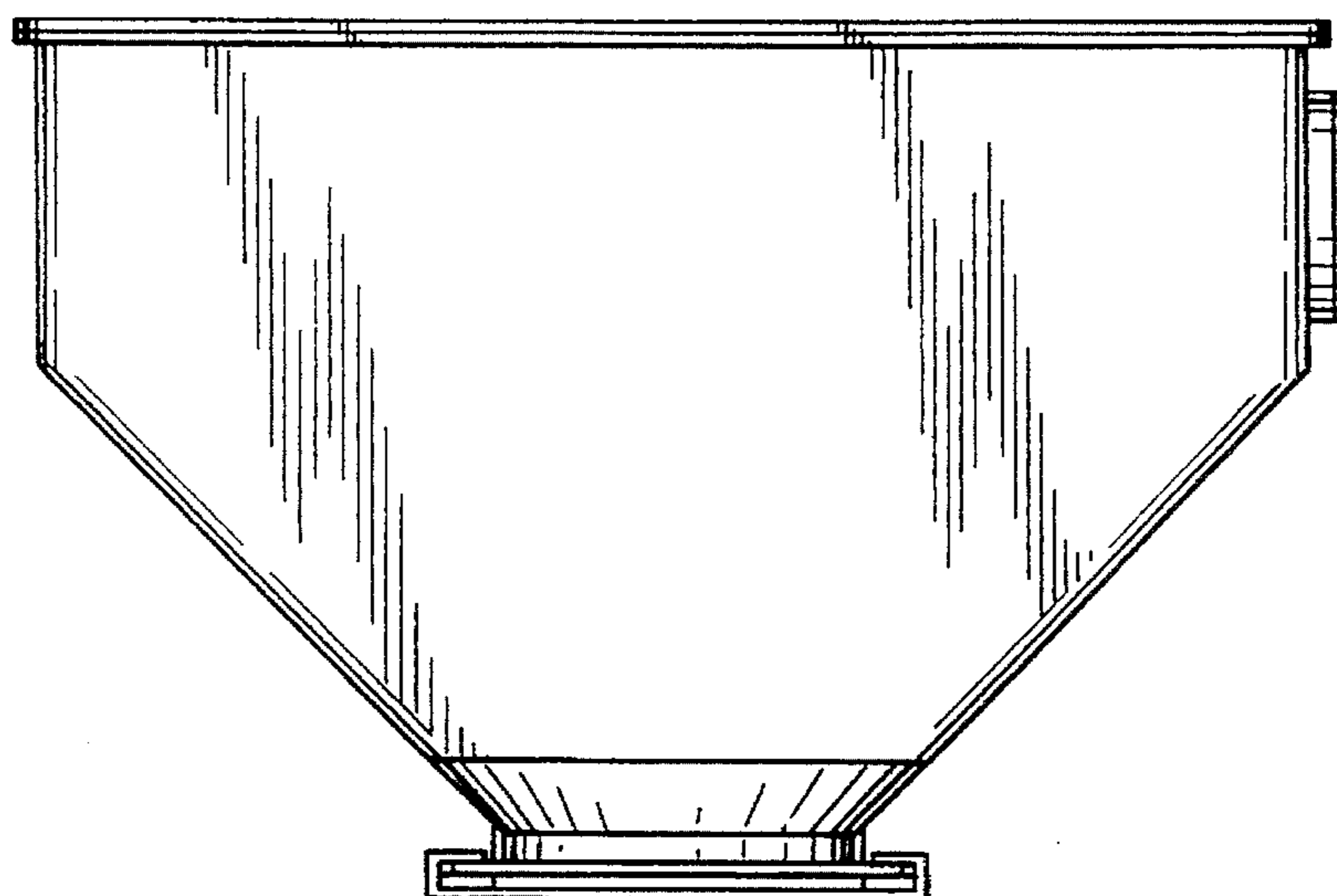

FIG. 7

