



US00D366261S

# United States Patent [19]

Splane, Jr. et al.

[11] Patent Number: Des. 366,261

[45] Date of Patent: \*\*Jan. 16, 1996

[54] **CONTROLLER FOR VIDEO EDITING**

[75] Inventors: **Robson L. Splane, Jr.**, Granada Hills; **Herbert H. Dow**, Chatsworth; **William P. Debley, Jr.**, North Hills; **Sean M. Montgomery**, Santa Barbara; **Anthony Schmitz**, North Hollywood; **Andrew H. Maltz**, Sherman Oaks; **Donald Kravits**, Los Angeles, all of Calif.

[73] Assignee: **Ediflex Digital Systems, Inc.**, Glendale, Calif.

[\*\*] Term: **14 Years**

[21] Appl. No.: **30,537**

[22] Filed: **Nov. 1, 1994**

[52] U.S. Cl. .... **D14/217; D21/48**

[58] Field of Search ..... D14/125, 217, D14/239, 299, 159; D21/13, 48; 273/148 B, 433-438, DIG. 28; D18/6, 7, 11; 358/311, 312, 452, 453

[56] **References Cited**

**U.S. PATENT DOCUMENTS**

D. 338,016 8/1993 Mohri ..... D14/239

D. 343,622 1/1994 Hanke ..... D14/239 X  
D. 351,599 10/1994 Chui et al. .... D14/217  
D. 355,195 2/1995 Burke ..... D14/217  
4,815,733 3/1989 Yokoi ..... 273/438  
5,375,831 12/1994 Hsien-Chung ..... 273/148 B

*Primary Examiner*—Prabhakar G. Deshmukh  
*Attorney, Agent, or Firm*—Marshall, O'Toole, Gerstein, Murray & Borun

[57] **CLAIM**

The ornamental design for a controller for video editing, as shown and described.

**DESCRIPTION**

FIG. 1 is a perspective view taken from the front and left side of a controller for video editing showing our new design;  
FIG. 2 is a perspective view taken from the front and right side thereof;  
FIG. 3 is a top plan view thereof;  
FIG. 4 is a front elevational view thereof;  
FIG. 5 is a rear elevational view thereof;  
FIG. 6 is a right side elevational view thereof;  
FIG. 7 is a left side elevational view thereof; and,  
FIG. 8 is a bottom plan view thereof.

**1 Claim, 6 Drawing Sheets**

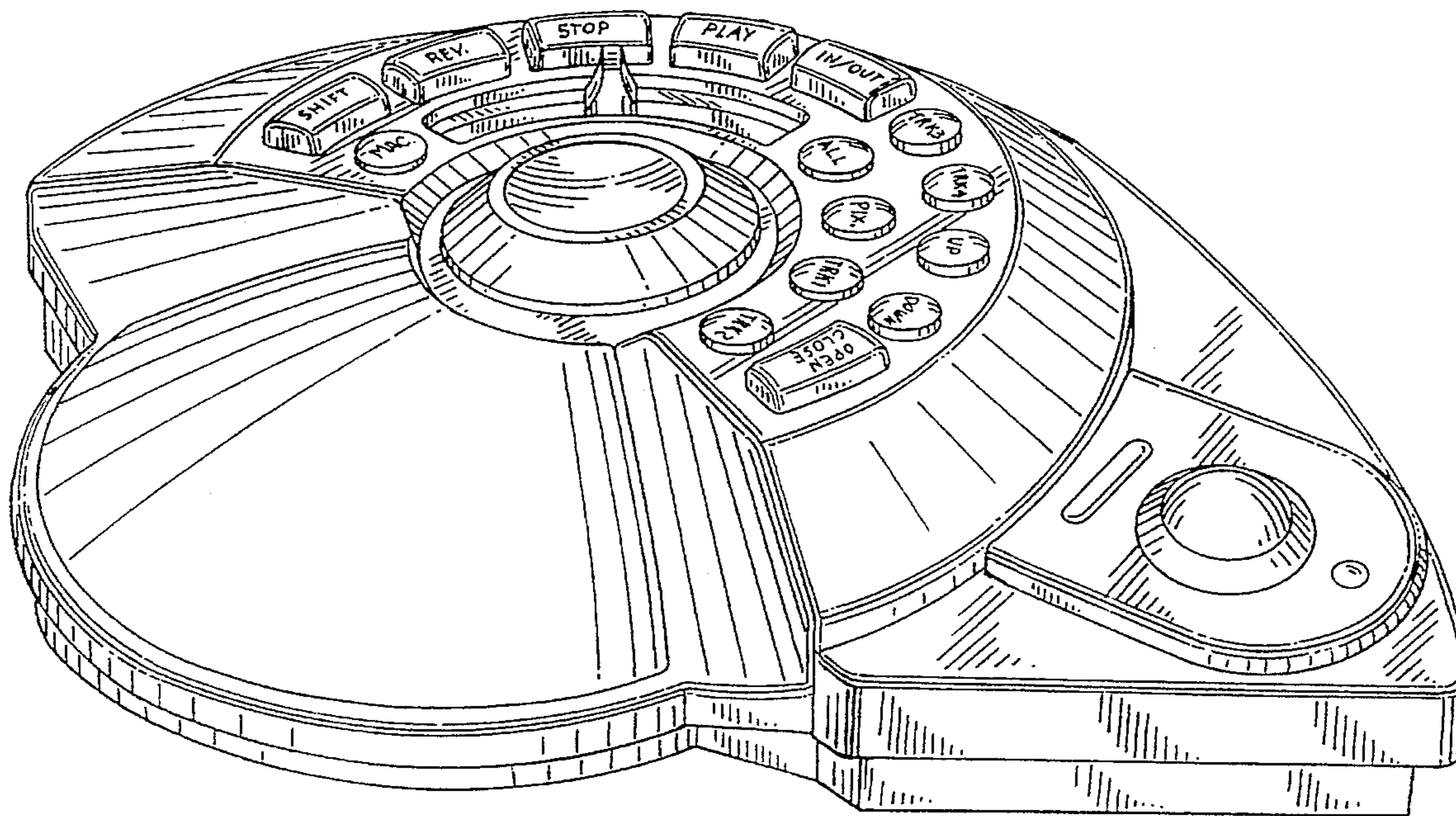
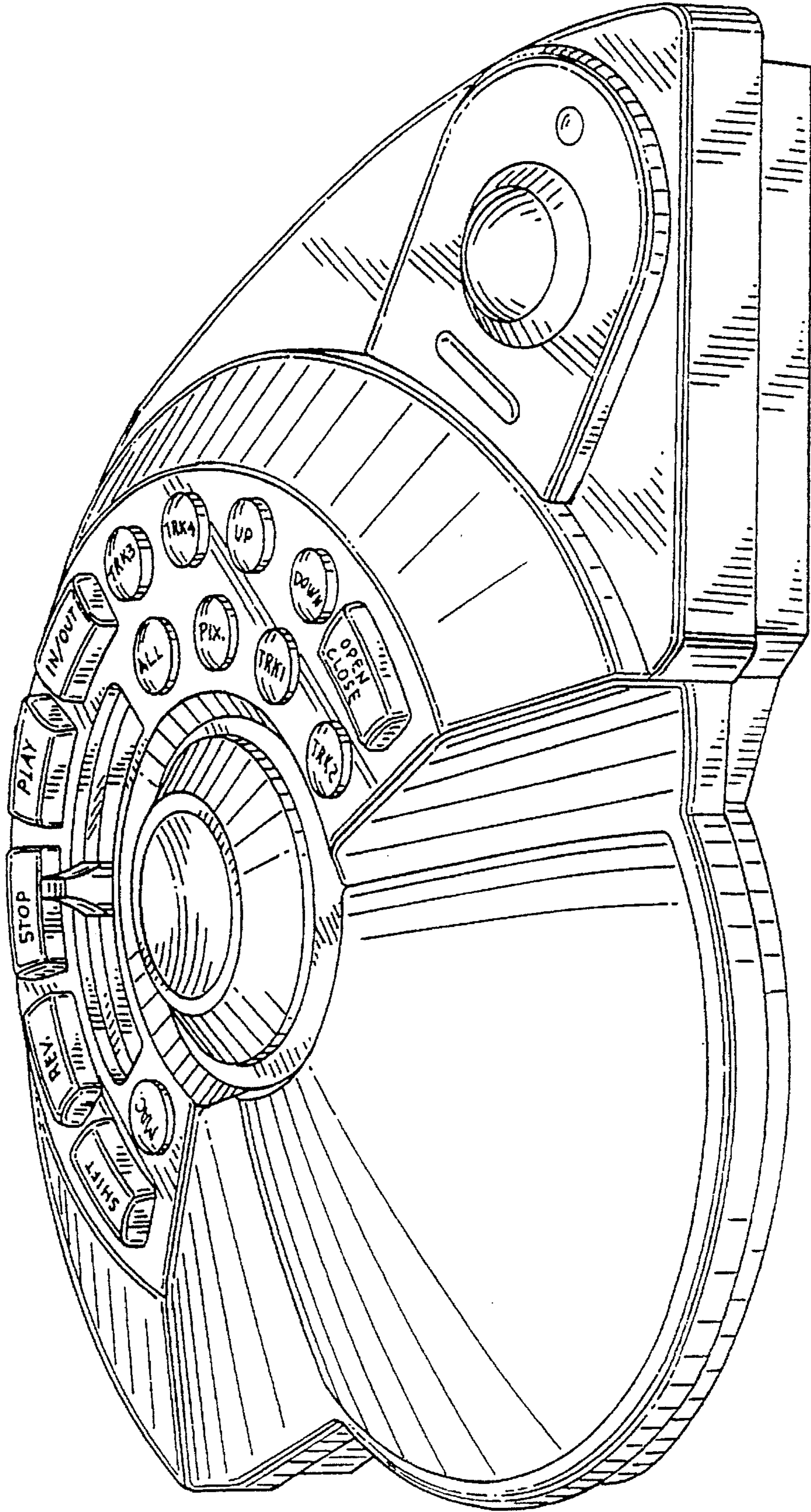

FIG. 1



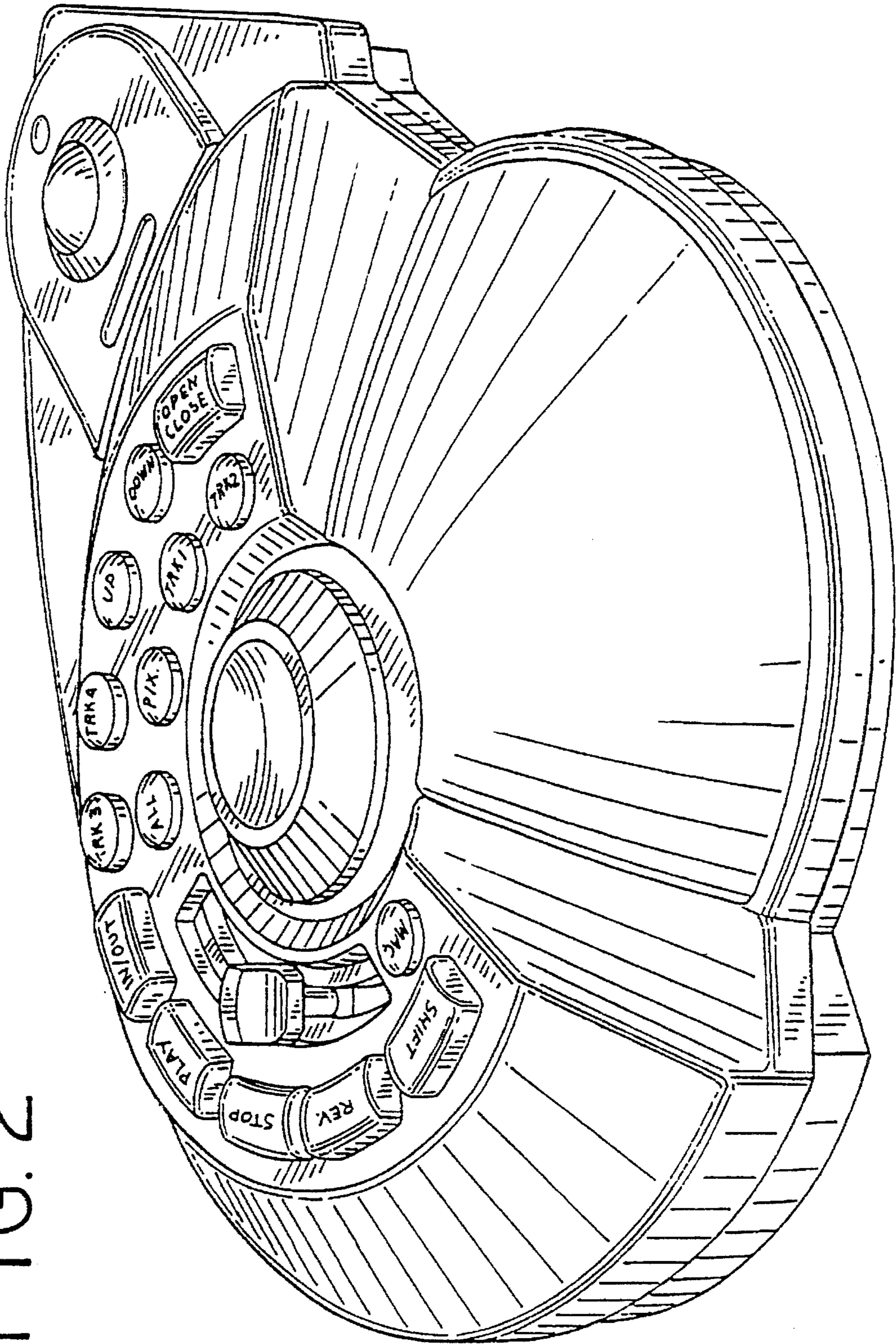

FIG. 2

FIG. 3

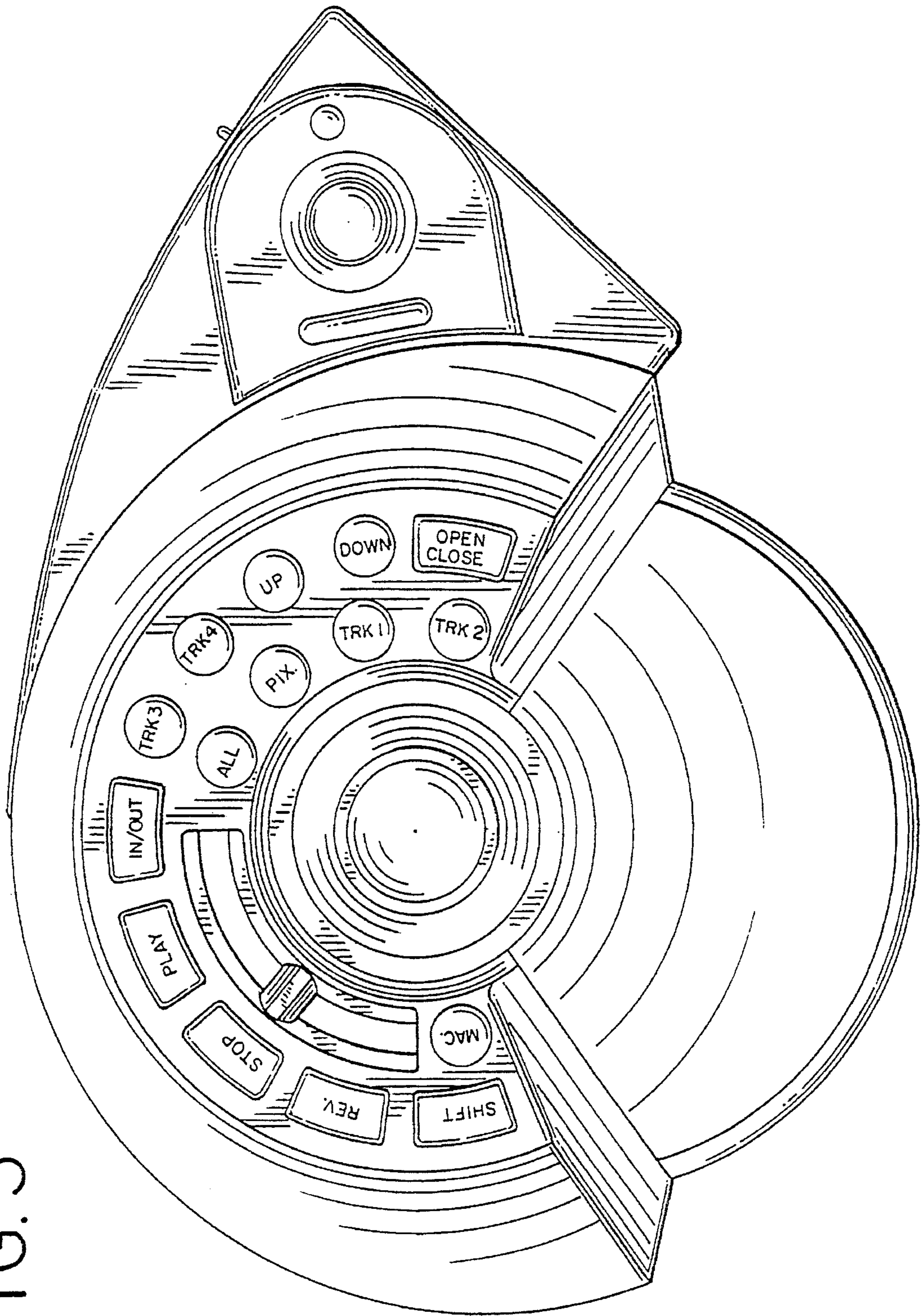

FIG. 4

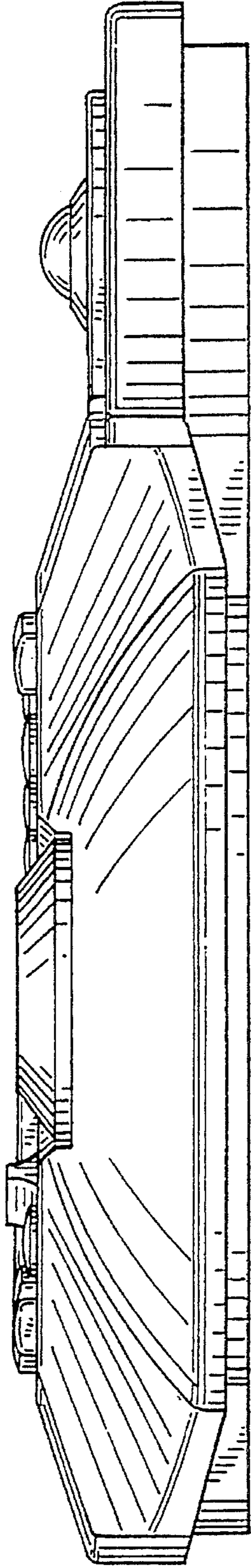

FIG. 5

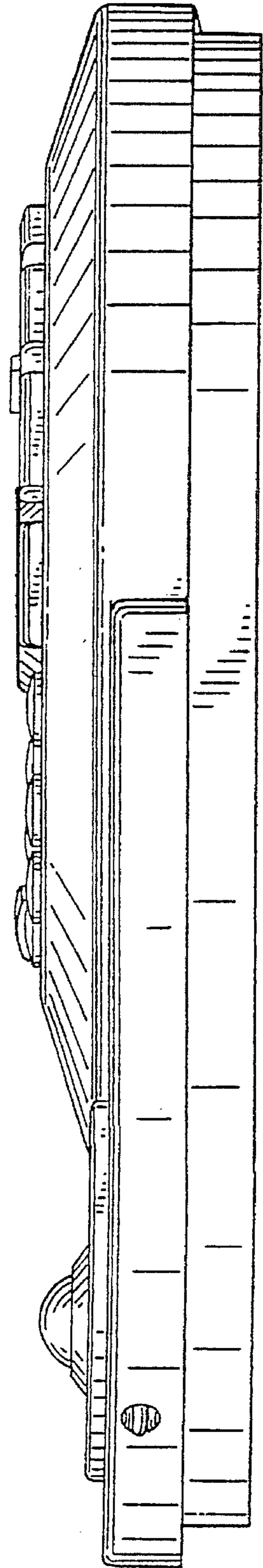

FIG. 6

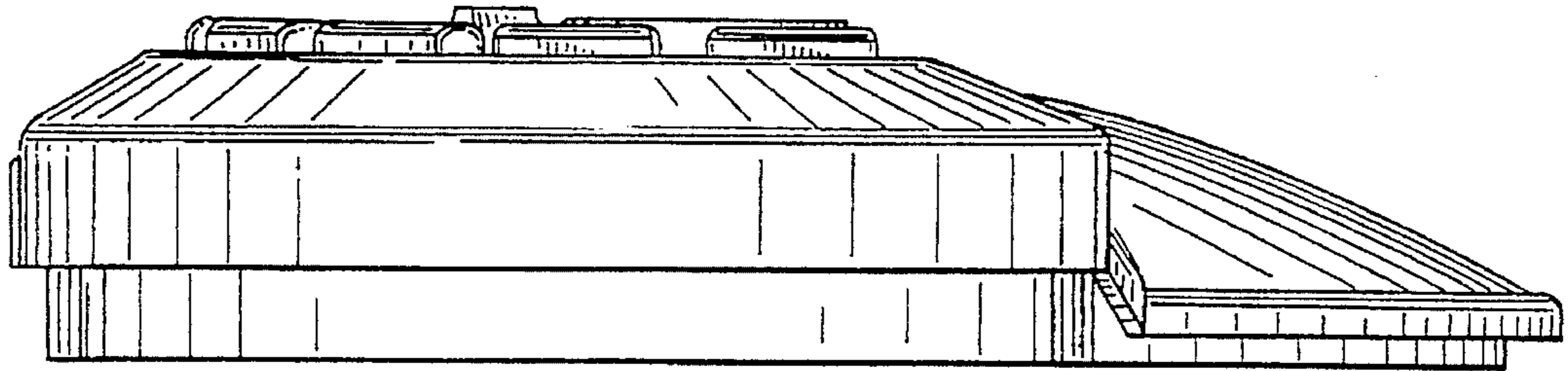
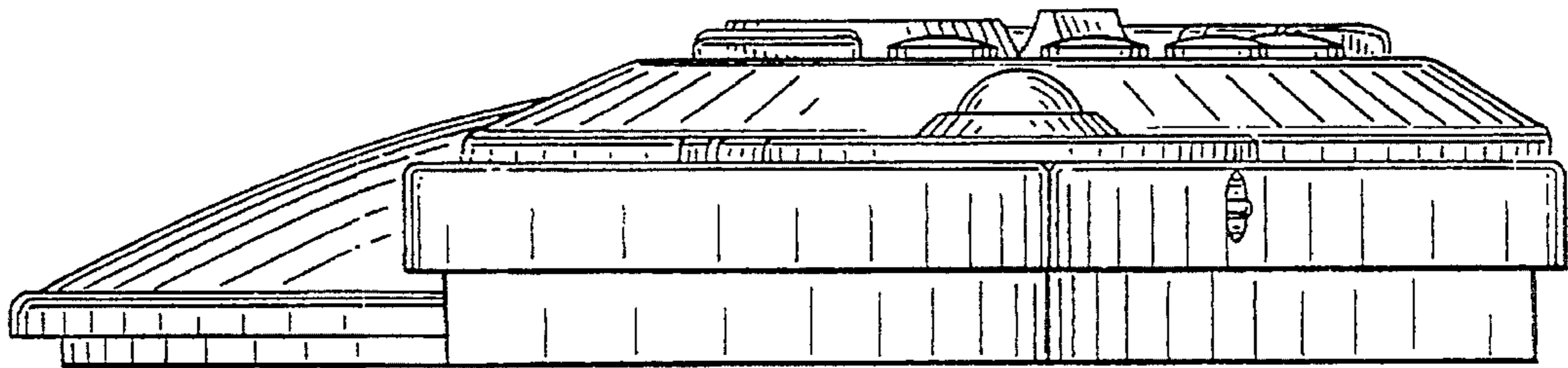

FIG. 7



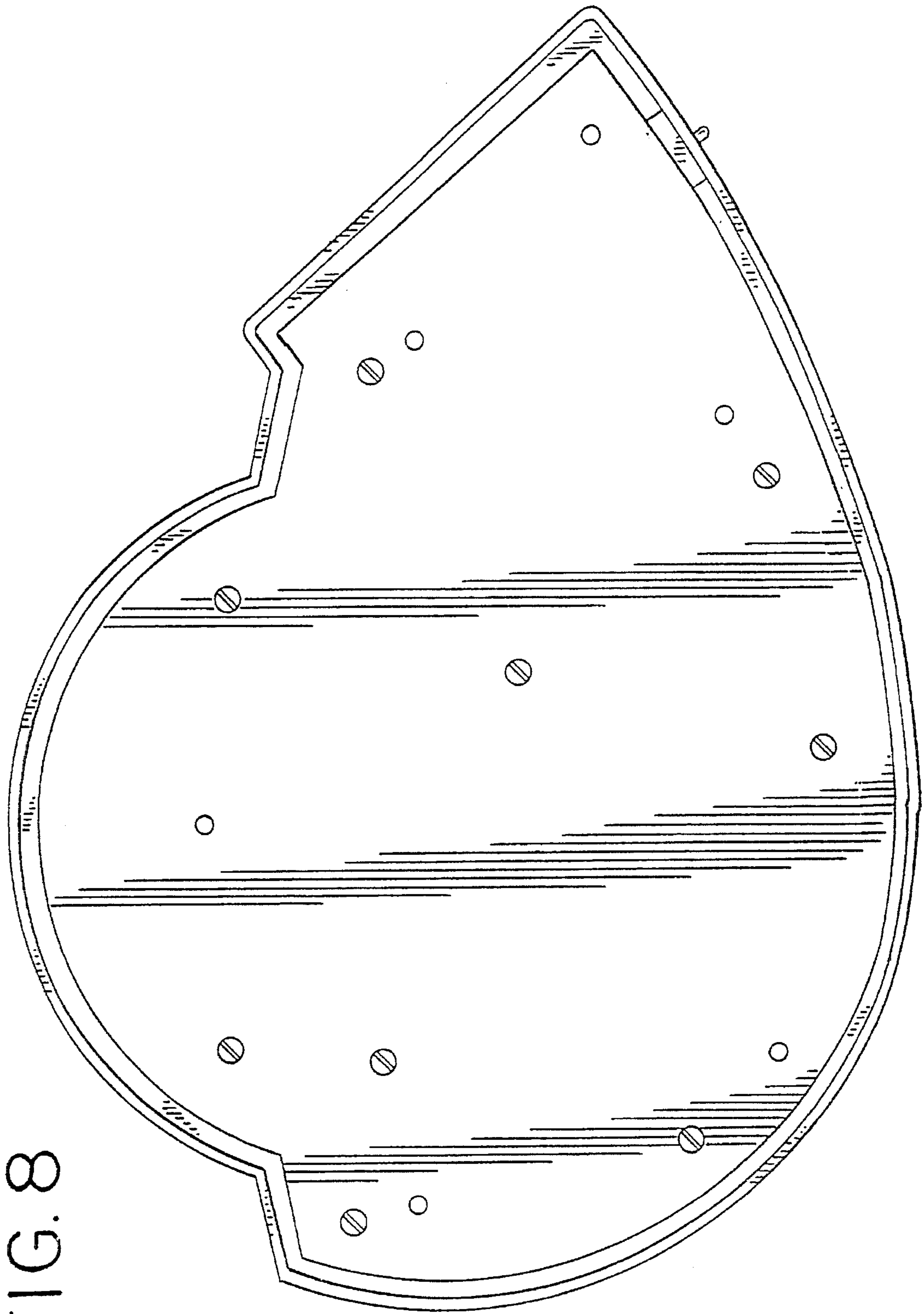

FIG. 8