



US00D366207S

United States Patent [19]

[11] Patent Number: Des. 366,207

Thompson

[45] Date of Patent: **Jan. 16, 1996

[54] STORE DISPLAY BRACKET

[57] CLAIM

[75] Inventor: David G. Thompson, Toledo, Ohio

The ornamental design for a store display bracket, as shown and described.

[73] Assignee: Valley Plastic Co., Ltd., Perrysburg, Ohio

DESCRIPTION

[**] Term: 14 Years

FIG. 1 is a top right perspective view of a store display bracket showing my new design;
 FIG. 2 is a front elevational view thereof;
 FIG. 3 is a right side elevational view thereof, with the left elevational view being a mirror image thereof;
 FIG. 4 is a rear elevational view thereof;
 FIG. 5 is a top plan view thereof;
 FIG. 6 is a bottom view thereof;
 FIG. 7 is a top right perspective view of a store display bracket showing a modified embodiment of my new design;
 FIG. 8 is a front elevational view thereof;
 FIG. 9 is a right side elevational view thereof, with the left side elevational view being a mirror image thereof;
 FIG. 10 is a rear elevational view thereof;
 FIG. 11 is a top plan view thereof; and,
 FIG. 12 is a bottom view thereof.

[21] Appl. No.: 34,897

[22] Filed: Feb. 15, 1995

[52] U.S. Cl. D8/373; D20/43

[58] Field of Search D8/373; D20/43; D6/466; 248/214, 220.2, 222.2, 220.3; D25/119

[56] References Cited

U.S. PATENT DOCUMENTS

4,026,508	5/1977	Ziegler	248/220.3
4,436,209	3/1984	Thalenfeld	248/222.2 X
4,708,311	11/1987	Clausen et al.	248/222.2

Primary Examiner—A. Hugo Word

Assistant Examiner—Holly Baynham

Attorney, Agent, or Firm—MacMillan, Sobanski & Todd

1 Claim, 1 Drawing Sheet

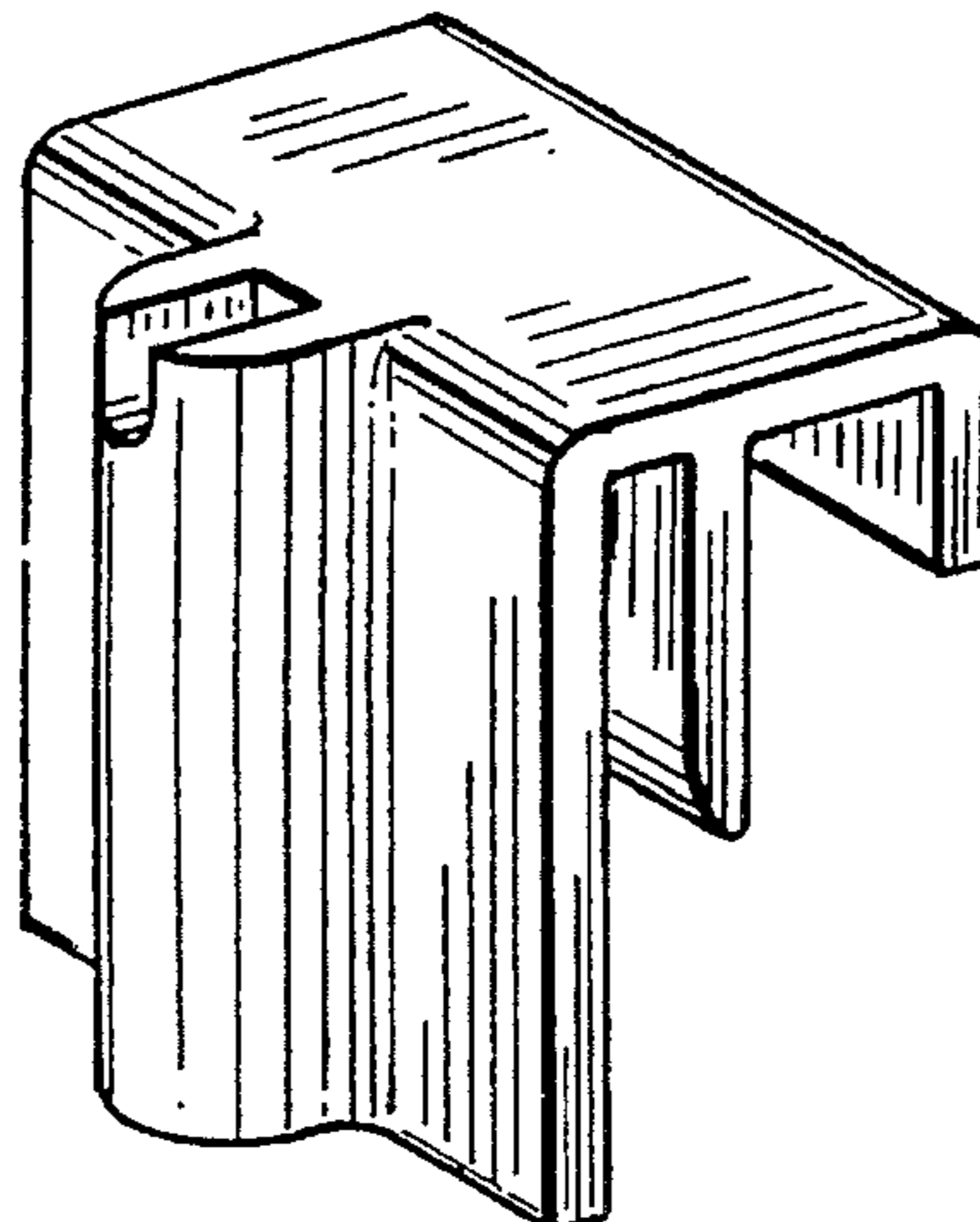
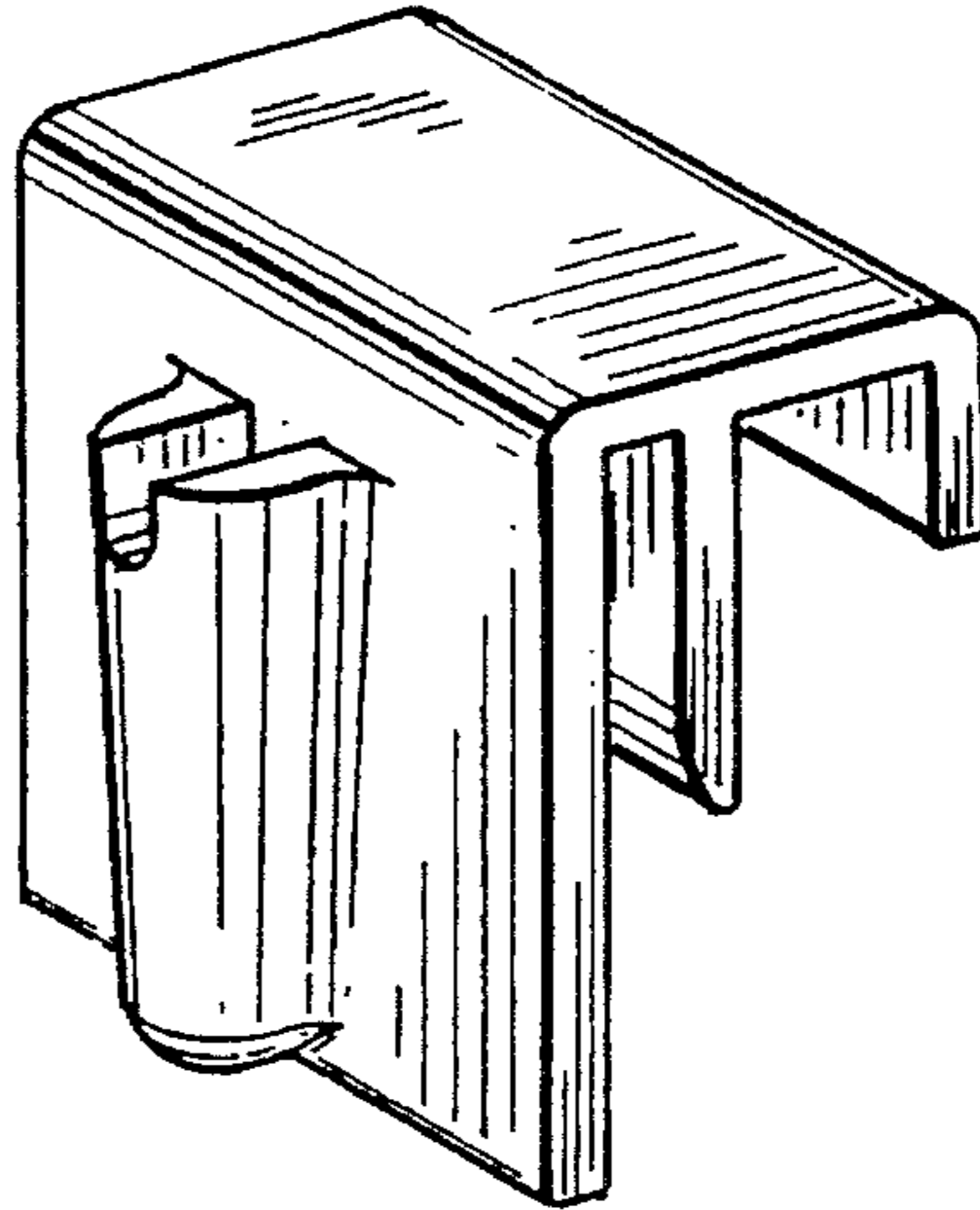

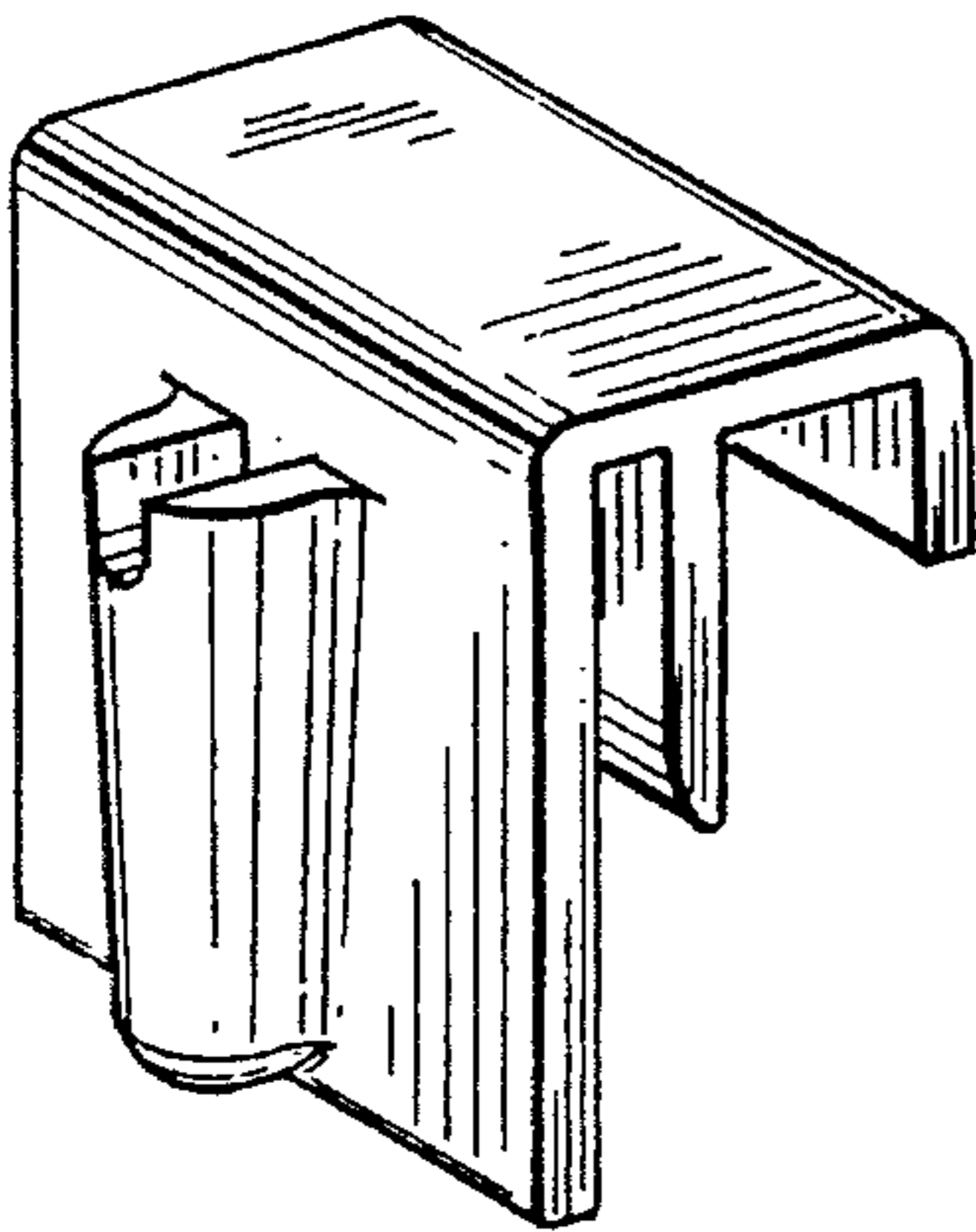

FIG. 1

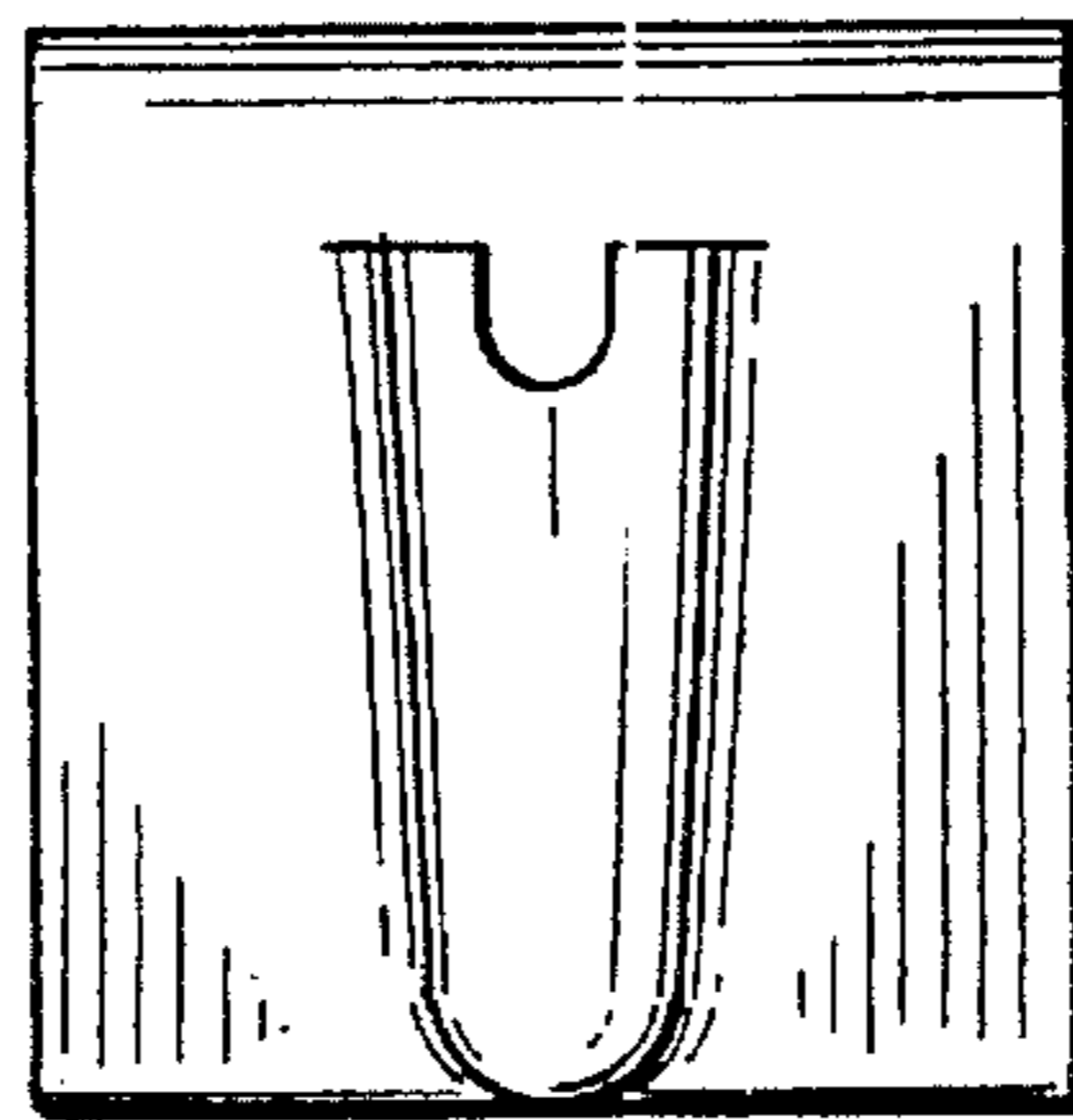

FIG. 2

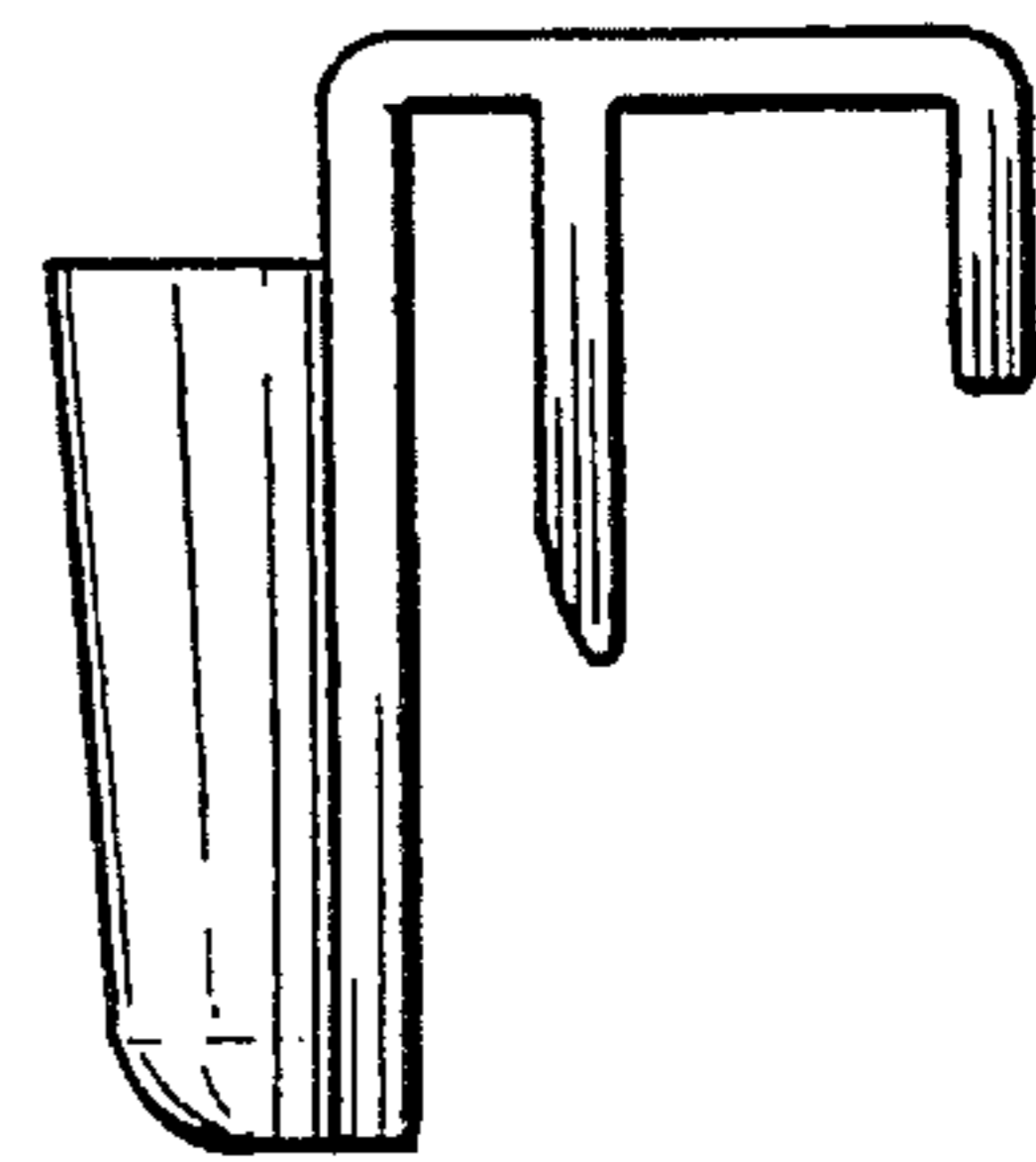

FIG. 3

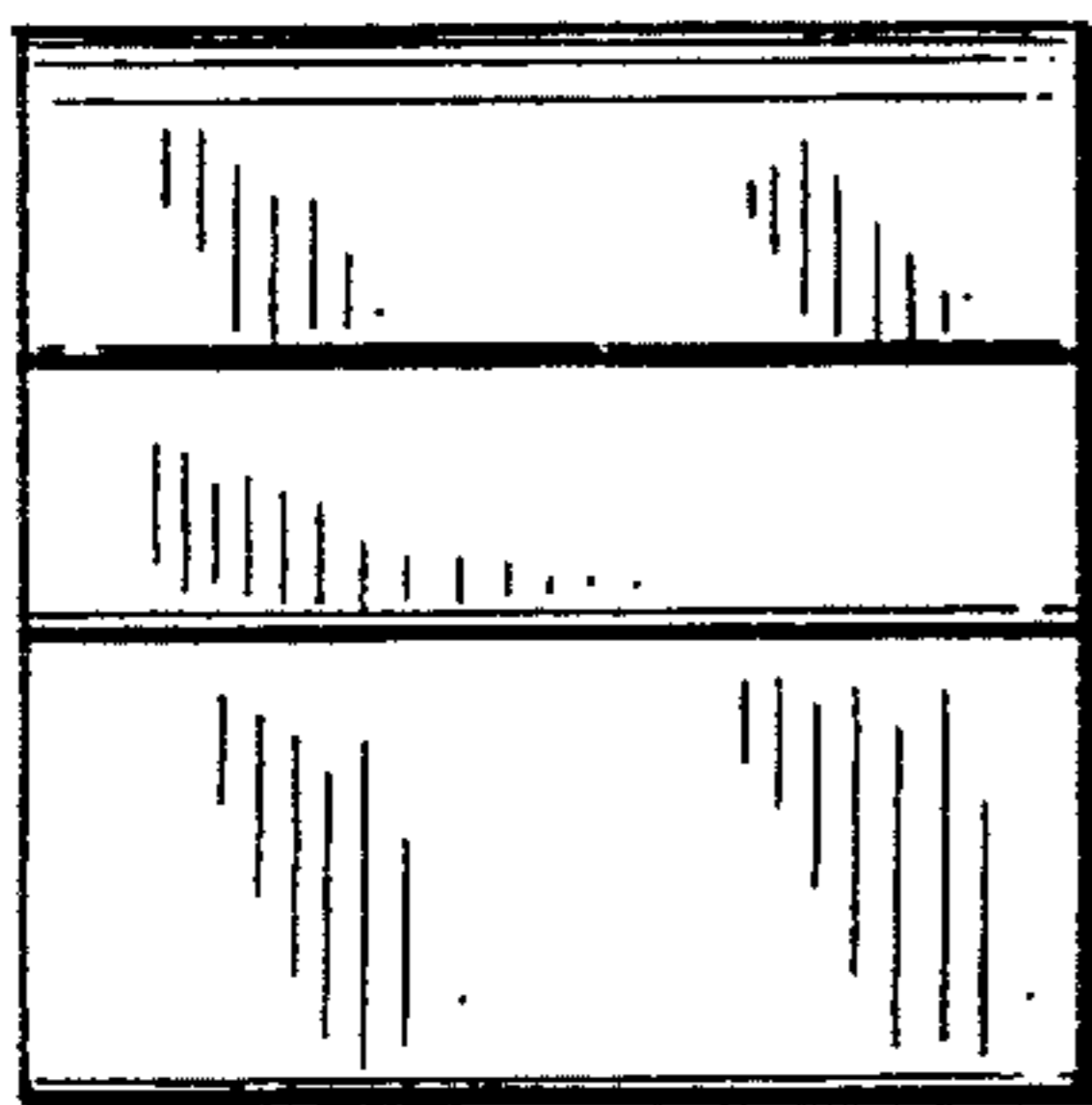

FIG. 4

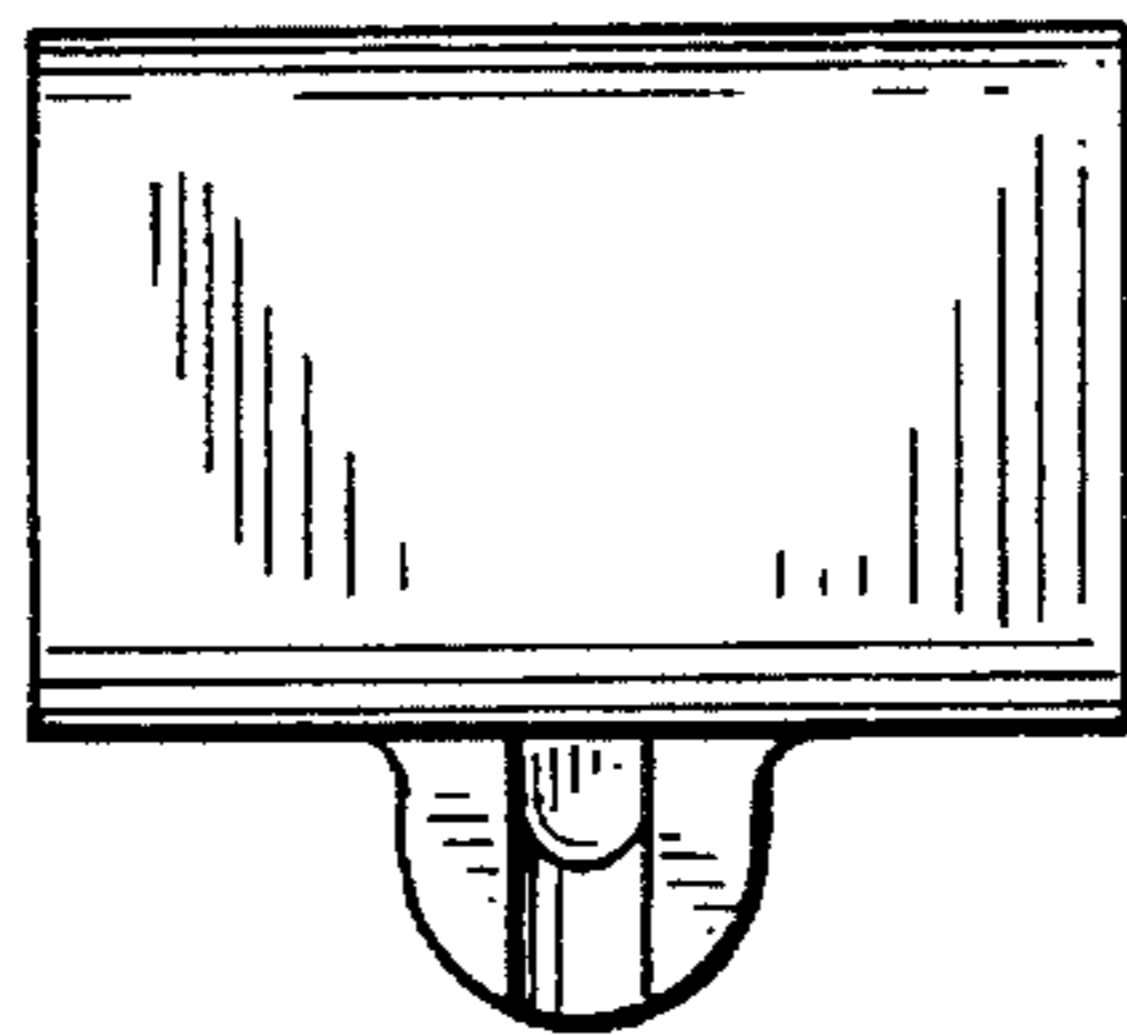

FIG. 5

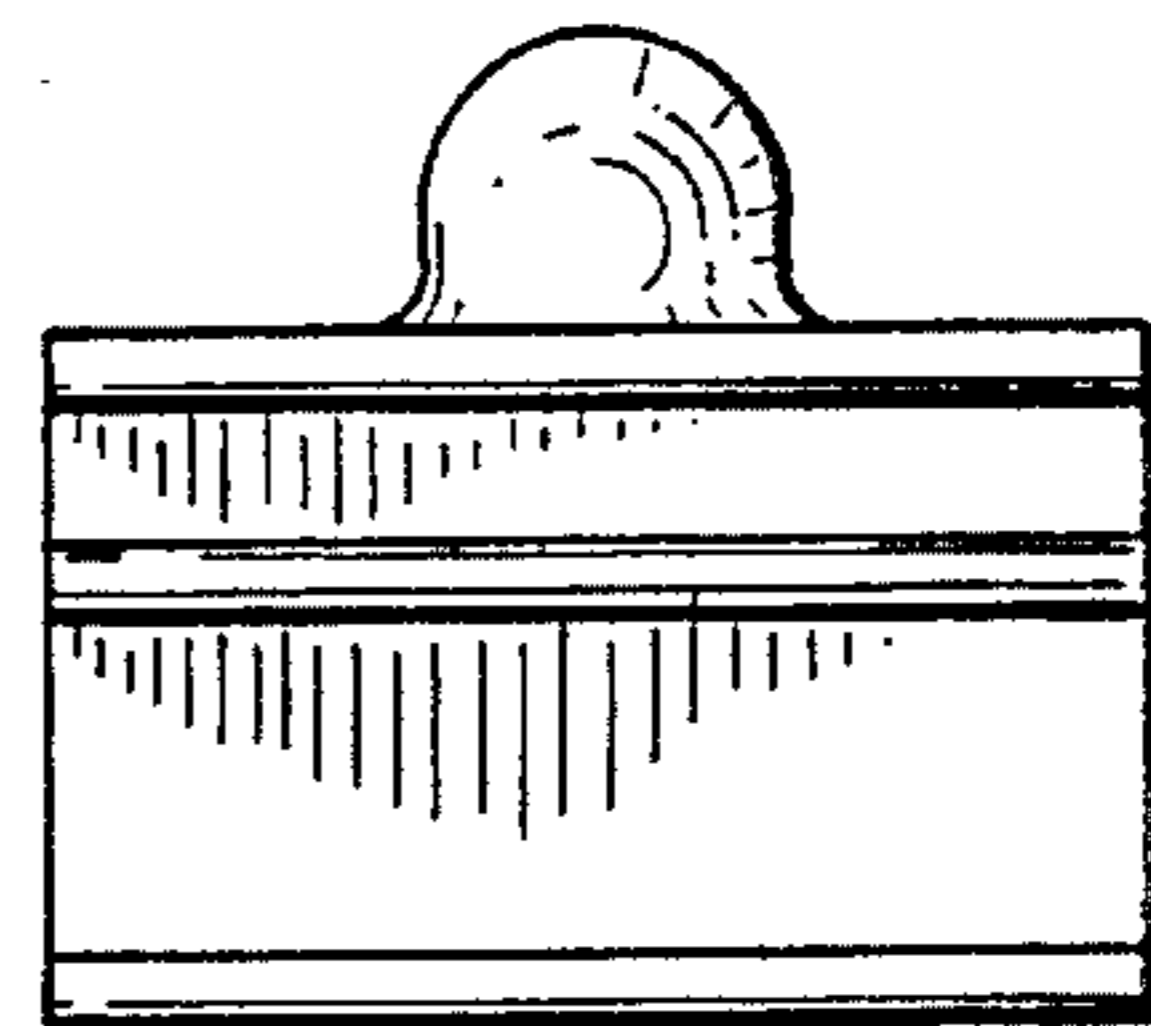

FIG. 6

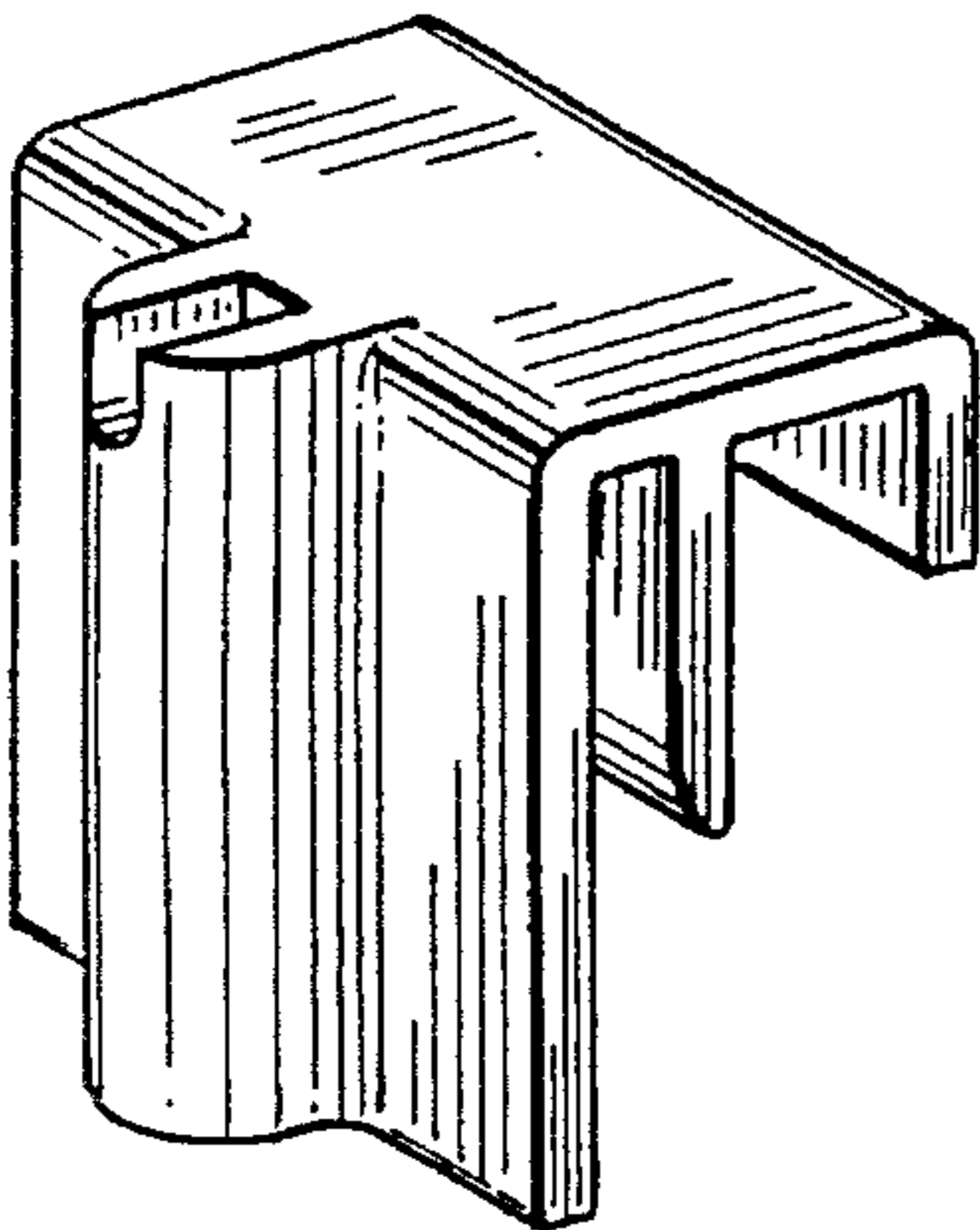

FIG. 7

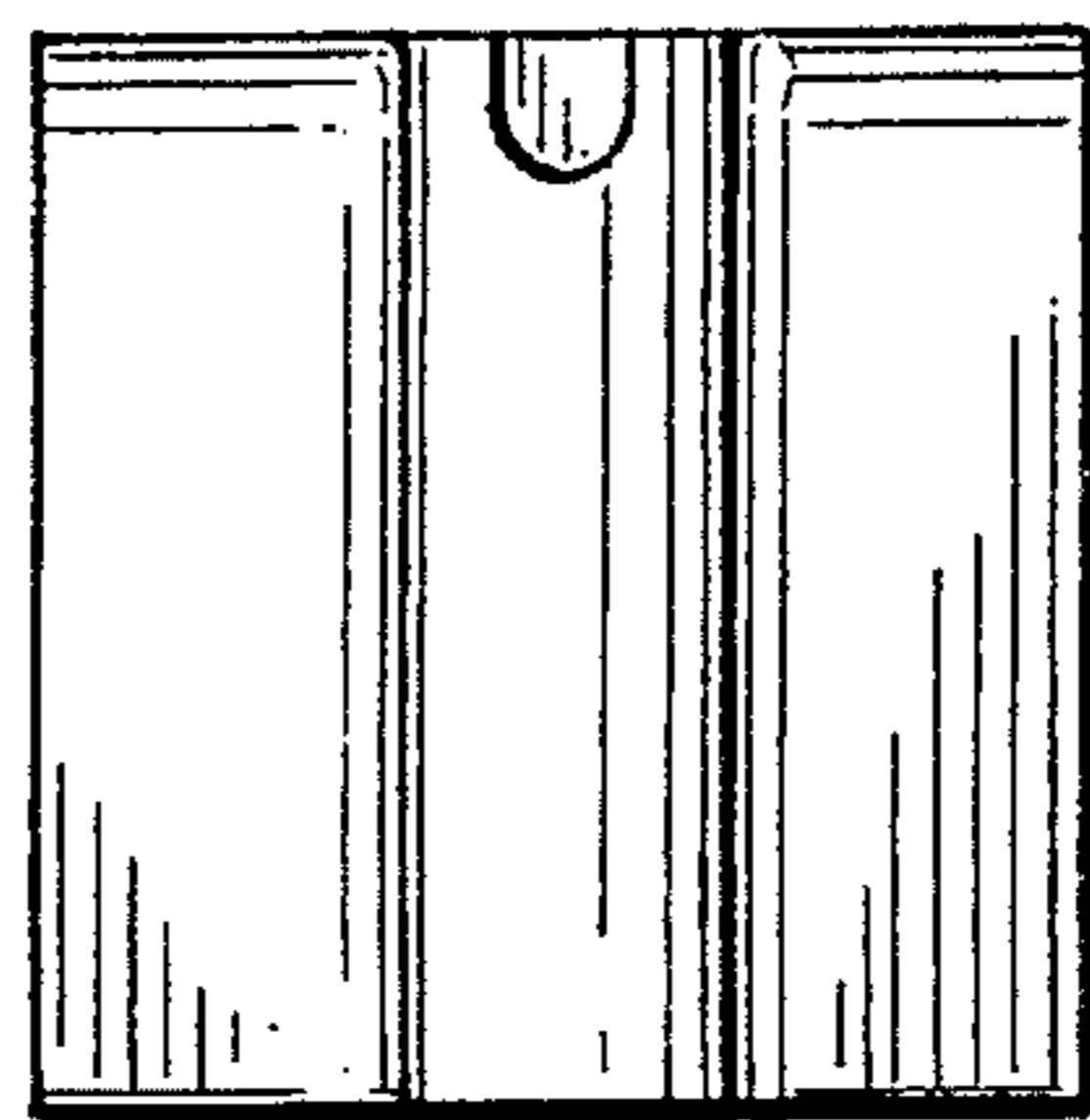

FIG. 8

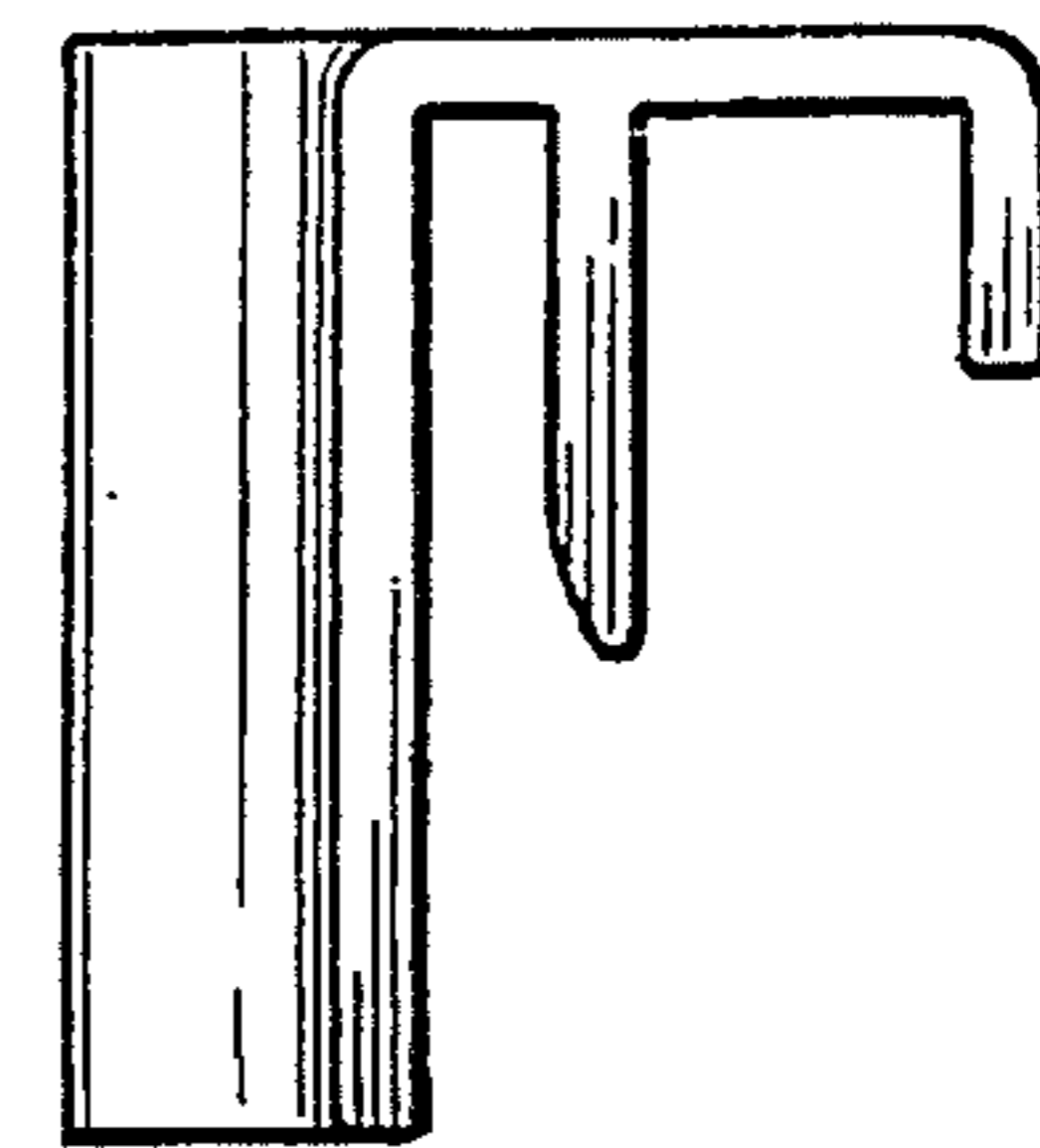

FIG. 9

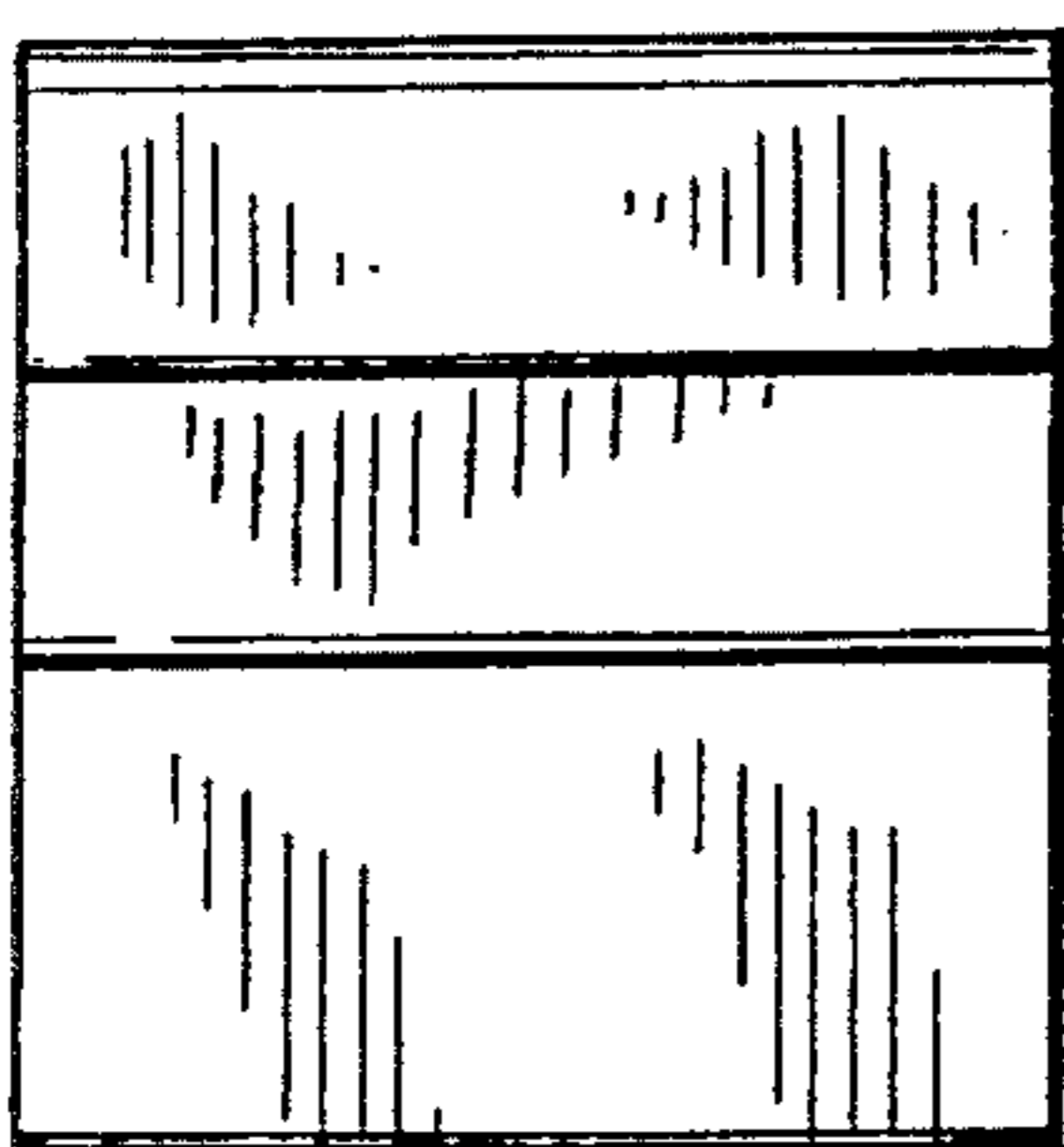

FIG. 10

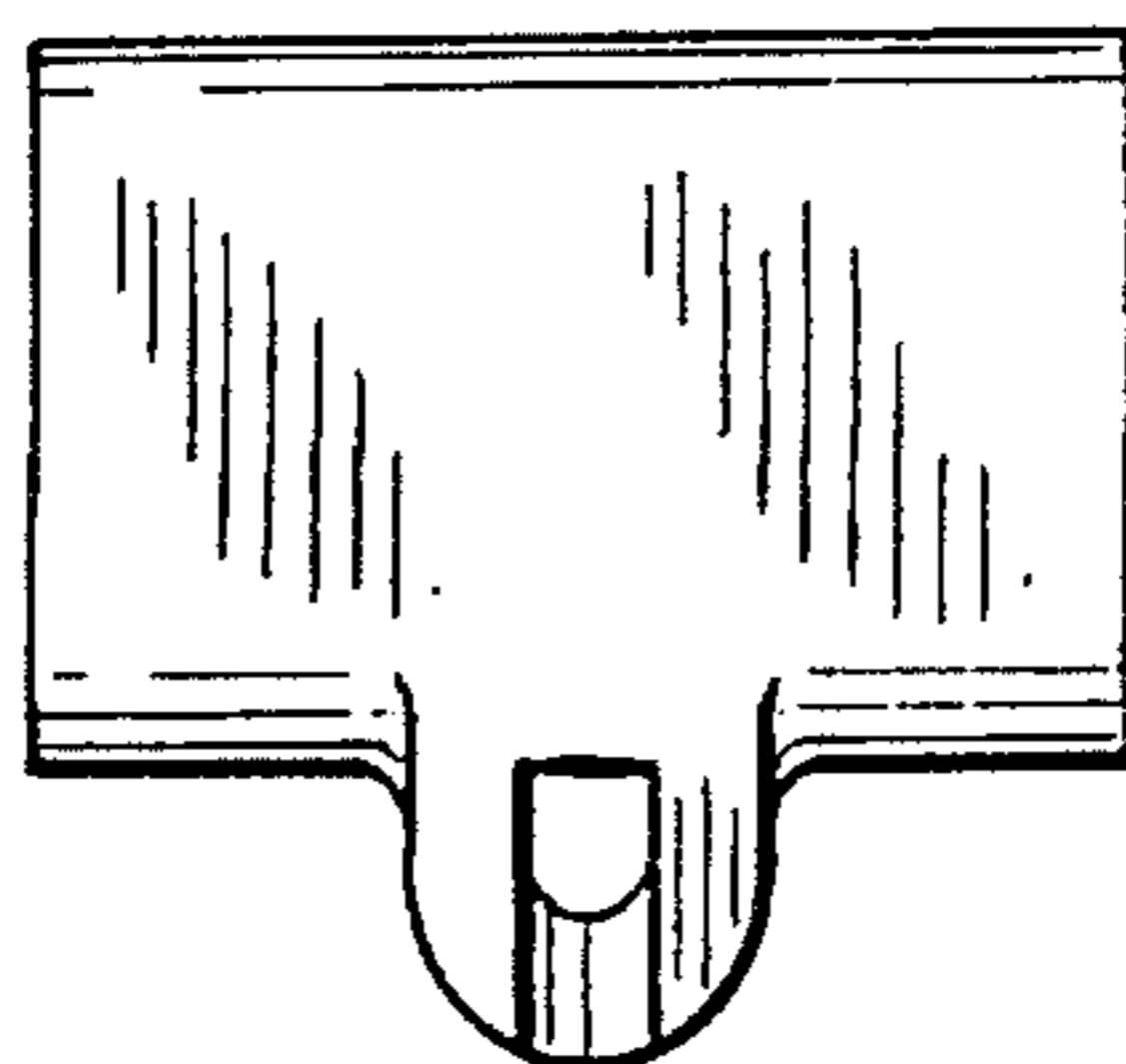

FIG. 11

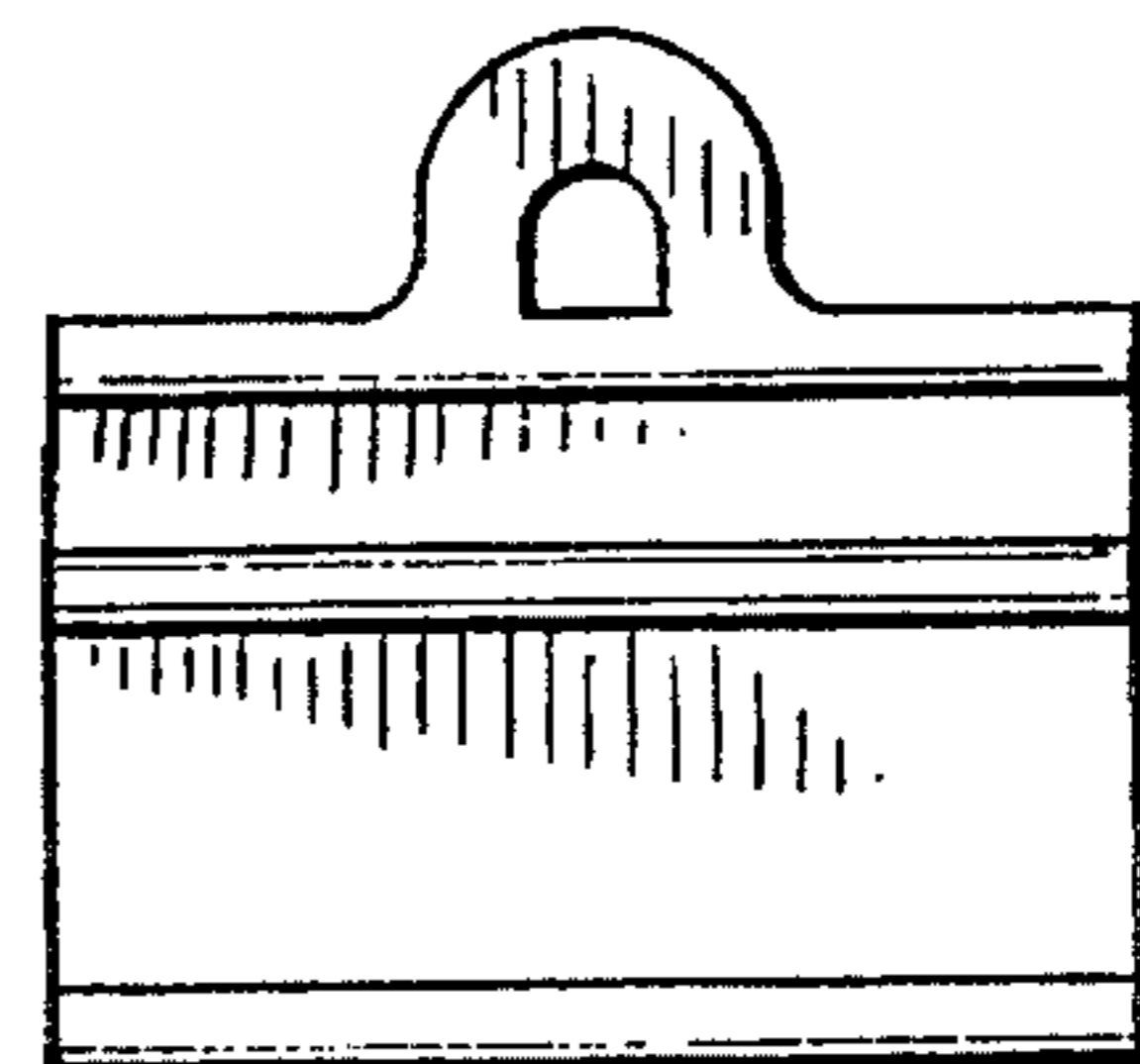

FIG. 12