



US00D366179S

United States Patent [19]

Hauser, II et al.

[11] Patent Number: Des. 366,179

[45] Date of Patent: **Jan. 16, 1996

[54] BEVERAGE DISPENSING CABINET

[75] Inventors: **Jon W. Hauser, II**, Geneva; **Ronald C. Katz**, Hinsdale, both of Ill.

[73] Assignee: **Elkay Manufacturing Company**, Oak Brook, Ill.

[**] Term: **14 Years**

[21] Appl. No.: **19,300**

[22] Filed: **Feb. 28, 1994**

[52] U.S. Cl. **D7/307; D7/308**

[58] Field of Search **D7/300, 304, 305, D7/306, 313, 307, 311; 222/183, 185; 62/395**

[56] **References Cited**

U.S. PATENT DOCUMENTS

D. 114,689	5/1939	Self	D7/306
D. 171,528	2/1954	Canter	D7/306
D. 172,708	7/1954	Freitag et al.	D7/306
D. 228,684	10/1973	Cannon et al.	D7/306
D. 308,794	6/1990	Larson	D7/306 X
D. 313,330	1/1991	Brusa	D7/307
D. 317,544	6/1991	Birmingham	D7/307
D. 350,453	9/1994	Chaney	D7/306
4,881,380	11/1989	Mrugala et al.	62/389
4,892,207	1/1990	Cullis	D7/306 X
5,356,046	10/1994	Burke	222/185 X

OTHER PUBLICATIONS

Pure & Simple Water Cooler, N.Y. Times Nov. 4, 1987.
 Promotional literature, Elkay Manufacturing Company, undated but prior art to present application.
 Promotional literature, new product announcement, Elkay Manufacturing Company, May 1990.
 Promotional literature, new product announcement, Elkay Manufacturing Company, Sep. 1989.
 Promotional literature, new product, Elkay Manufacturing Company, Jul. 1988.
 Promotional literature, "Temprite," Elkay Manufacturing Company, Oct. 1984.
 Promotional literature, "Easy Handler," Elkay Manufacturing Company, Apr. 1992, p. 1.
 Promotional literature, "Deluxe," Elkay Manufacturing

Company, Mar. 1990, p. 1.
 Promotional literature "Keeps Chilling," Elkay Manufacturing Company, 1992, Figures on pp. 1 and 2.
 Promotional literature, Elkay Manufacturing Company, Mar. 1990, Figures on pp. 1 and 2.
 Promotional literature, new product announcement, Elkay Manufacturing Company, Dec. 1989, Figures on p. 1.
 Promotional literature, "No-Spill Water Safe System," Elkay Manufacturing Company, Aug. 1991, Figures on p. 1.
 Promotional literature, "The New Water Bar," Elkay Manufacturing Company, Jun. 1989, Figures on pp. 1 and 2.
 Promotional literature, "Easy Handler," Elkay Manufacturing Company, Oct. 1991, Figures on p. 1.
 Promotional literature, "Water Sentry," Elkay Manufacturing Company, Nov. 1988, Figures on pp. 1 and 2.

(List continued on next page.)

Primary Examiner—Antoine Duval Davis
Assistant Examiner—M. N. Pandozzi
Attorney, Agent, or Firm—Leydig, Voit & Mayer, Ltd.

[57] **CLAIM**

The ornamental design for a beverage dispensing cabinet, as shown and described.

DESCRIPTION

FIG. 1 is a top, front, left perspective view of a beverage dispensing cabinet showing our new design;
 FIG. 2 is a perspective taken from the top, front and right side thereof;
 FIG. 3 is a top, front, and right perspective view thereof;
 FIG. 4 is a left side view thereof;
 FIG. 5 is a right side view thereof;
 FIG. 6 is a rear view thereof;
 FIG. 7 is a top plan view thereof;
 FIG. 8 is a top, front, left perspective view of a beverage dispensing cabinet showing a second embodiment of our new design;
 FIG. 9 is a bottom plan view of both embodiments thereof.
 The side elevational views and rear elevational view of the second embodiment are identical to that of the first embodiment, the only difference being the lack of a protruding circular portion along the top.

1 Claim, 3 Drawing Sheets

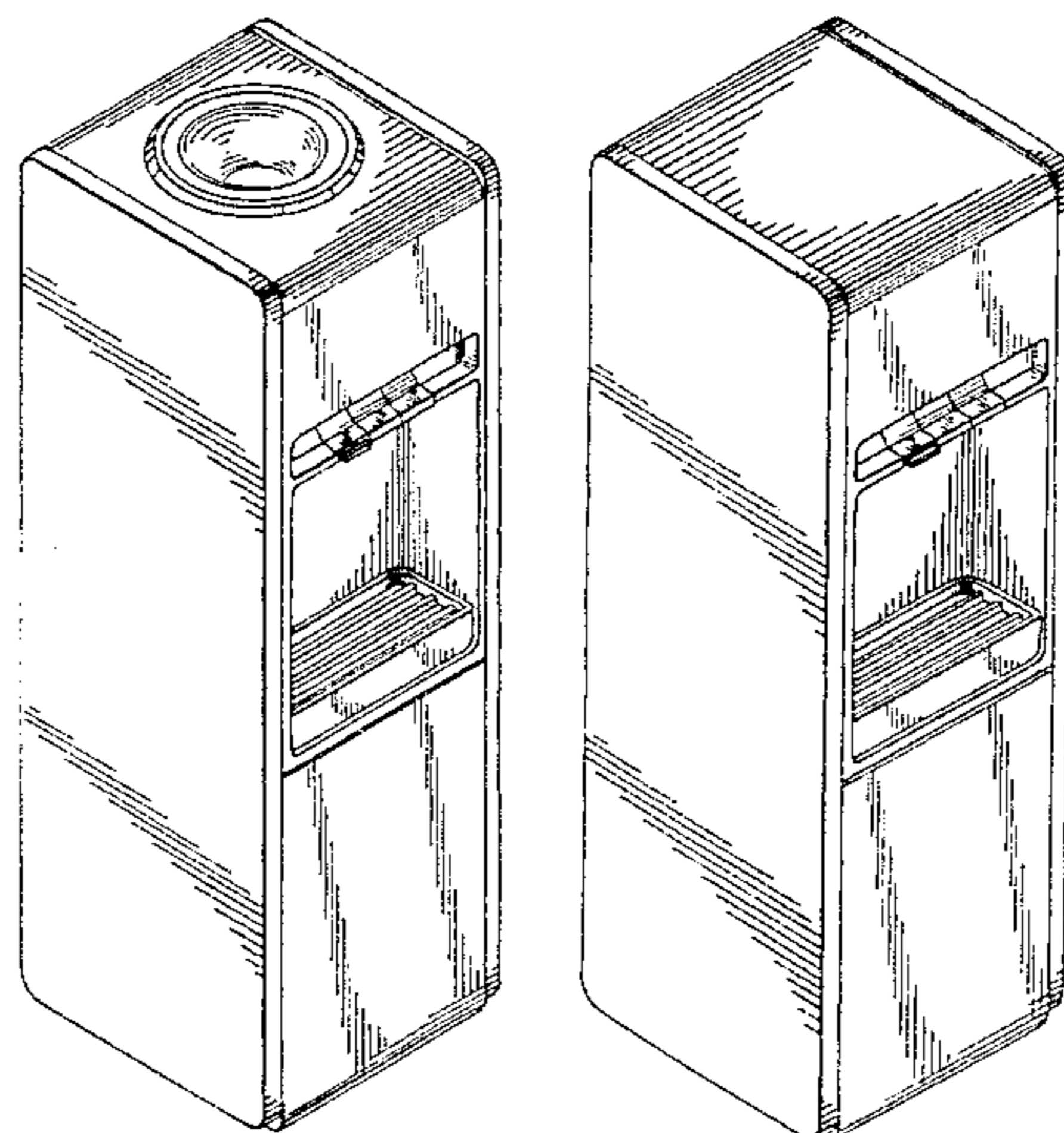

OTHER PUBLICATIONS

Promotional literature, "Easy Handler," Elkay Manufacturing Company, Nov. 1988, Figures on pp. 1 and 2.

Promotional literature, Elkay Manufacturing Company, Jun. 1991, Figures on pp. 1 and 2.

Promotional literature, "Water Sentry Filters," Elkay Manu-

facturing Company, Jul. 1993, Figures centered on p. 1.

Promotional literature, "Refreshment Center," Elkay Manufacturing Company, 1992, Figures on pp. 1 and 2.

Promotional literature, new product introduction, Elkay Manufacturing Company, Mar. 1991, Figures on pp. 1, 2 and 3.

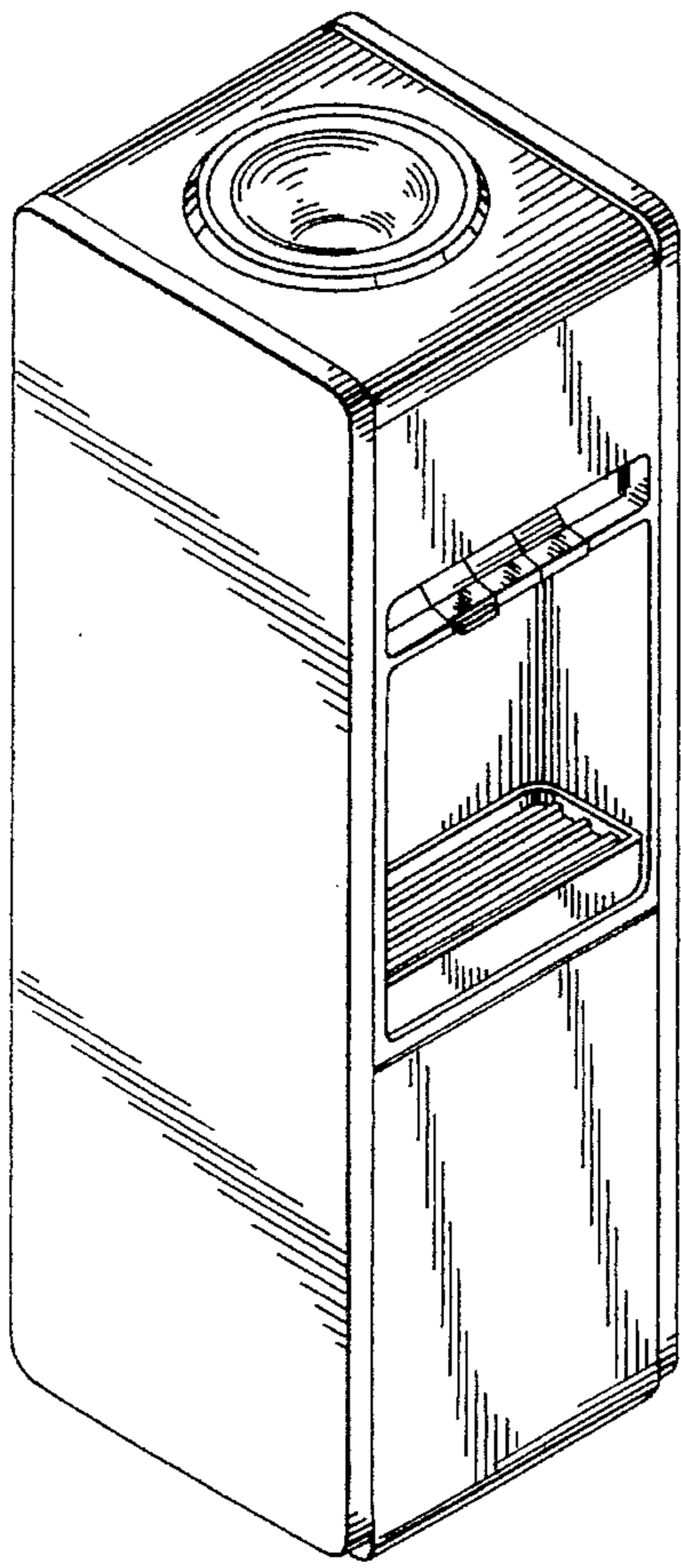

FIG. 1

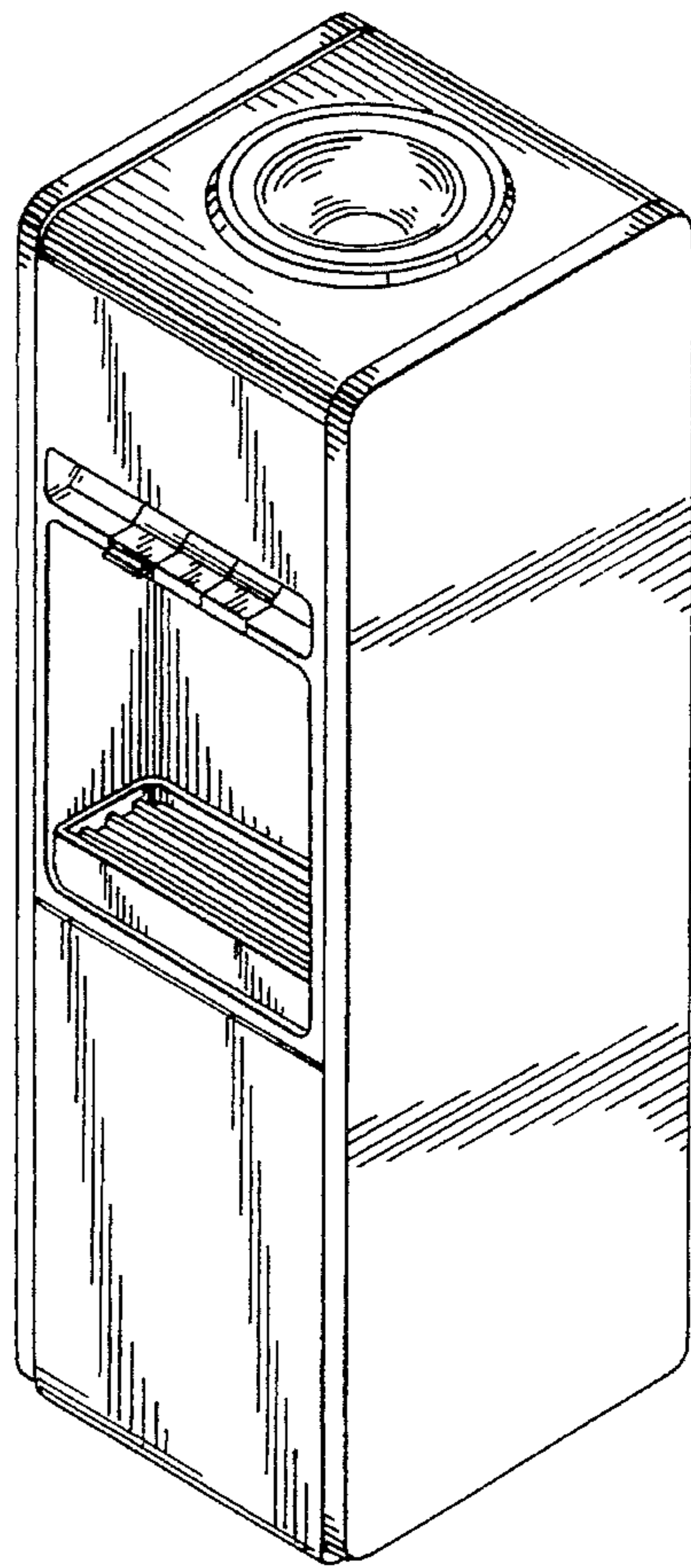

FIG. 2

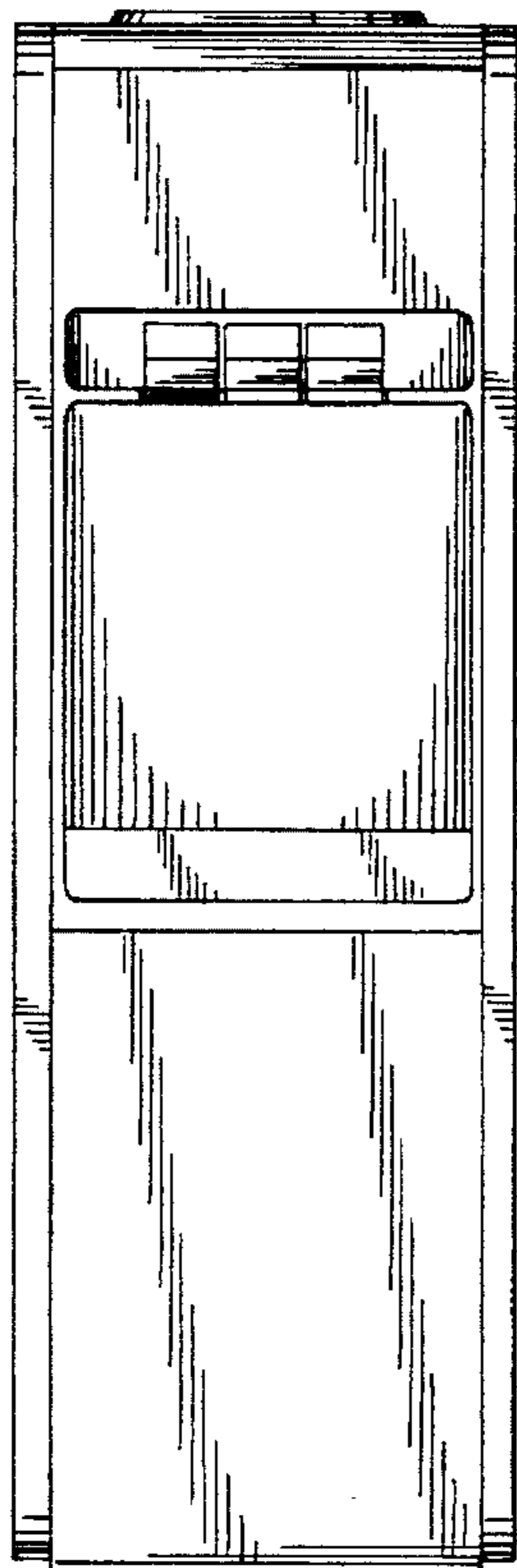

FIG. 3

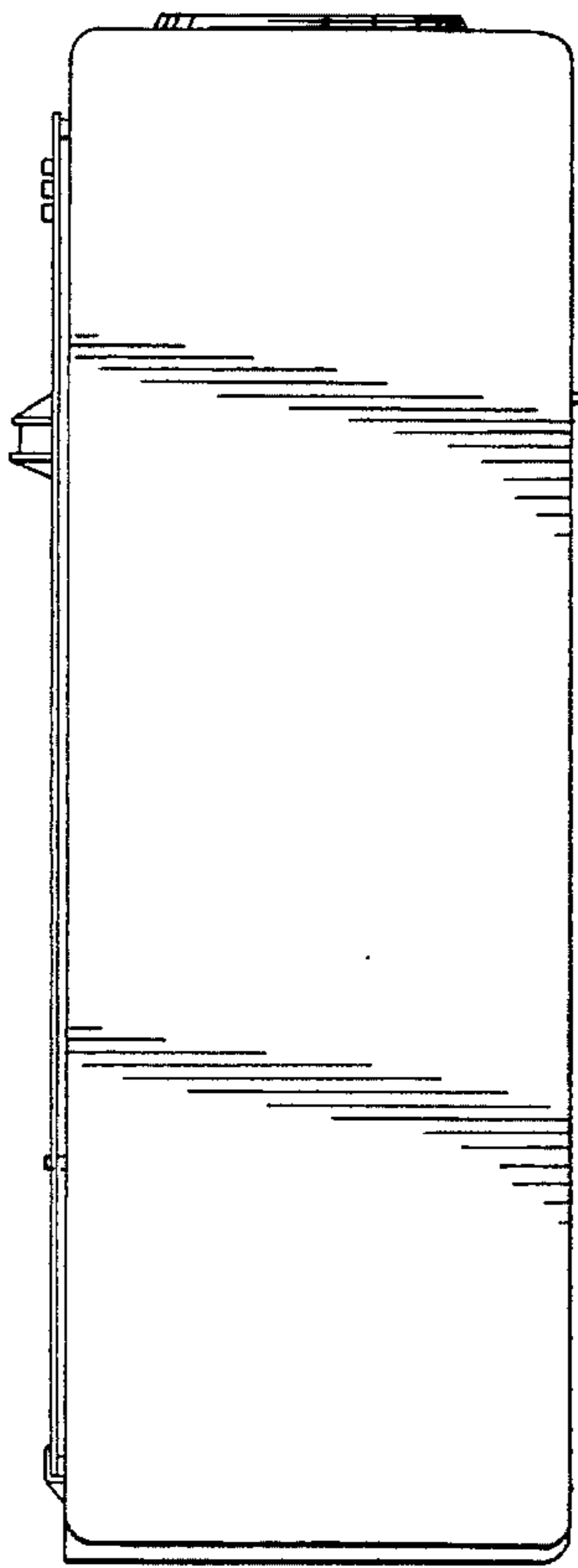

FIG. 4

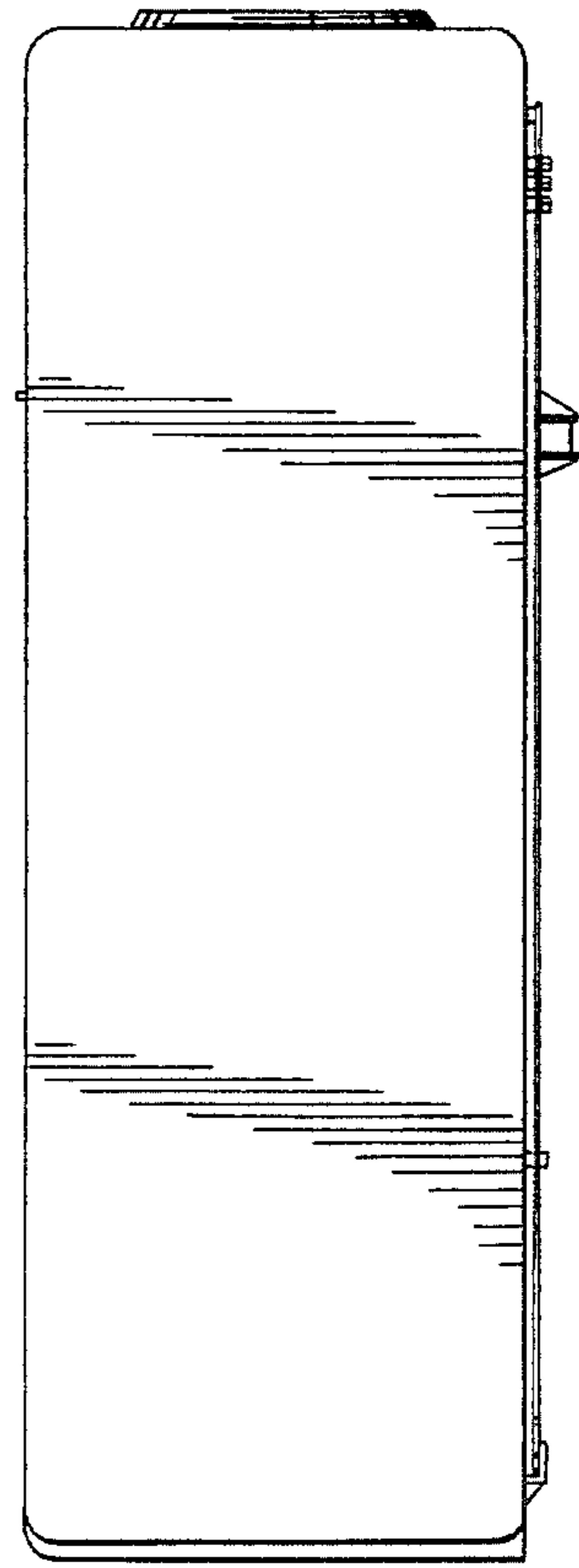

FIG. 5

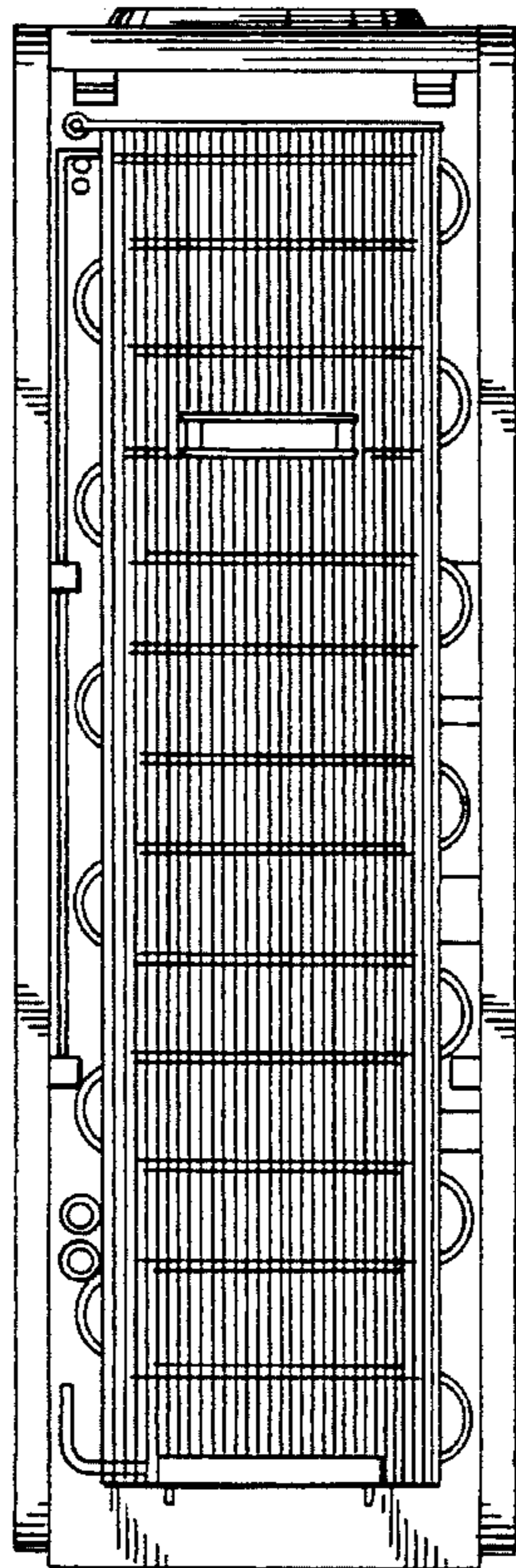

FIG. 6

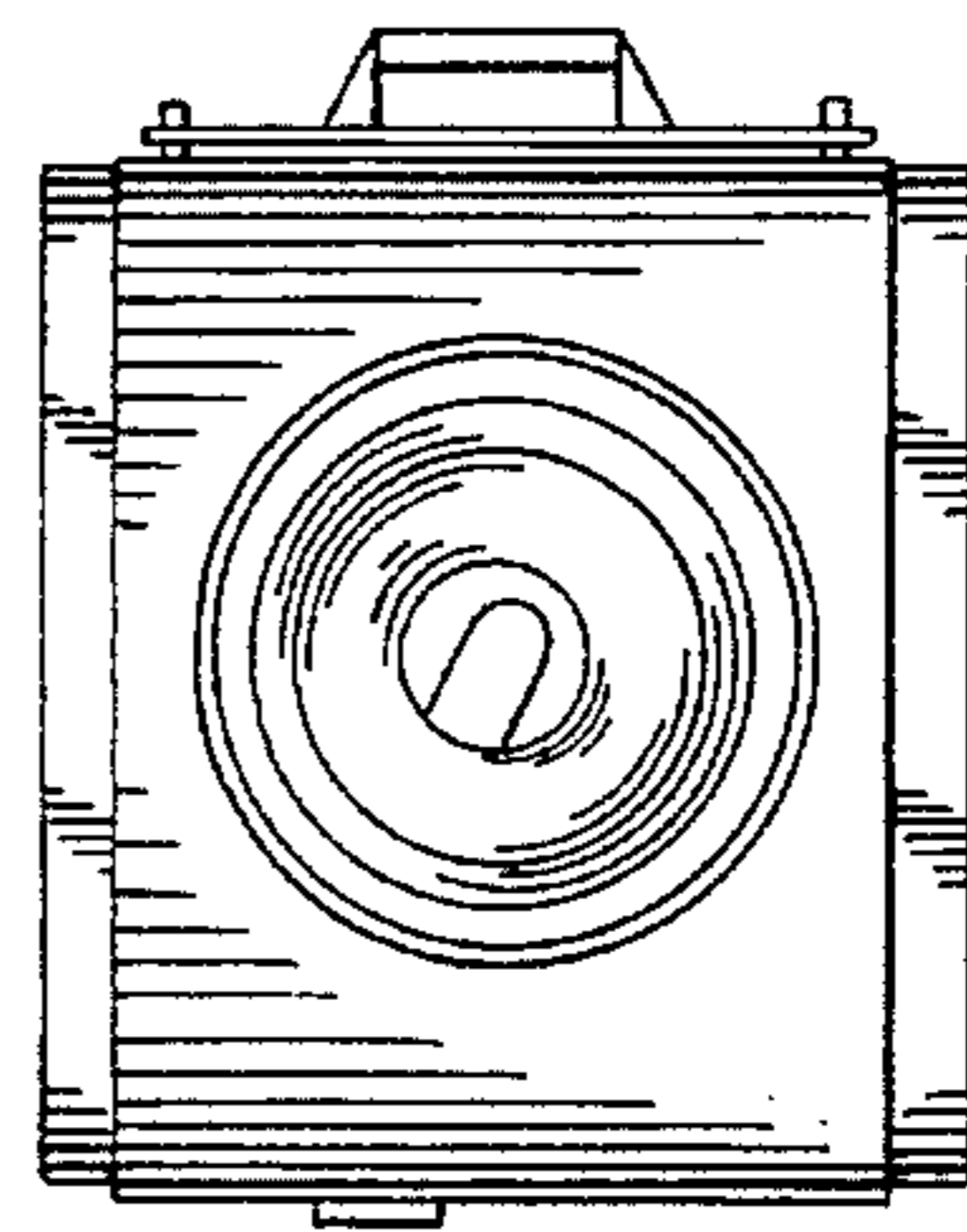

FIG. 7

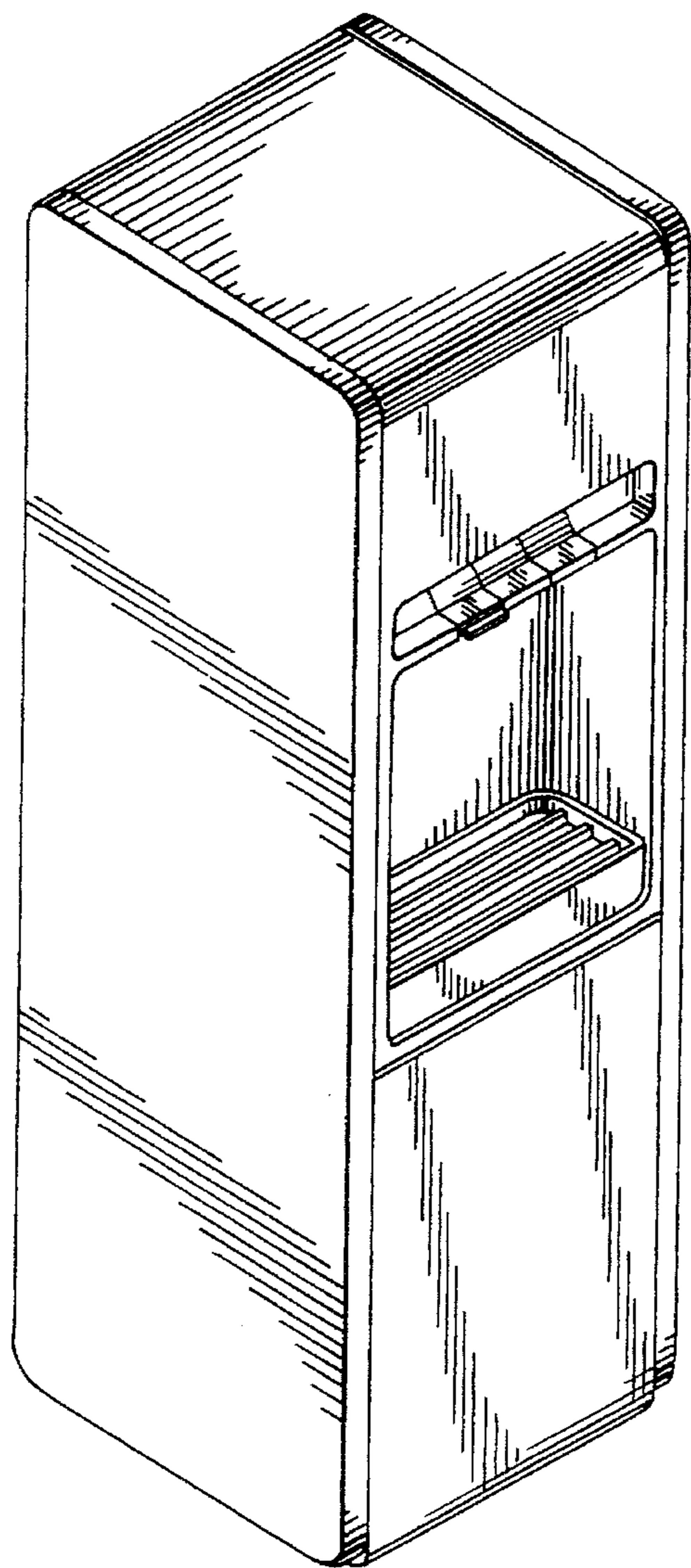

FIG. 8

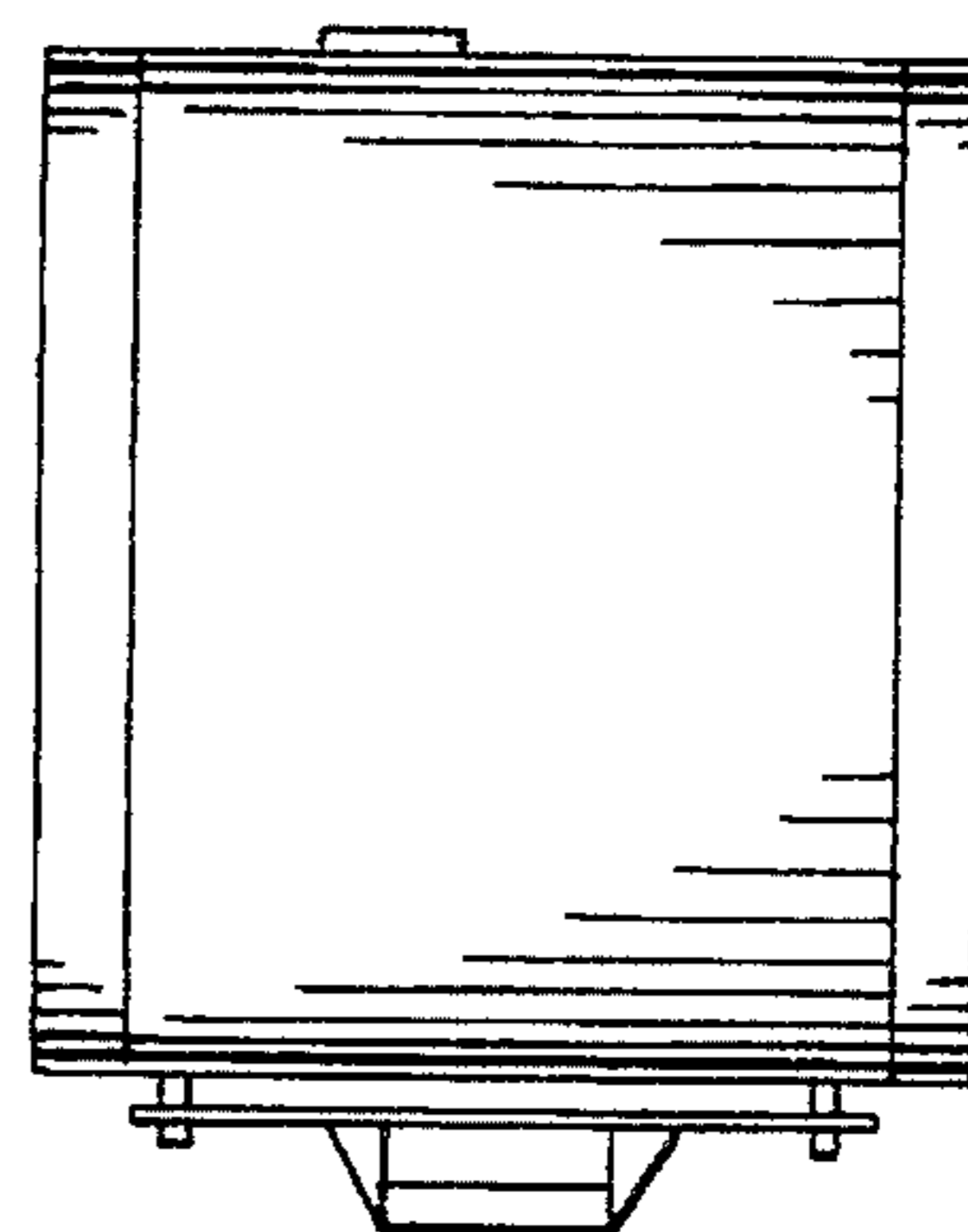

FIG. 9