



US00D366163S

United States Patent [19]
Ribeiro

[11] **Patent Number: Des. 366,163**

[45] **Date of Patent: **Jan. 16, 1996**

[54] **PLANT STAND**

[76] Inventor: **Claudio S. Ribeiro**, 458 - 6th St.,
Garden Apartment, Brooklyn, N.Y.
11215

[**] Term: **14 Years**

[21] Appl. No.: **34,200**

[22] Filed: **Jan. 30, 1995**

[52] U.S. Cl. **D6/403**

[58] Field of Search D6/403, 405, 477-479,
D6/455, 461, 462, 396, 479

[56] **References Cited**

U.S. PATENT DOCUMENTS

D. 278,549 4/1985 Kristich D6/347 X
D. 300,886 5/1989 Johnson, Jr. D6/403

OTHER PUBLICATIONS

“Pottery Barn” Catalog, Jan. 1992, p. 4, item C, Madera
Plant Stands, Plant Husbandry Stands.

Primary Examiner—Alan P. Douglas

Assistant Examiner—Cathron B. Matta
Attorney, Agent, or Firm—Paul M. Craig, Jr.

[57] **CLAIM**

The ornamental design for a plant stand, as shown and
described.

DESCRIPTION

FIG. 1 is a perspective view of the plant stand showing my
new design;
FIG. 2 is a front elevational view thereof;
FIG. 3 is a front elevational view thereof taken at 45° of the
view in FIG. 2;
FIG. 4 is a top plan view thereof;
FIG. 5 is a bottom plan view thereof;
FIG. 6 is a perspective view of the plant stand with only
three legs;
FIG. 7 is a front elevational view thereof;
FIG. 8 is a front elevational view thereof taken at 45° of the
view in FIG. 7;
FIG. 9 is a top plan view thereof; and,
FIG. 10 is a bottom plan view thereof.

1 Claim, 4 Drawing Sheets

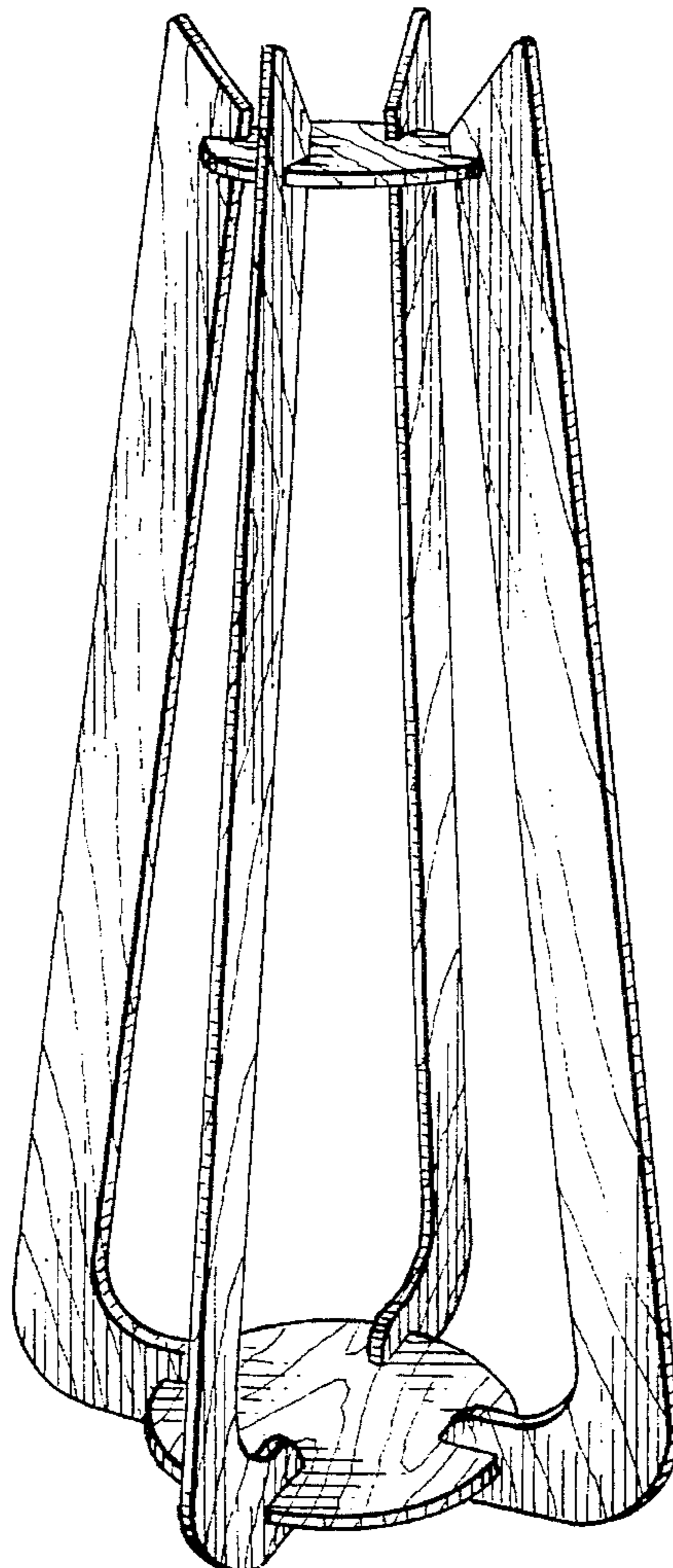

FIG. 1

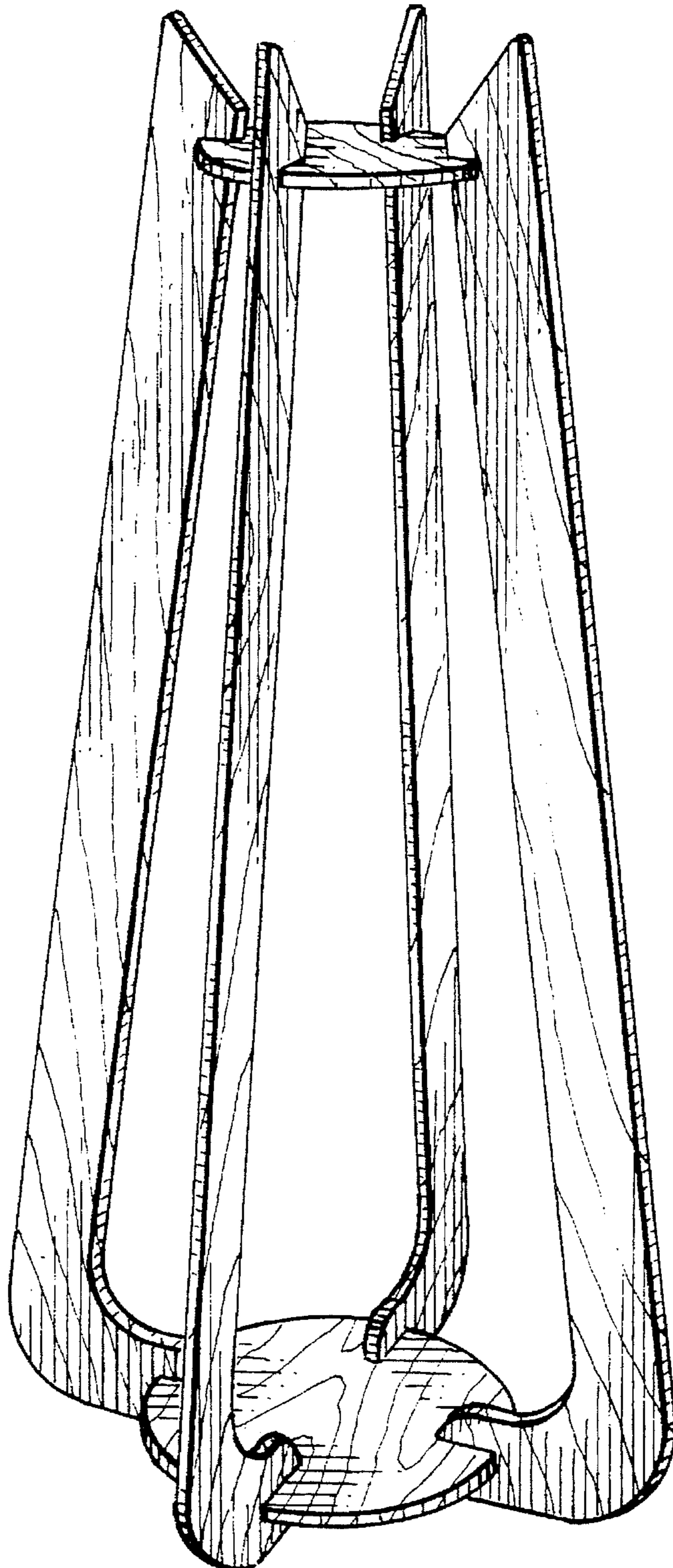

FIG. 2

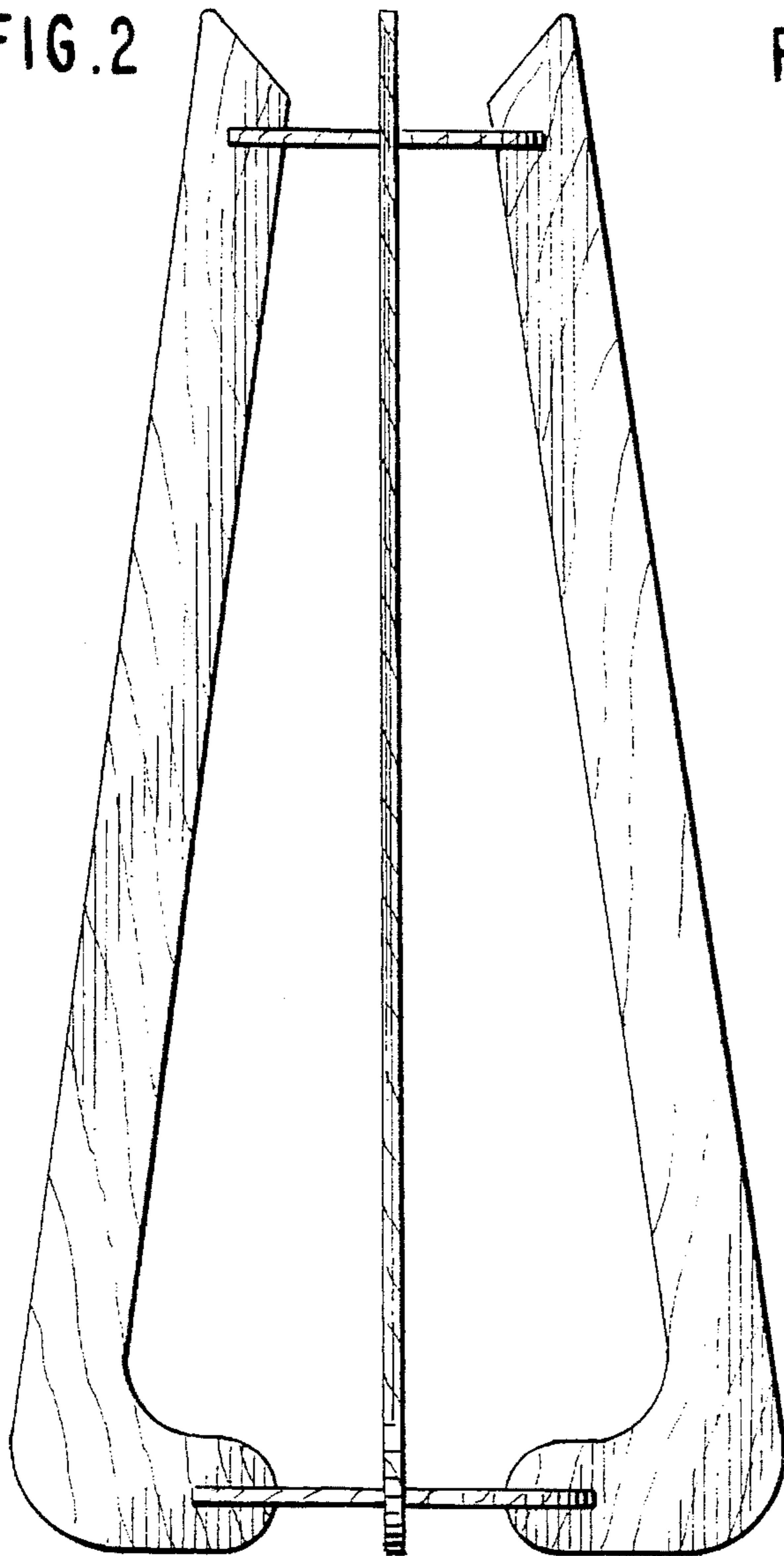

FIG. 3

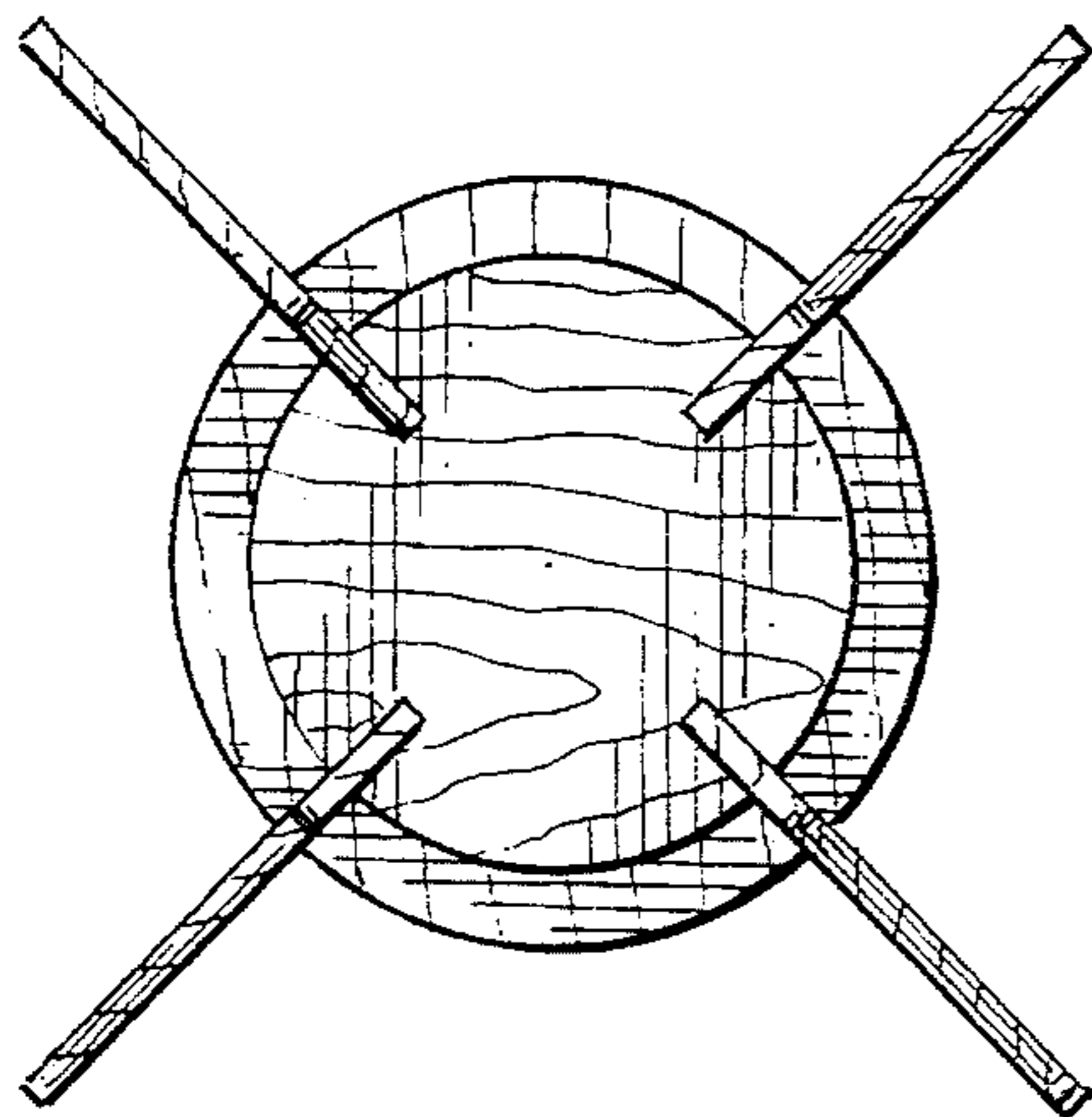
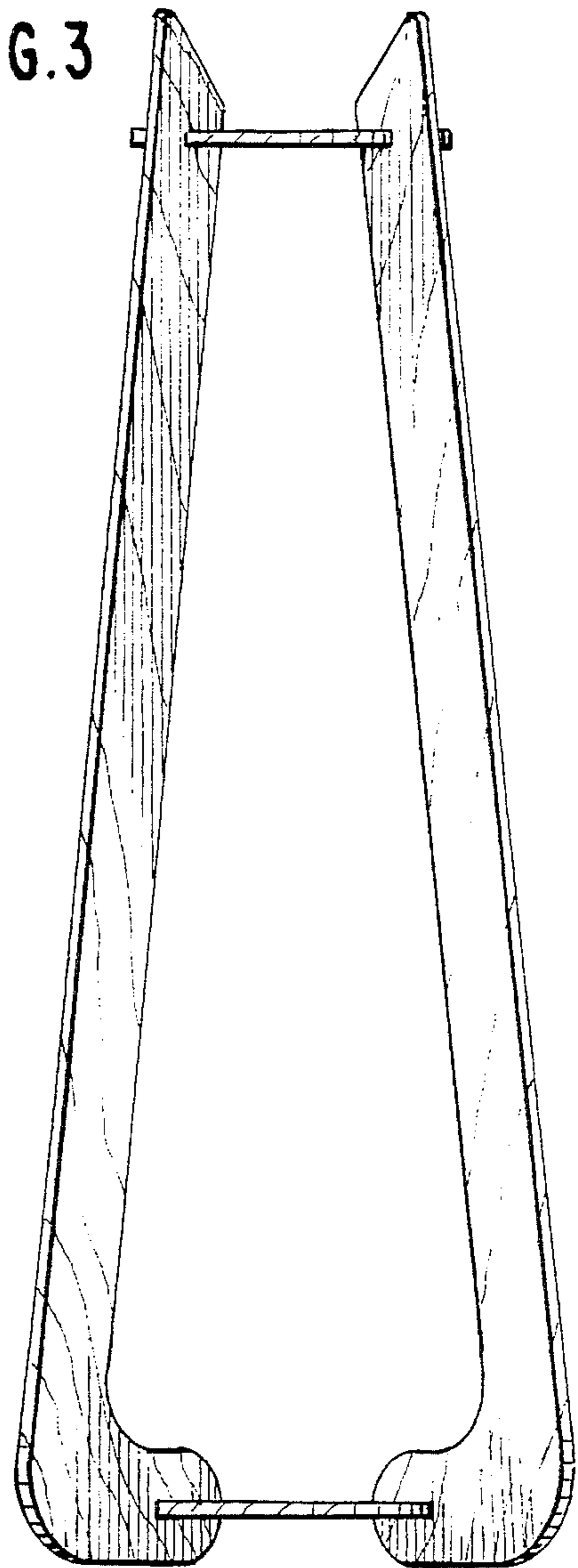

FIG. 4

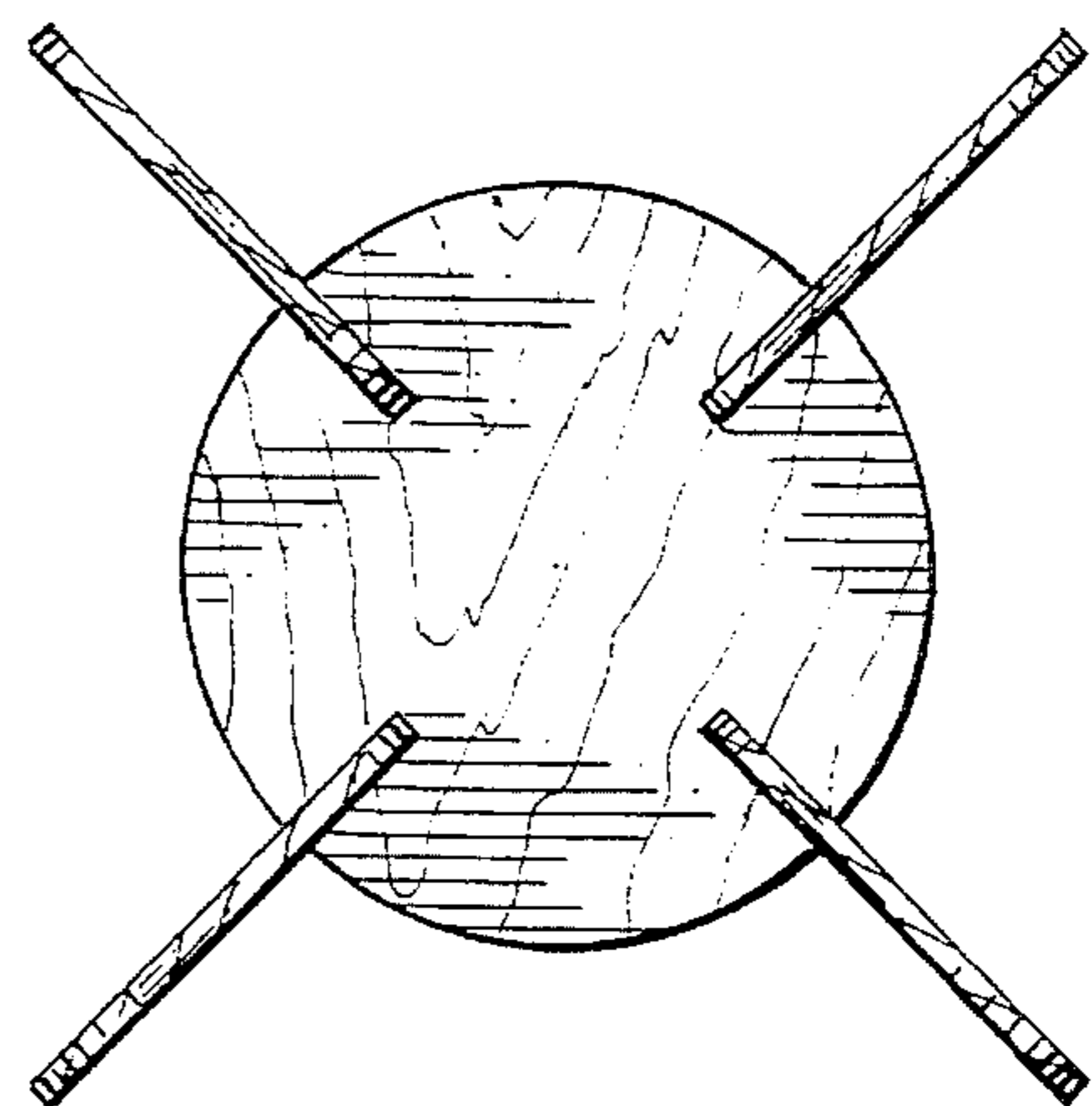

FIG. 5

FIG. 6

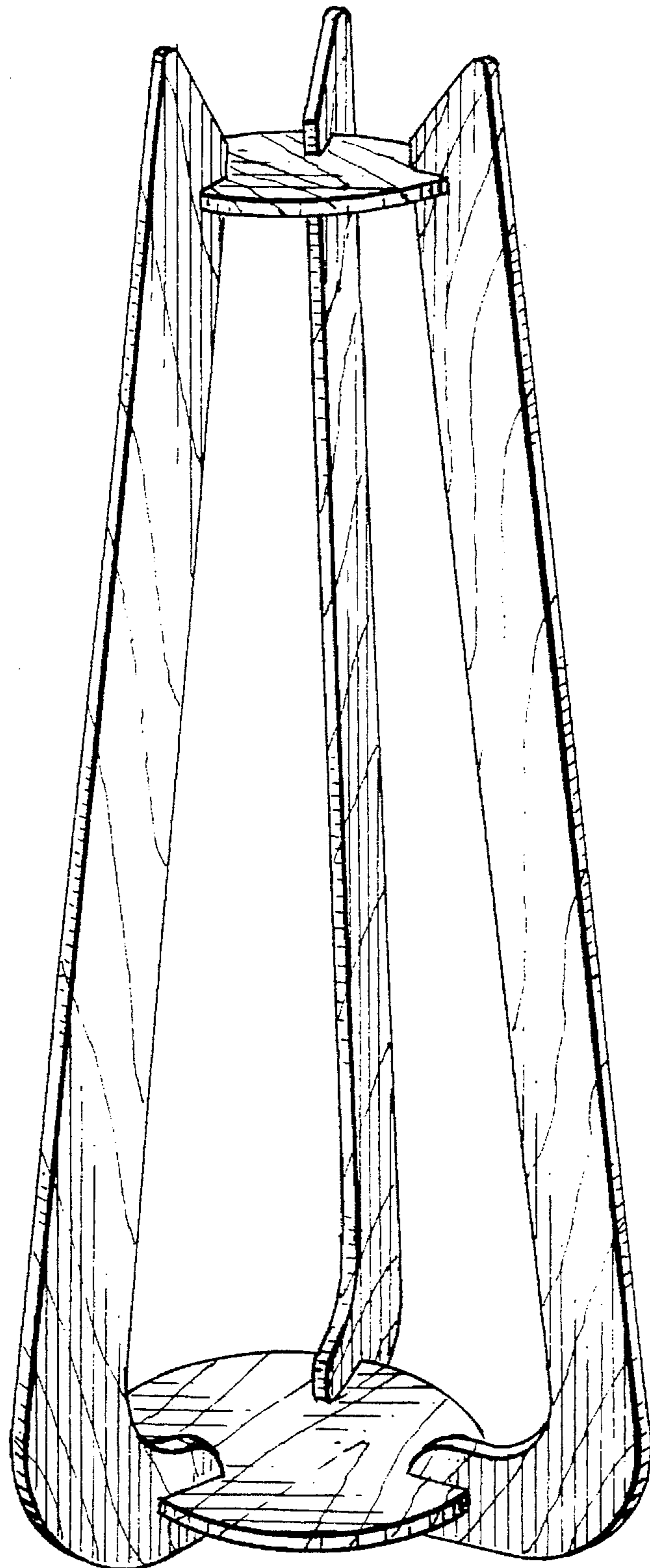

FIG. 7

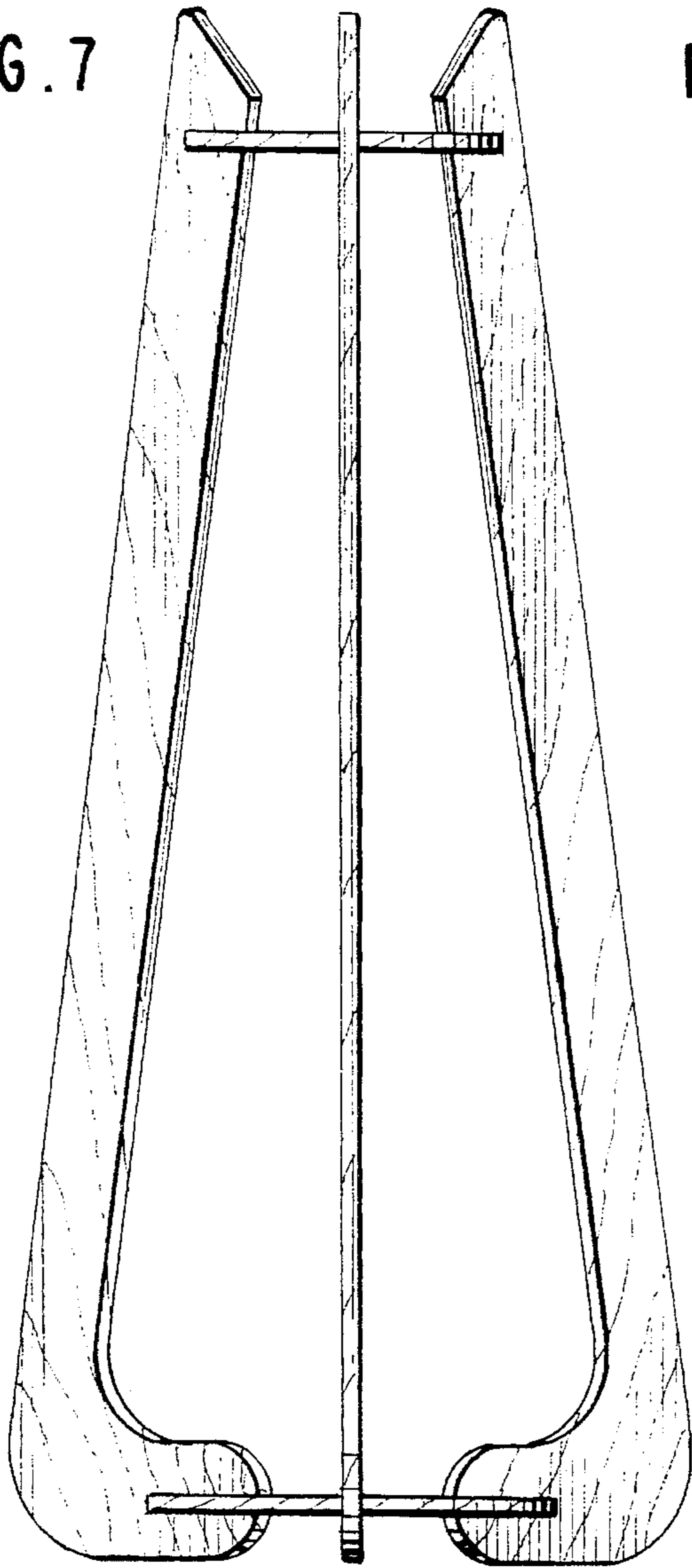

FIG. 8

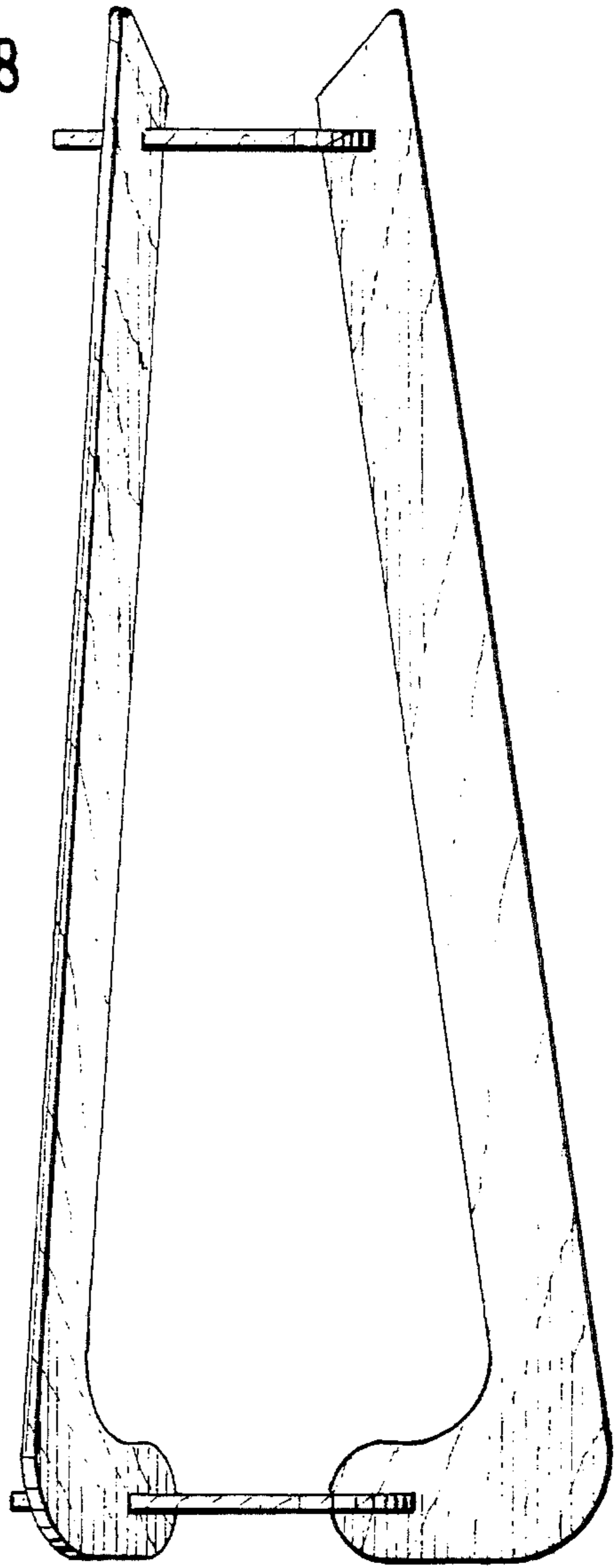

FIG. 9

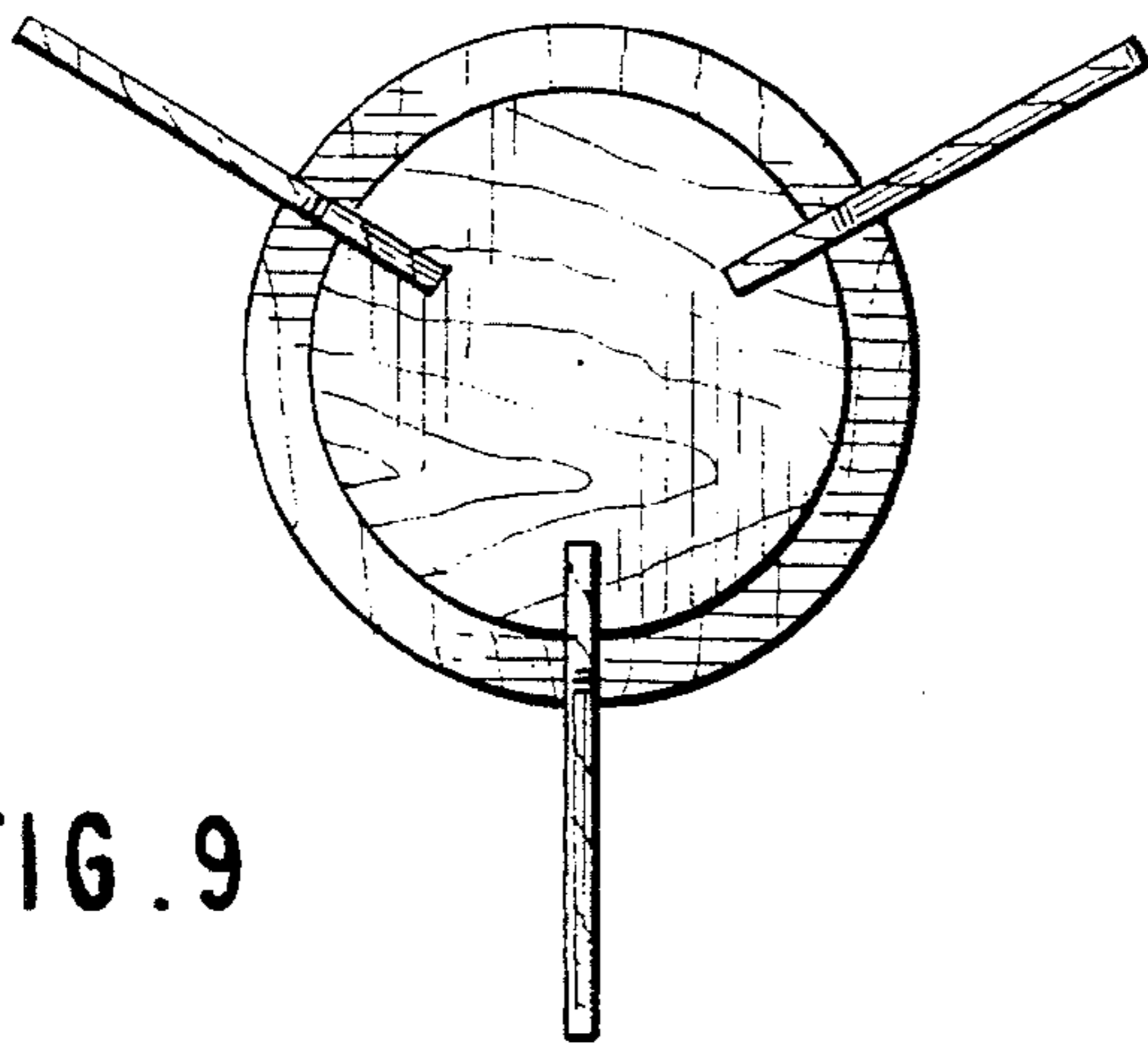

FIG. 10

