



US00D366158S

**United States Patent** [19]  
**Wirth**

[11] **Patent Number: Des. 366,158**  
[45] **Date of Patent: \*\*Jan. 16, 1996**

[54] **SEAT**

[75] Inventor: **Heinz Wirth**, Aalen-Oberalfingen,  
Germany

[73] Assignee: **Eisen- und Drahtwerk Erlau  
Aktiengesellschaft**, Aalen, Germany

[\*\*] Term: **14 Years**

[21] Appl. No.: **10,839**

[22] Filed: **Jul. 19, 1993**

[30] **Foreign Application Priority Data**

Jan. 19, 1993 [DE] Germany ..... 93 00 355.2

[52] **U.S. Cl.** ..... **D6/362; D6/335; D6/381**

[58] **Field of Search** ..... **D6/334, 335, 336,  
D6/362, 369, 379, 381, 500, 501, 502;  
397/232**

[56] **References Cited**

**U.S. PATENT DOCUMENTS**

- D. 239,150 3/1976 Meade ..... D6/335
- D. 285,151 8/1986 Molinari ..... D6/381
- D. 345,469 3/1994 Wirth ..... D6/381 X

**OTHER PUBLICATIONS**

Design, Aug. 1982, p. 49, Seating Unit at bottom left.  
Interiors New Product Portfolio, 1985, p. 14, Seating Unit at  
bottom left.

Kroin, ©1991, p. 8, Park Seat at top right.

Kroin, ©1991, p. 9, Park Seat at top left.

*Primary Examiner*—Alan P. Douglas

*Assistant Examiner*—Gary D. Watson

*Attorney, Agent, or Firm*—Robert W. Becker & Associates

[57] **CLAIM**

The ornamental design for a seat, as shown and described.

**DESCRIPTION**

FIG. 1 is a perspective view of a seat showing my new

design;

FIG. 2 is a top view thereof;

FIG. 3 is a front view thereof;

FIG. 4 is a rear view thereof;

FIG. 5 is a bottom view thereof;

FIG. 6 is a view from the left end thereof, with the right end  
view being a mirror image thereof;

FIG. 7 is a perspective view of a seat showing a variation of  
my new design;

FIG. 8 is a top view thereof;

FIG. 9 is a front view thereof;

FIG. 10 is a view from the left side thereof;

FIG. 11 is a rear view thereof;

FIG. 12 is a bottom view thereof;

FIG. 13 is a perspective view of a seat showing a variation  
of my new design;

FIG. 14 is a top view thereof;

FIG. 15 is a front view thereof, with the rear view being a  
mirror image thereof;

FIG. 16 is a view from the left end thereof, with the right end  
view being a mirror image thereof;

FIG. 17 is a bottom view thereof;

FIG. 18 is a perspective view of a seat showing a variation  
of my new design;

FIG. 19 is a top view thereof;

FIG. 20 is a front view thereof;

FIG. 21 is a bottom view thereof; and,

FIG. 22 is a view from the right end thereof, with the left end  
view being a mirror image thereof.

The mesh-like seat covering is continuous but has been  
shown fragmented throughout the drawings. For attachment  
purposes, it wraps around the tubular frame to the under-  
neath side but this has not been shown for ease of illustra-  
tion.

**1 Claim, 14 Drawing Sheets**

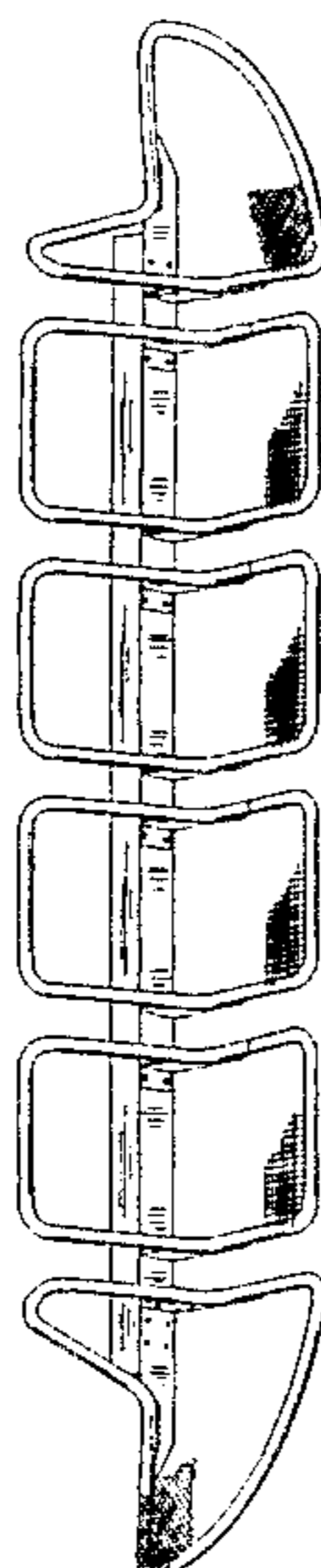

FIG-1

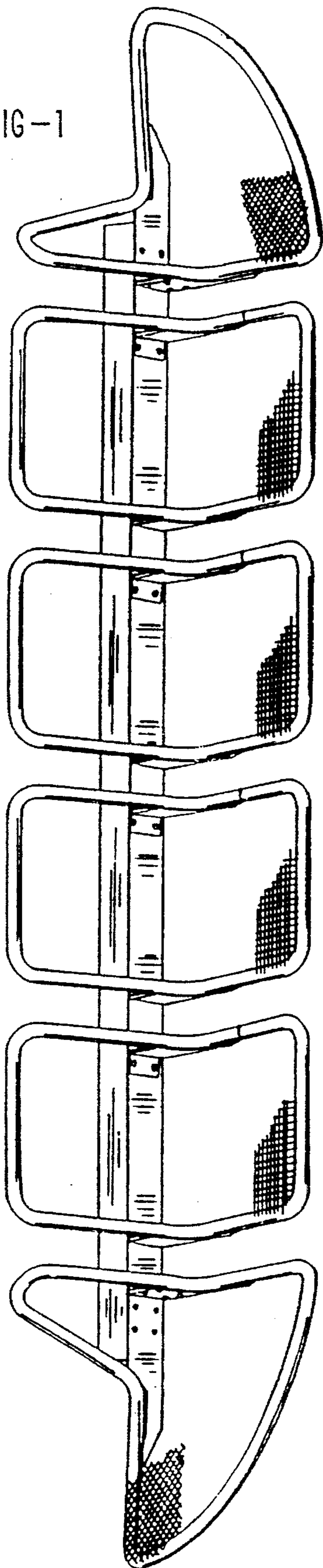

FIG-2

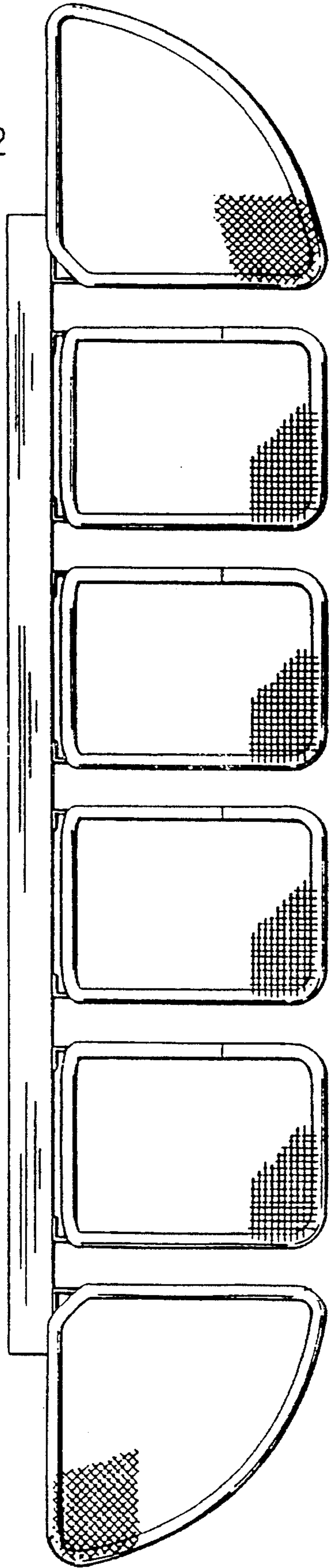

FIG - 3

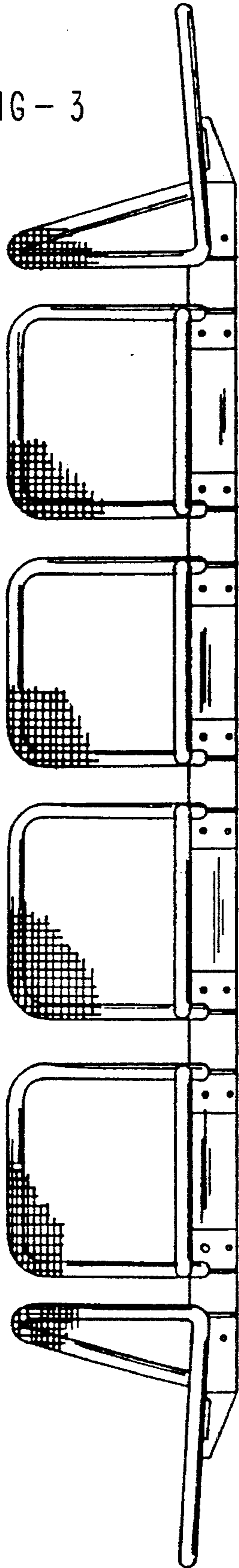
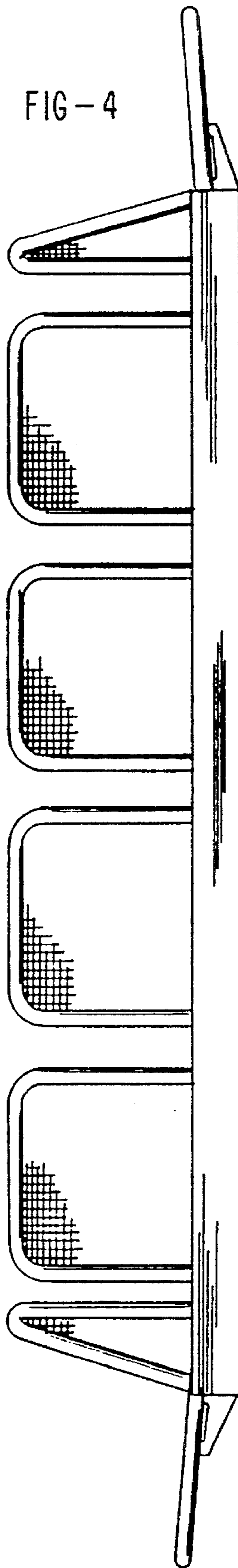

FIG - 4



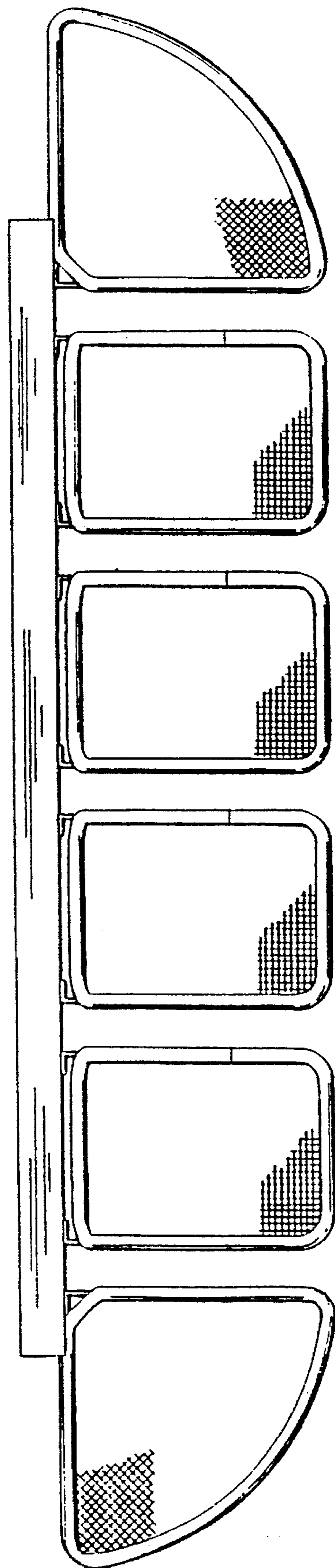

FIG-5

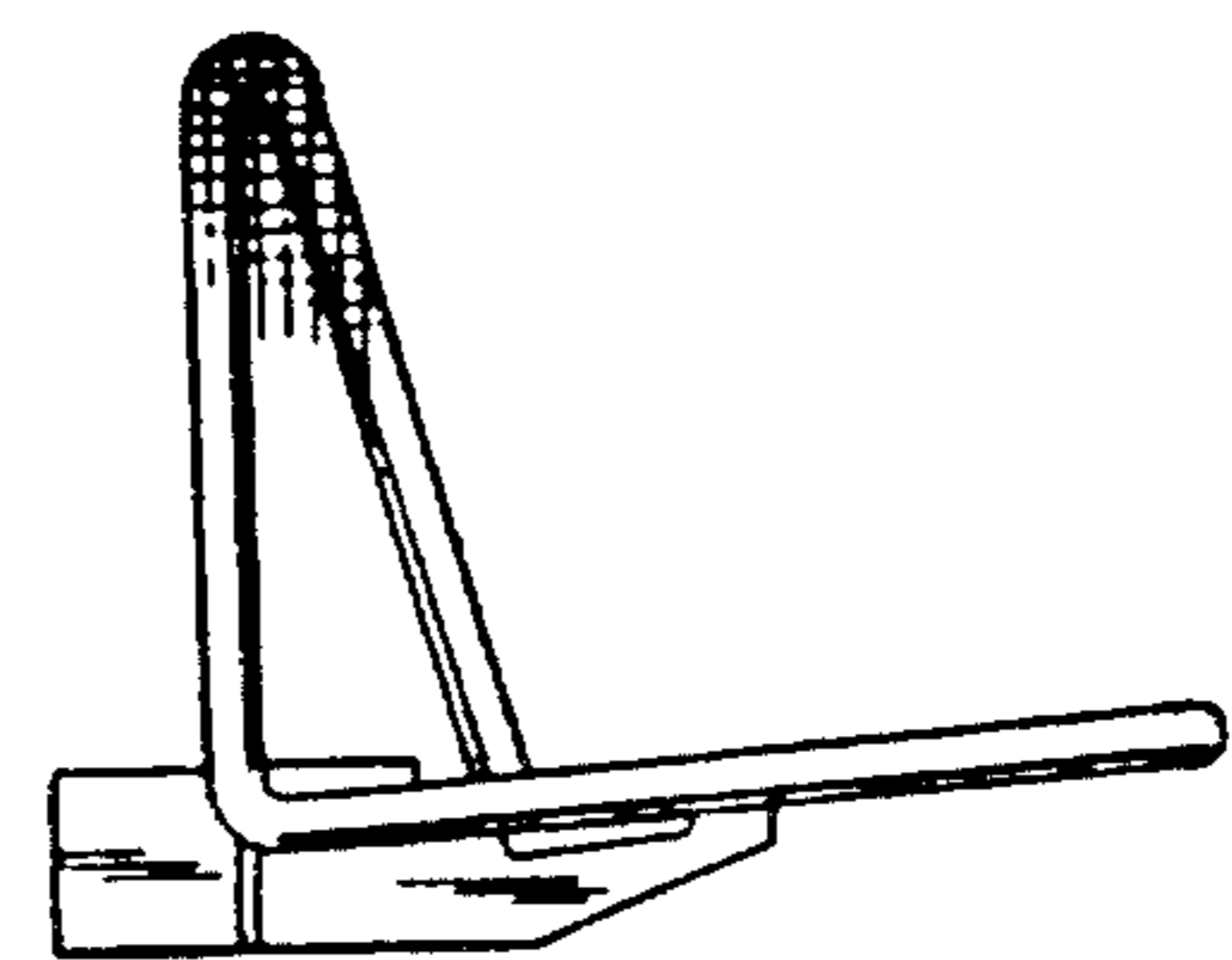

FIG-6

FIG-7

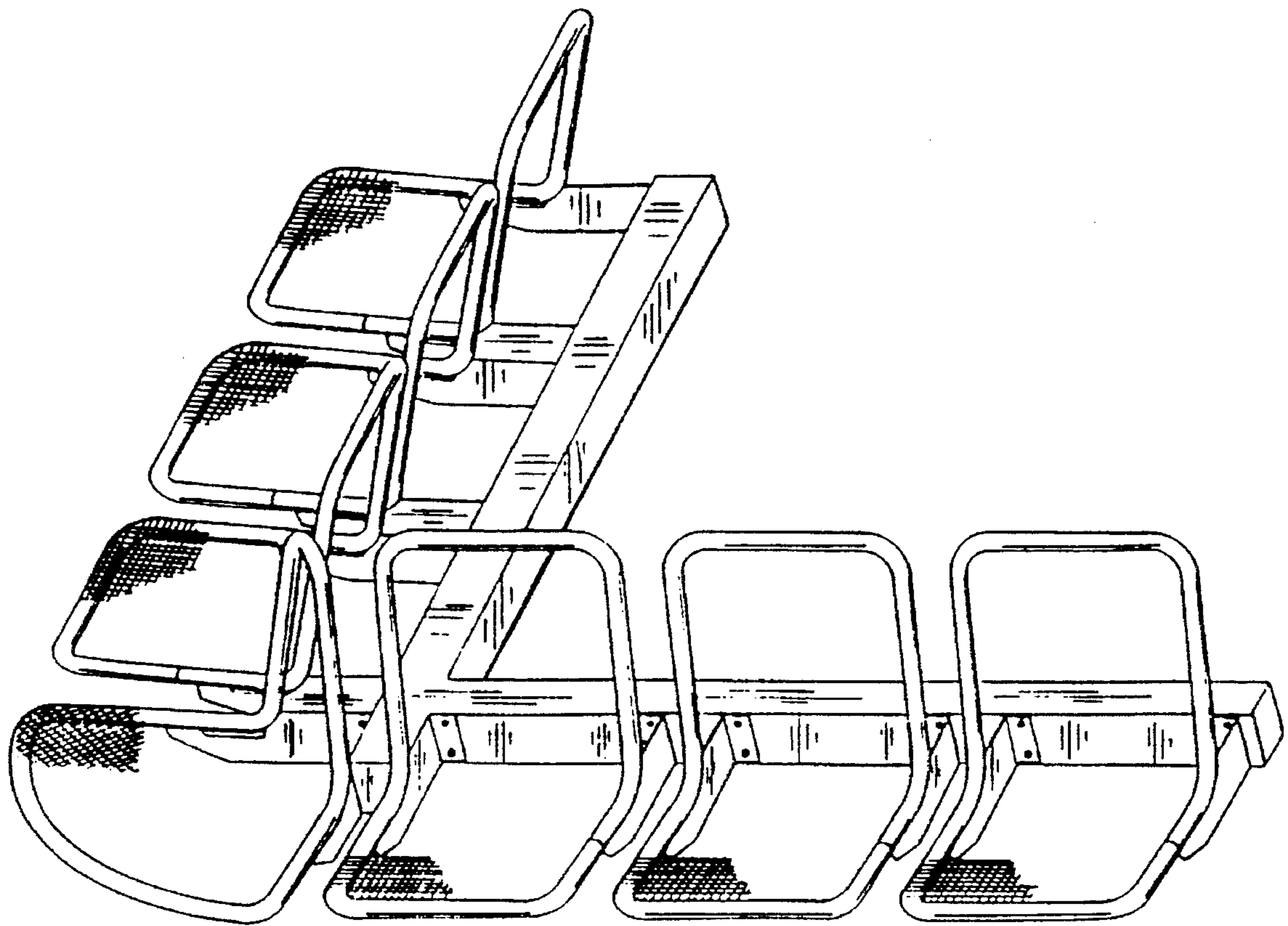

FIG - 8

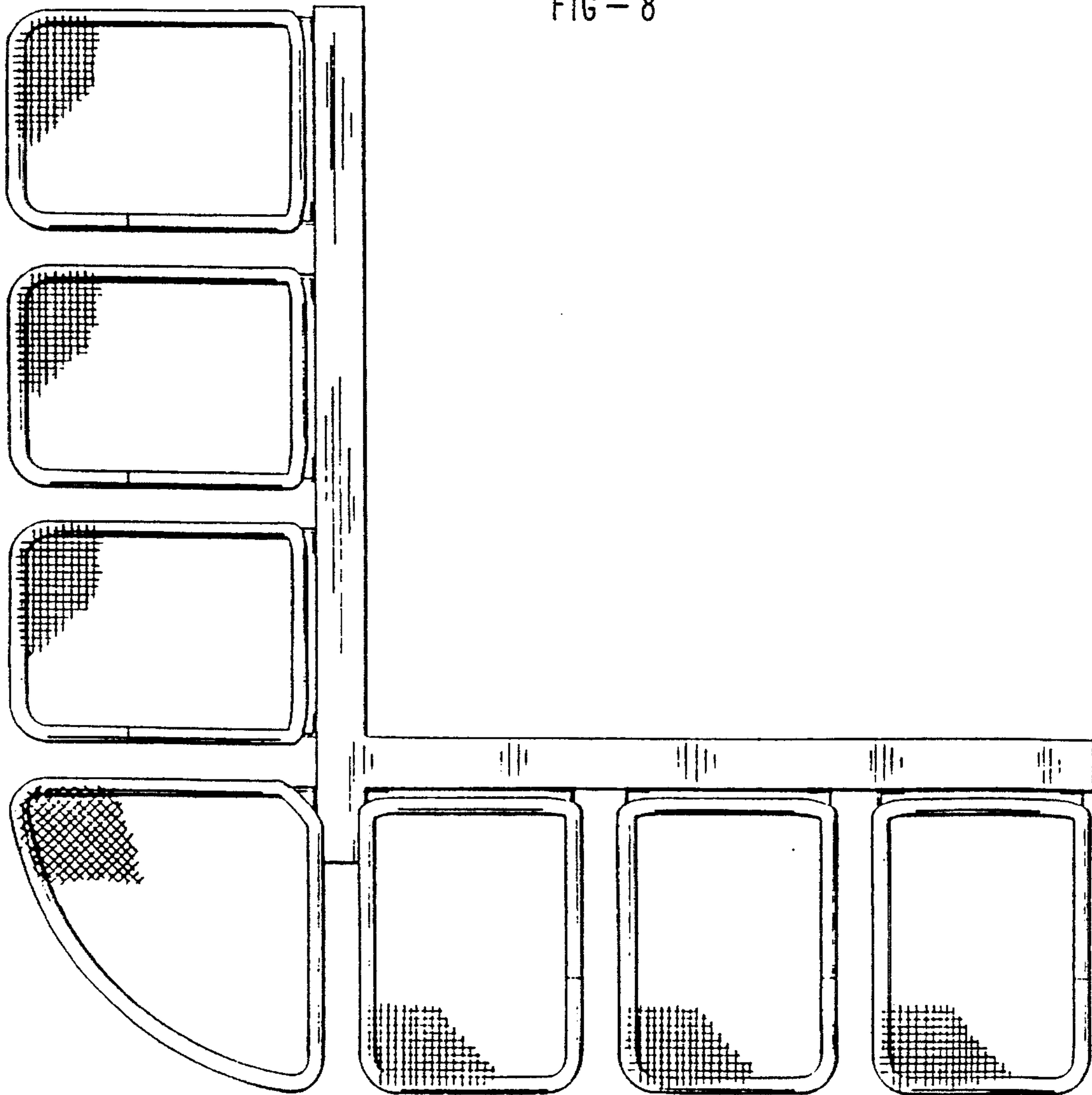

FIG-9

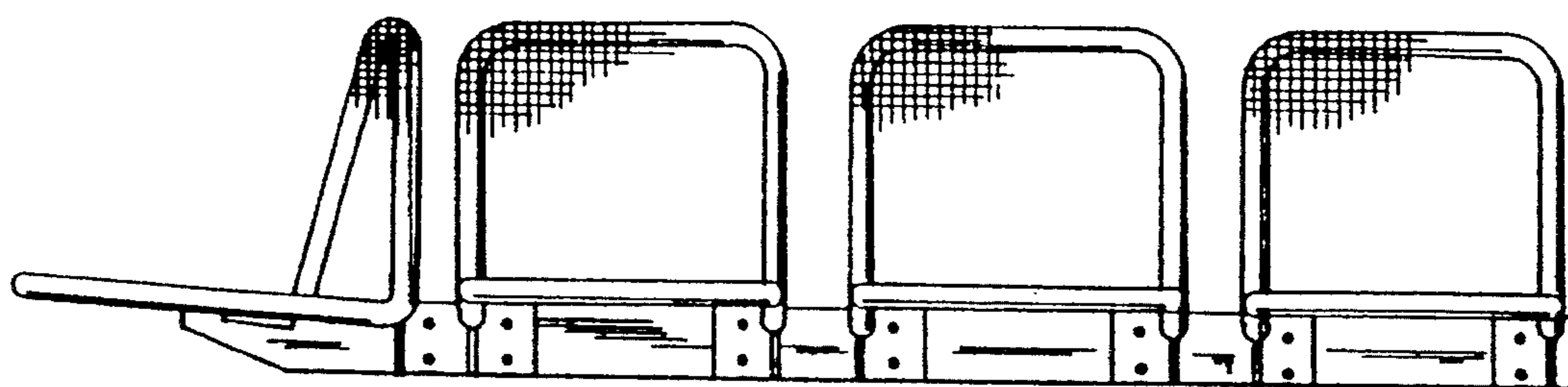

FIG-10

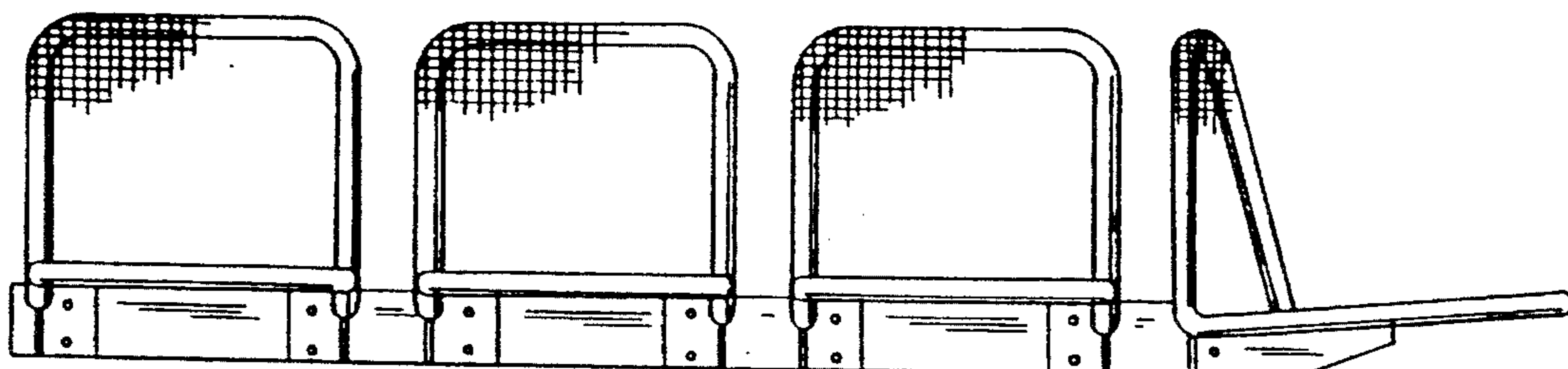
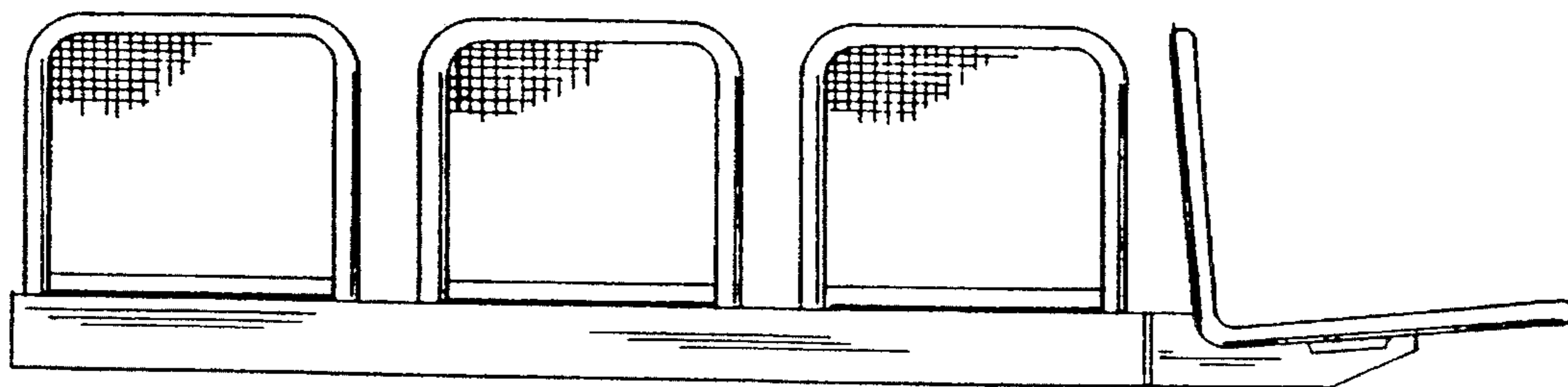
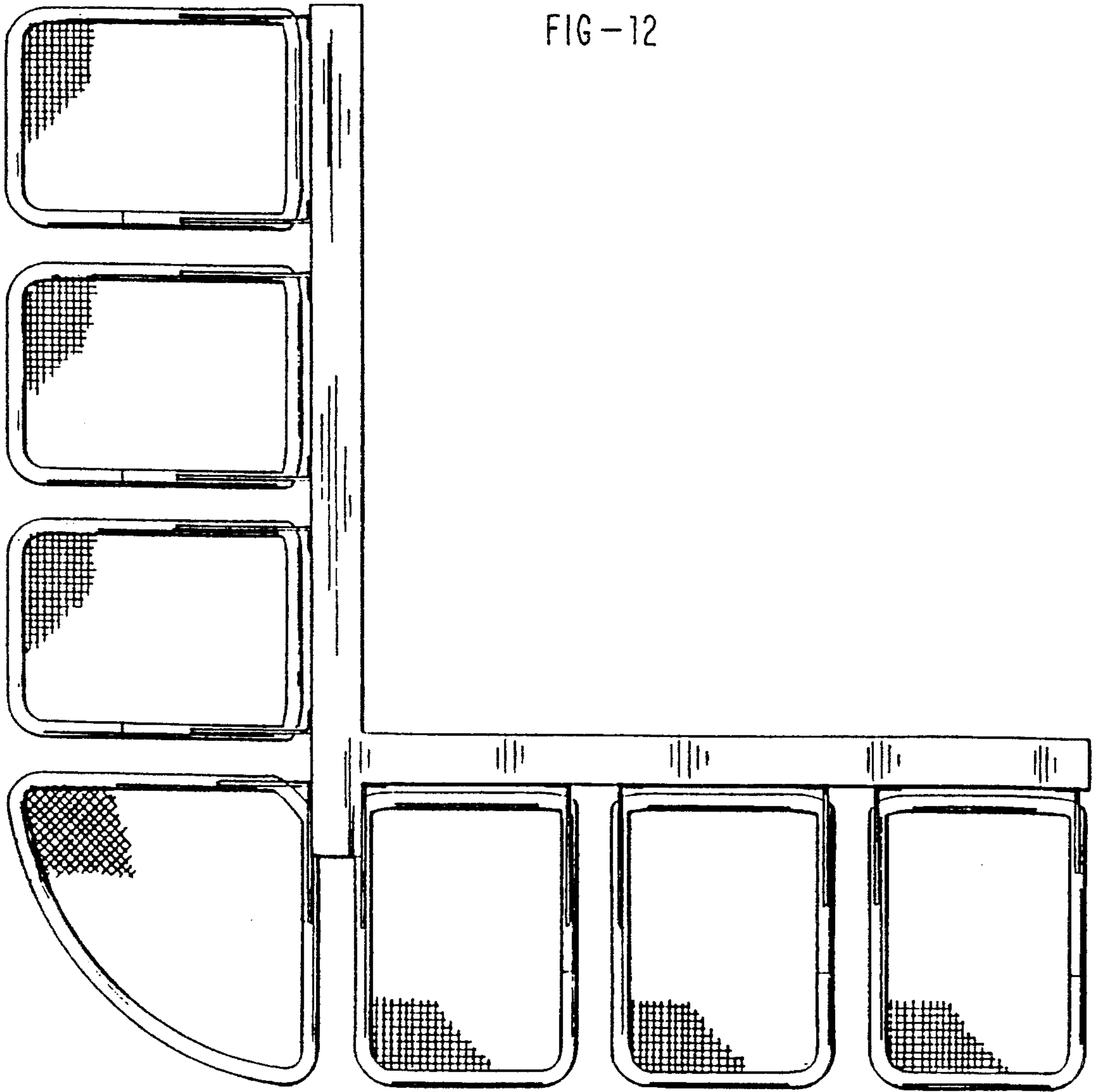

FIG-11







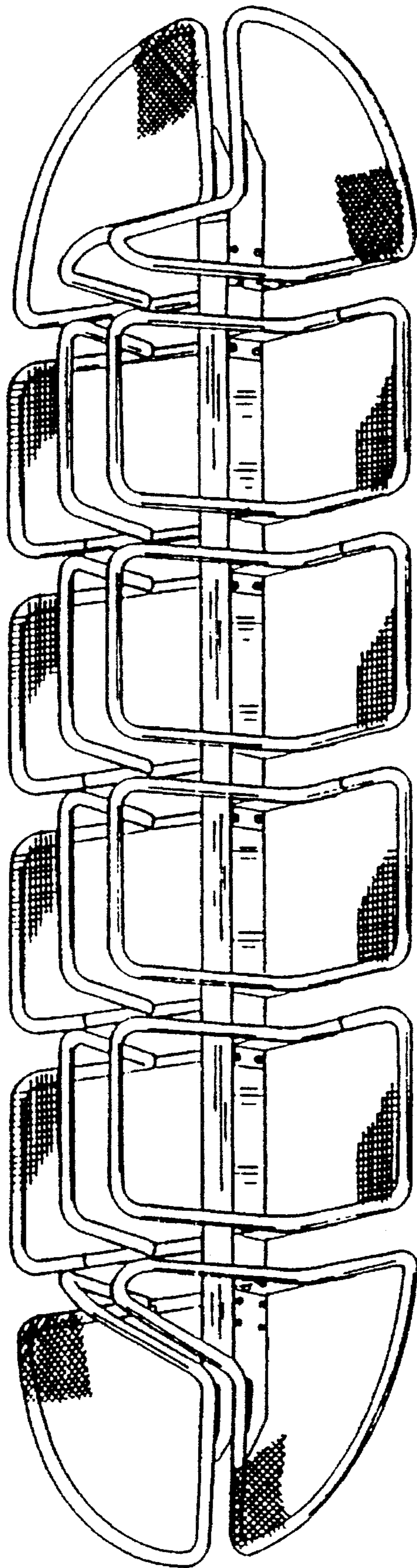

FIG-13

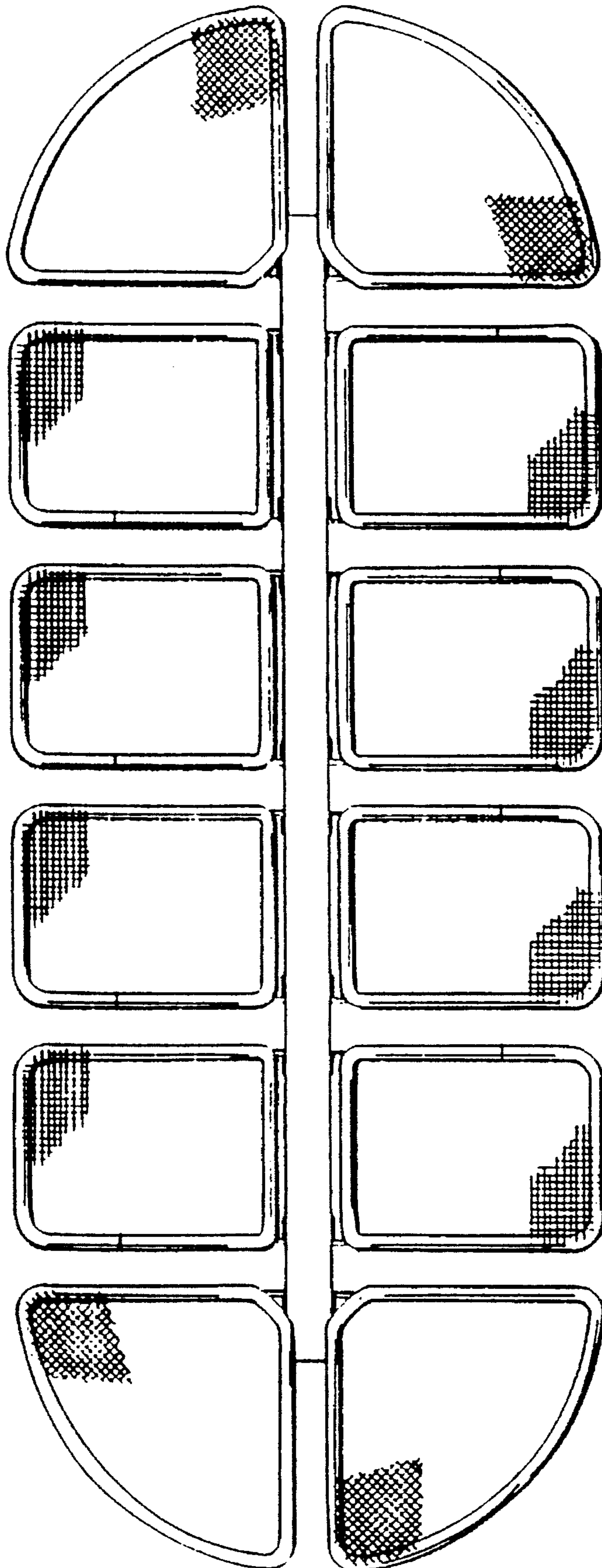

FIG-14

FIG-15

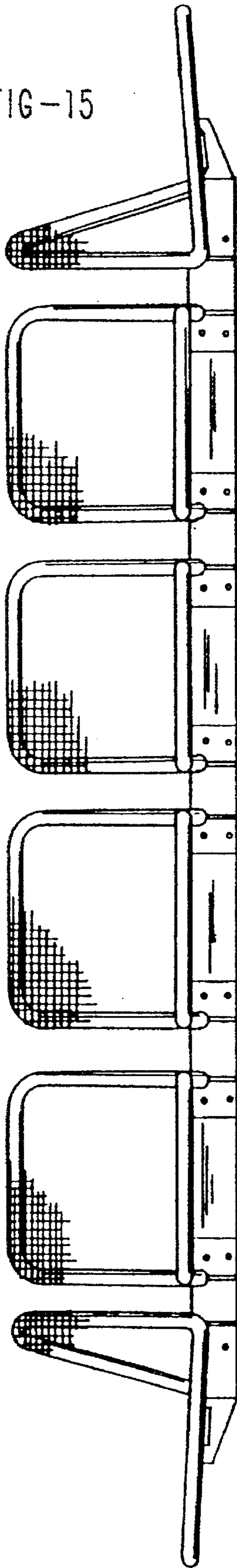
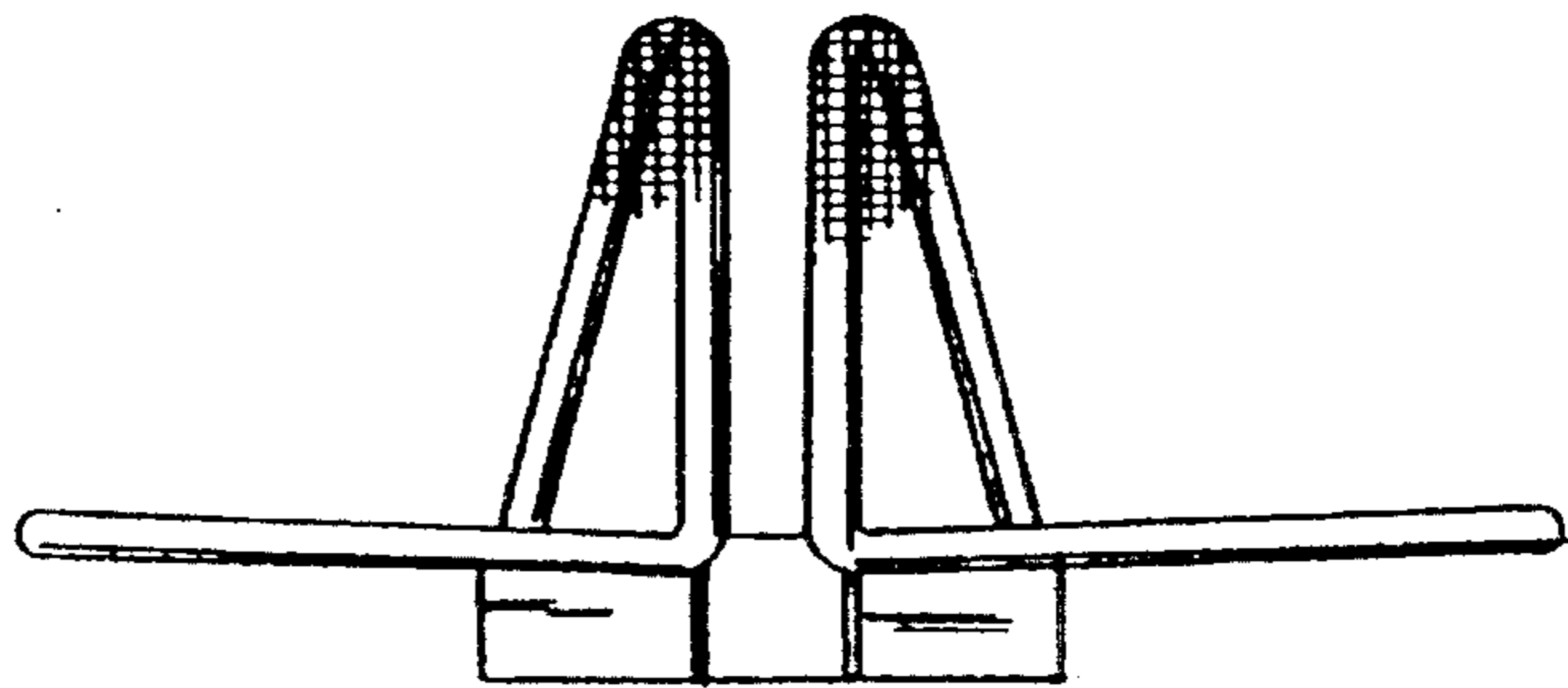

FIG-16



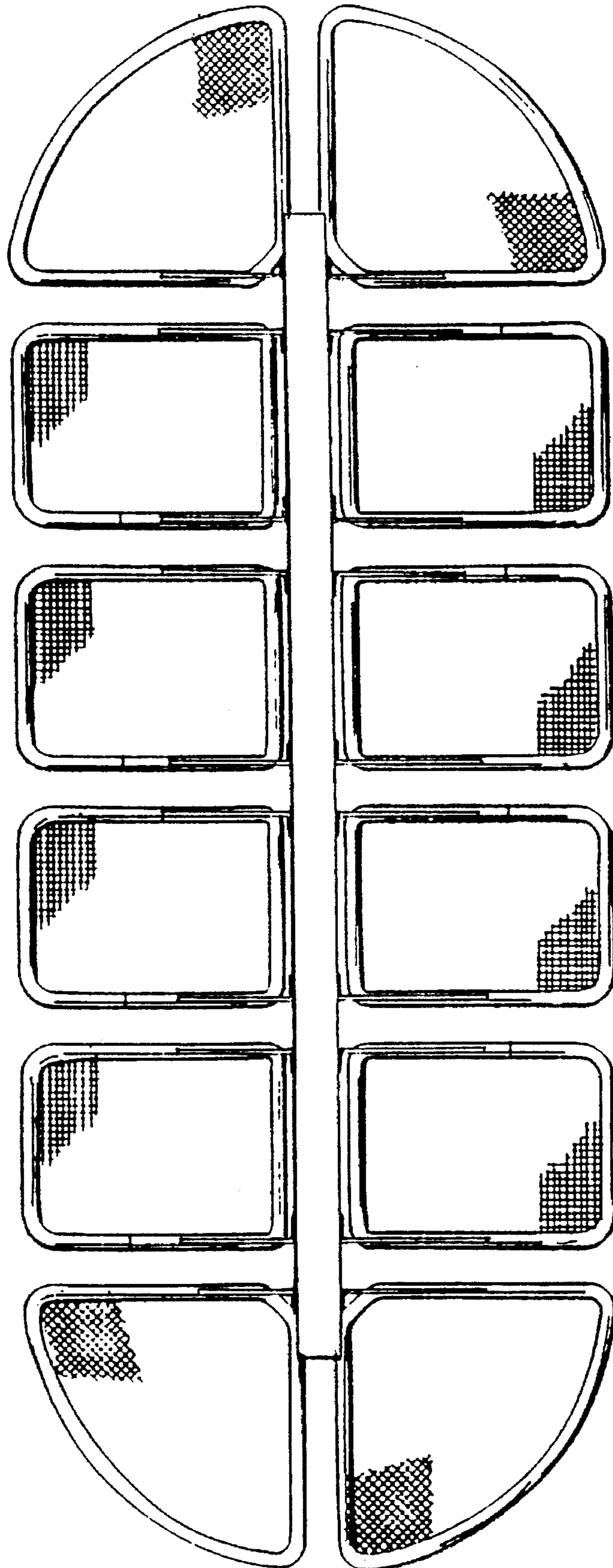

FIG-17

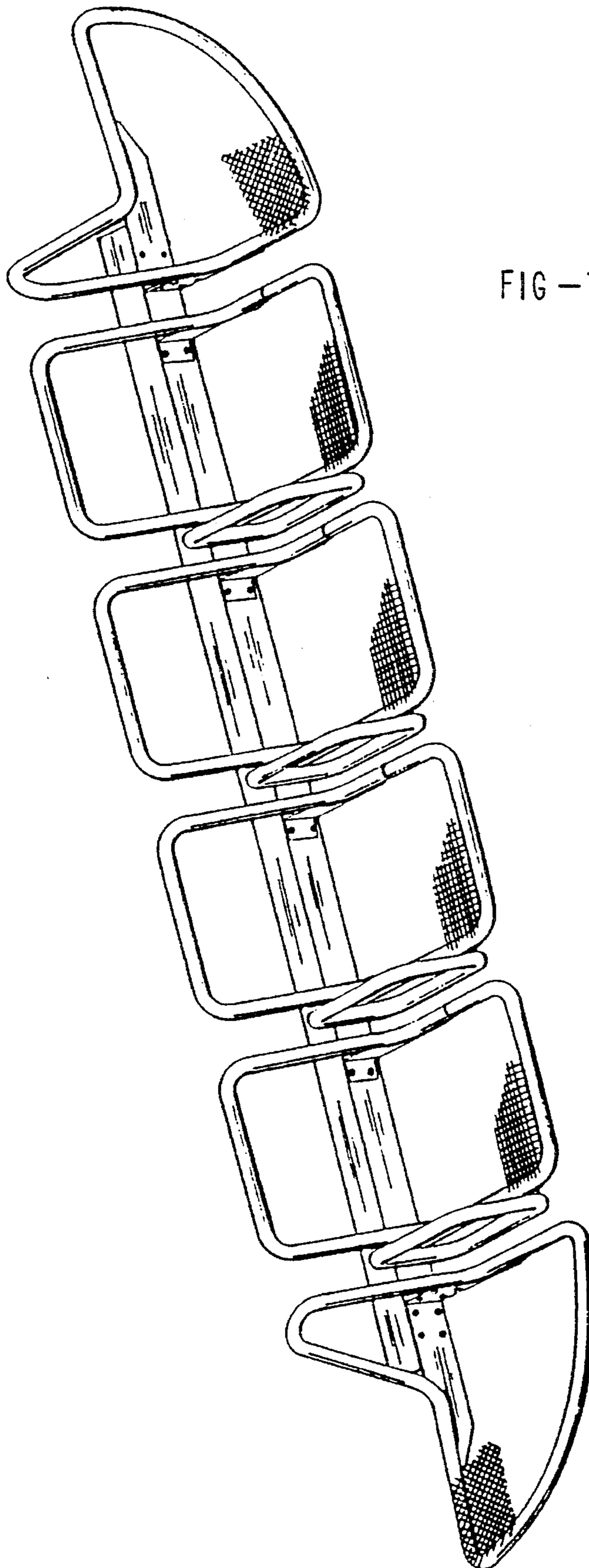

FIG-18

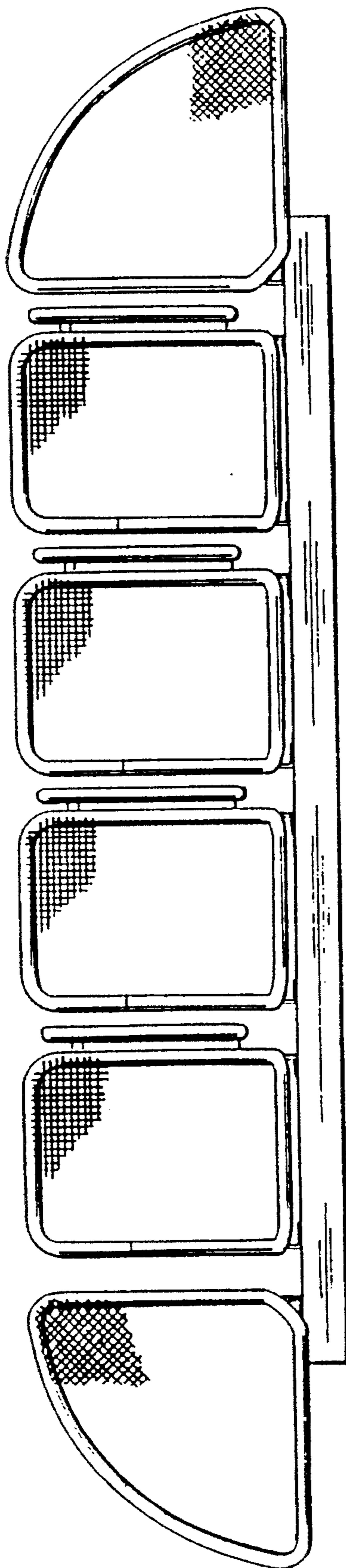

FIG-19

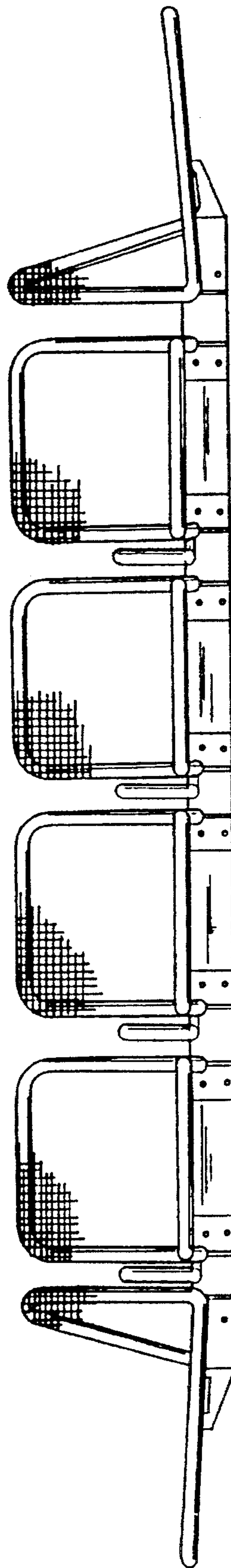

FIG-20

FIG-21

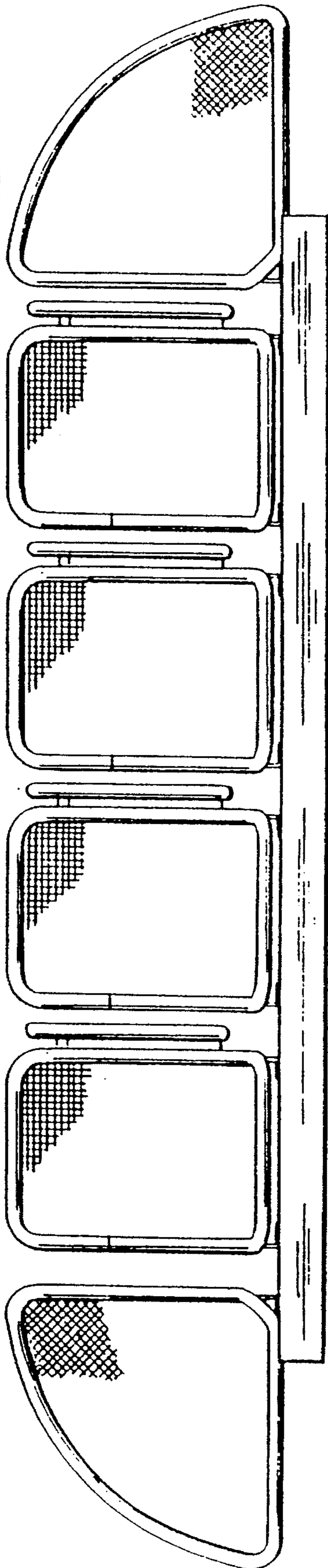

FIG-22

