



US00D366094S

United States Patent [19]

[11] Patent Number: **Des. 366,094**

Duncan et al.

[45] Date of Patent: ***** Jan. 9, 1996**

[54] **COUNTER-TOP WATER PURIFICATION SYSTEM**

[75] Inventors: **Matthew F. Duncan**, Westminster, Calif.; **Robert A. Slovak**, Incline Village, Nev.; **David R. Spears**, Laguna Niguel, Calif.; **Jack P. Slovak**, Incline Village, Nev.

[73] Assignee: **Water Factory Systems, Inc.**, Irvine, Calif.

[*] Notice: The portion of the term of this patent subsequent to Jun. 22, 2006, has been disclaimed.

[**] Term: **14 Years**

[21] Appl. No.: **493,855**

[22] Filed: **Mar. 14, 1990**

[52] U.S. Cl. **D23/209**

[58] Field of Search D23/200, 207-210; 210/136, 205-206, 231, 241, 244-245, 257.1-257.2, 258, 260-261, 269, 275, 282, 288-290, 295, 321.6, 321.78, 416.3, 443-449

[56] **References Cited**

U.S. PATENT DOCUMENTS

D. 230,358 2/1974 Mann D23/209

D. 240,624 7/1976 MacMurray D23/207
D. 249,051 8/1978 Hannote D23/207
D. 249,701 9/1978 Maples et al. D23/207
3,342,335 9/1967 Gamundi et al. 210/448 X
4,152,262 5/1979 Roze 210/257.1 X

Primary Examiner—Susan J. Lucas
Assistant Examiner—M. H. Tung
Attorney, Agent, or Firm—Leonard Tachner

[57] **CLAIM**

The ornamental design for a counter-top water purification system, as shown and described.

DESCRIPTION

FIG. 1 is a perspective view of a counter-top water purification system showing our new design;

FIG. 2 is a front elevational view thereof;

FIG. 3 is a rear elevational view thereof;

FIG. 4 is a left side elevational view thereof, the right side being a mirror image;

FIG. 5 is a top plan view thereof; and,

FIG. 6 is a bottom plan view thereof.

1 Claim, 3 Drawing Sheets

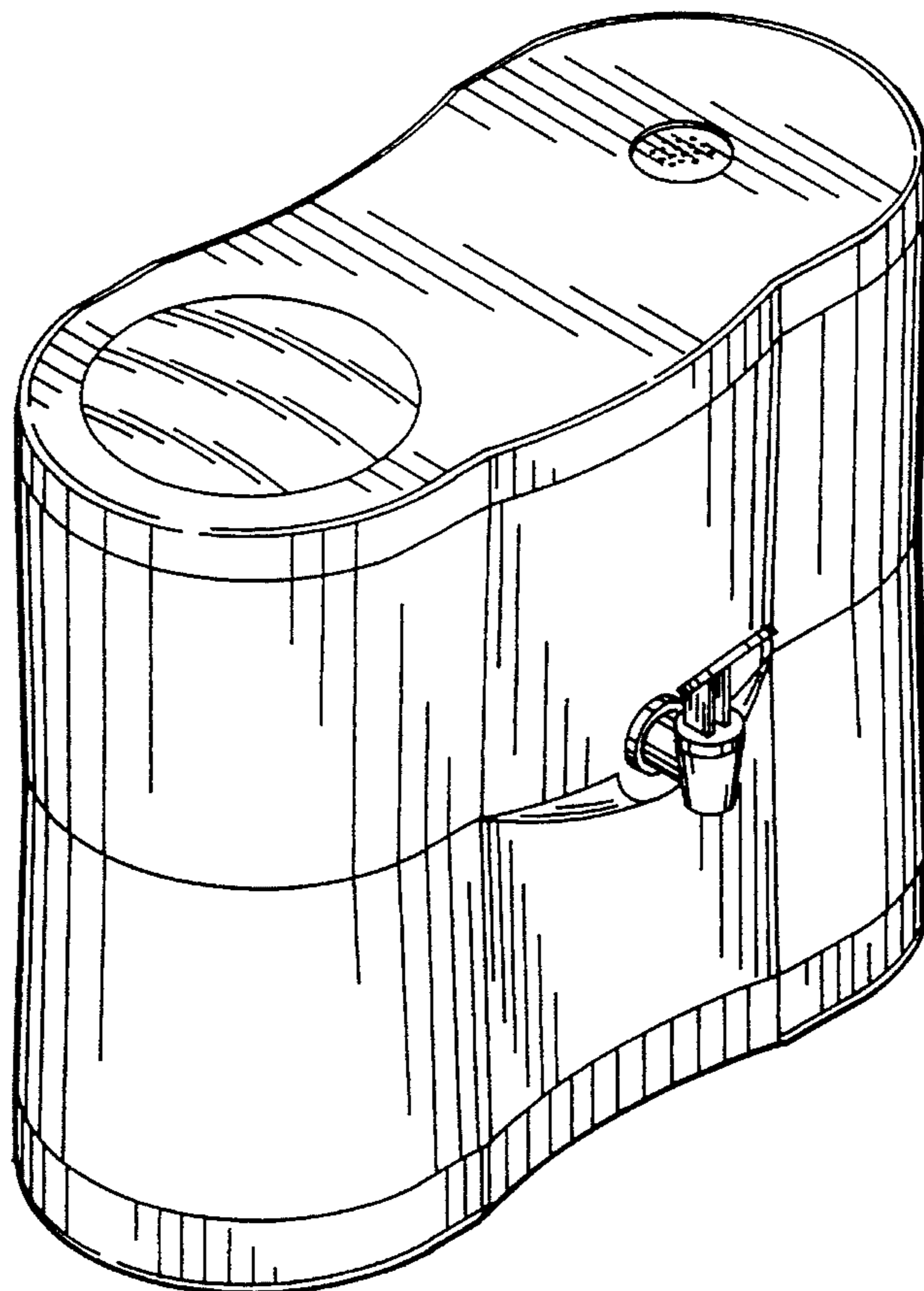

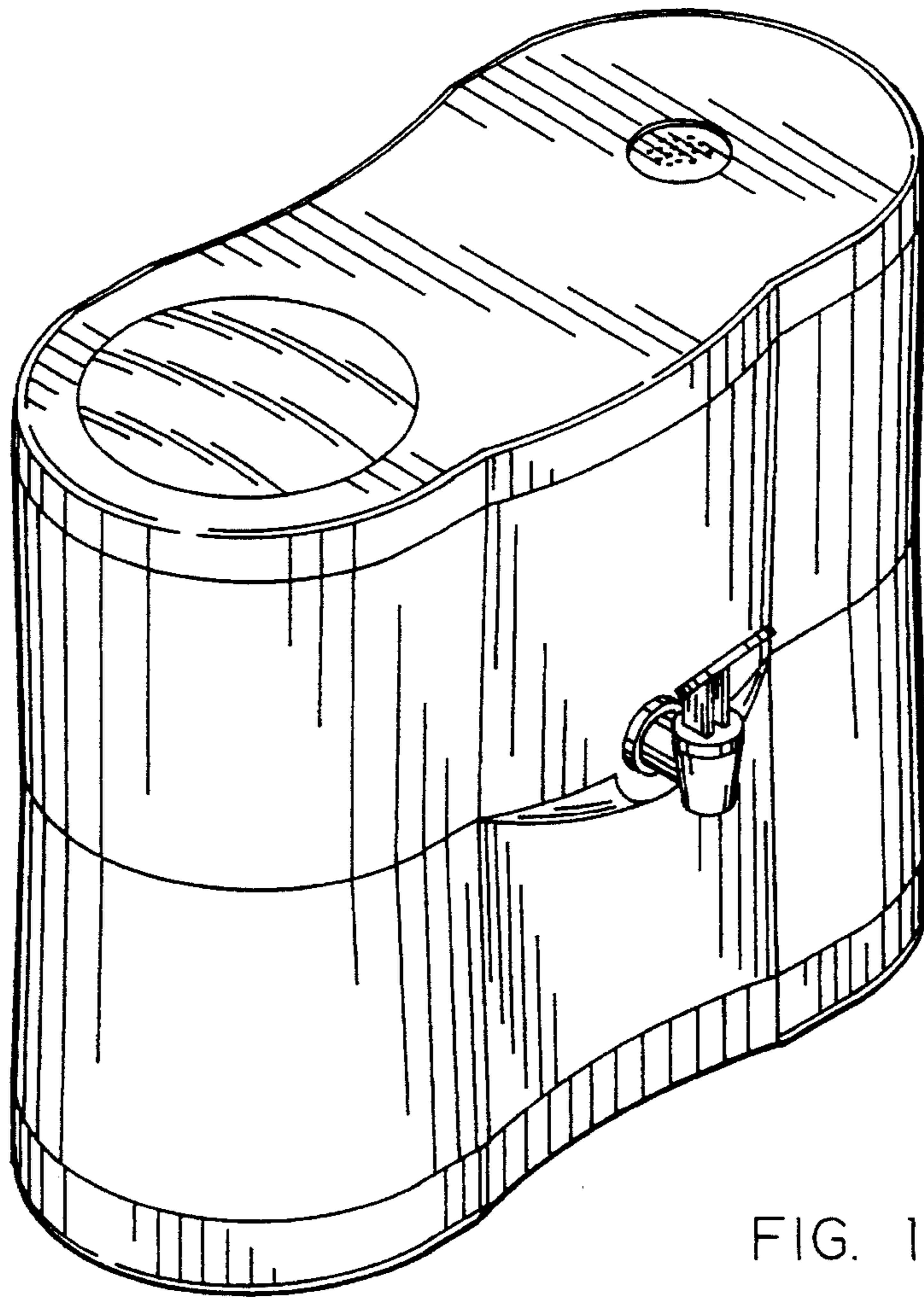
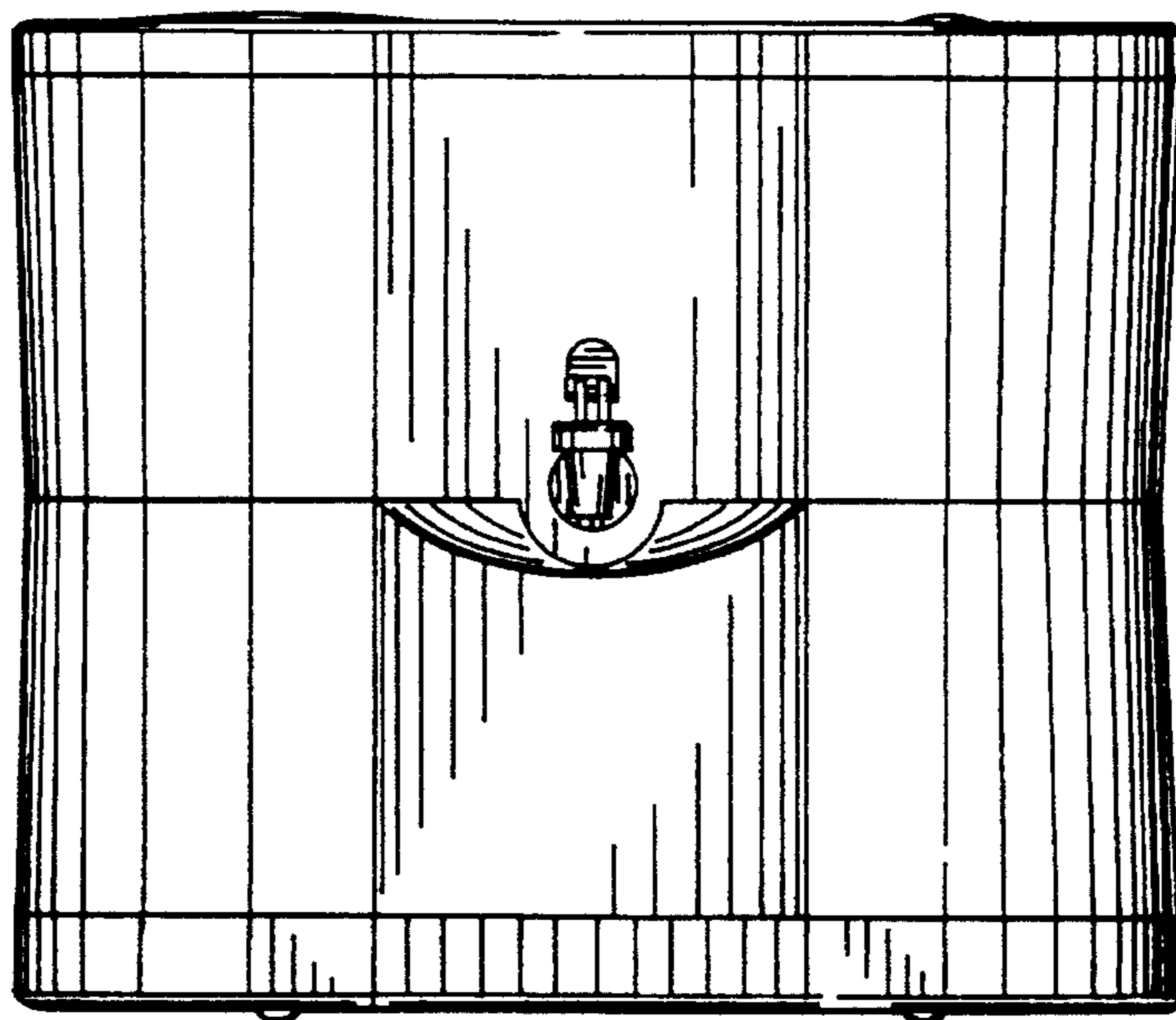

FIG. 1

FIG. 2



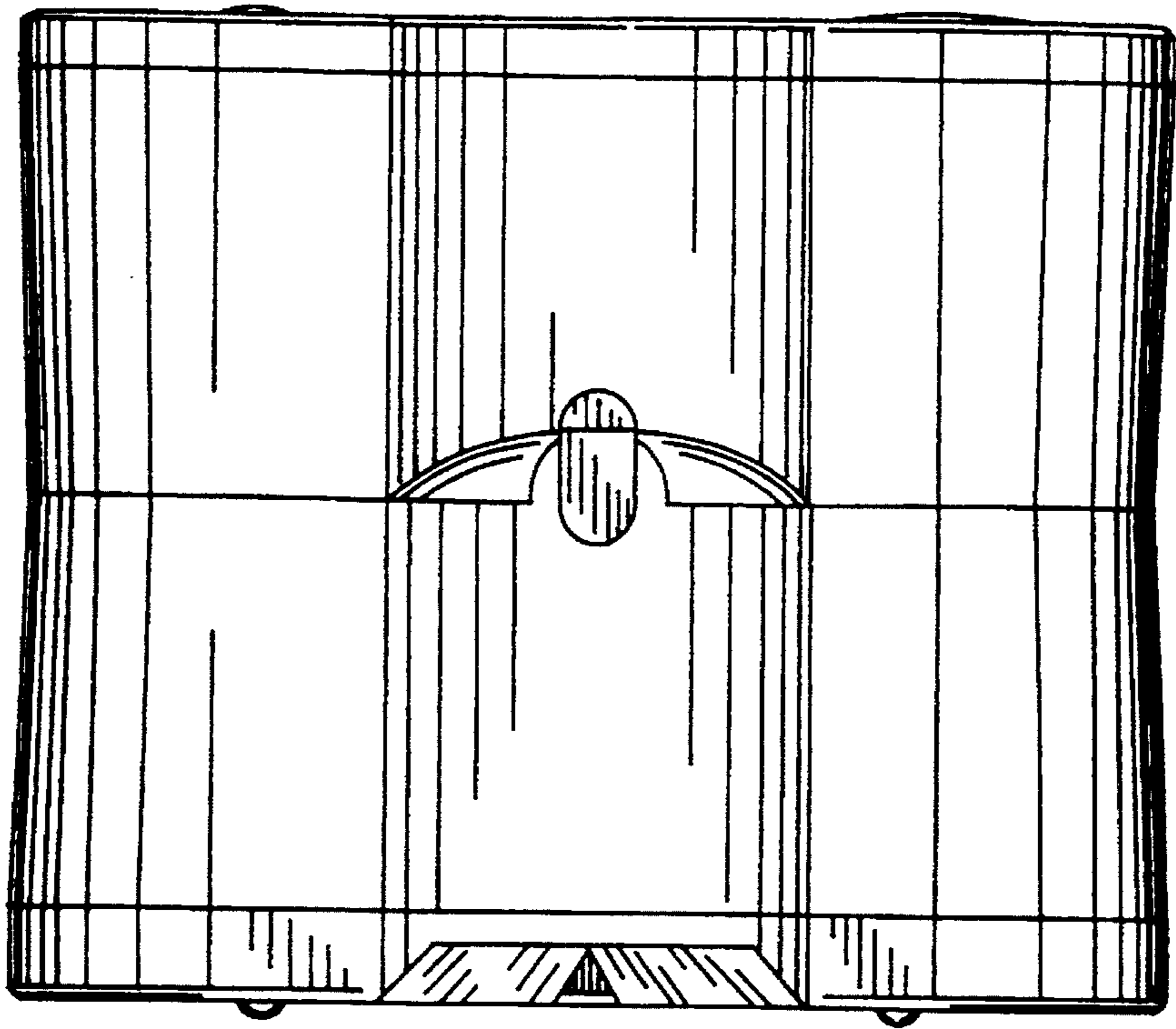

FIG. 3

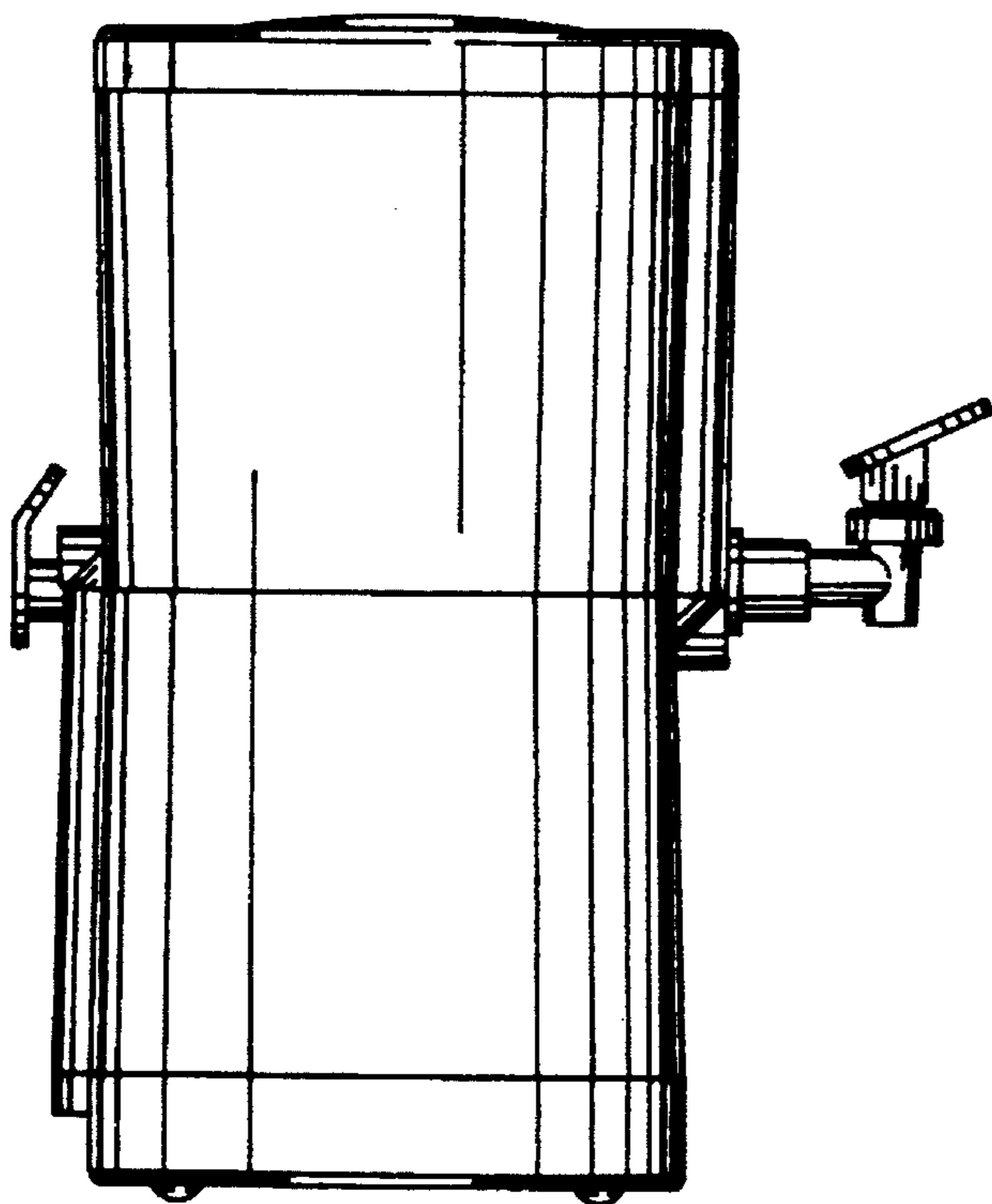

FIG. 4

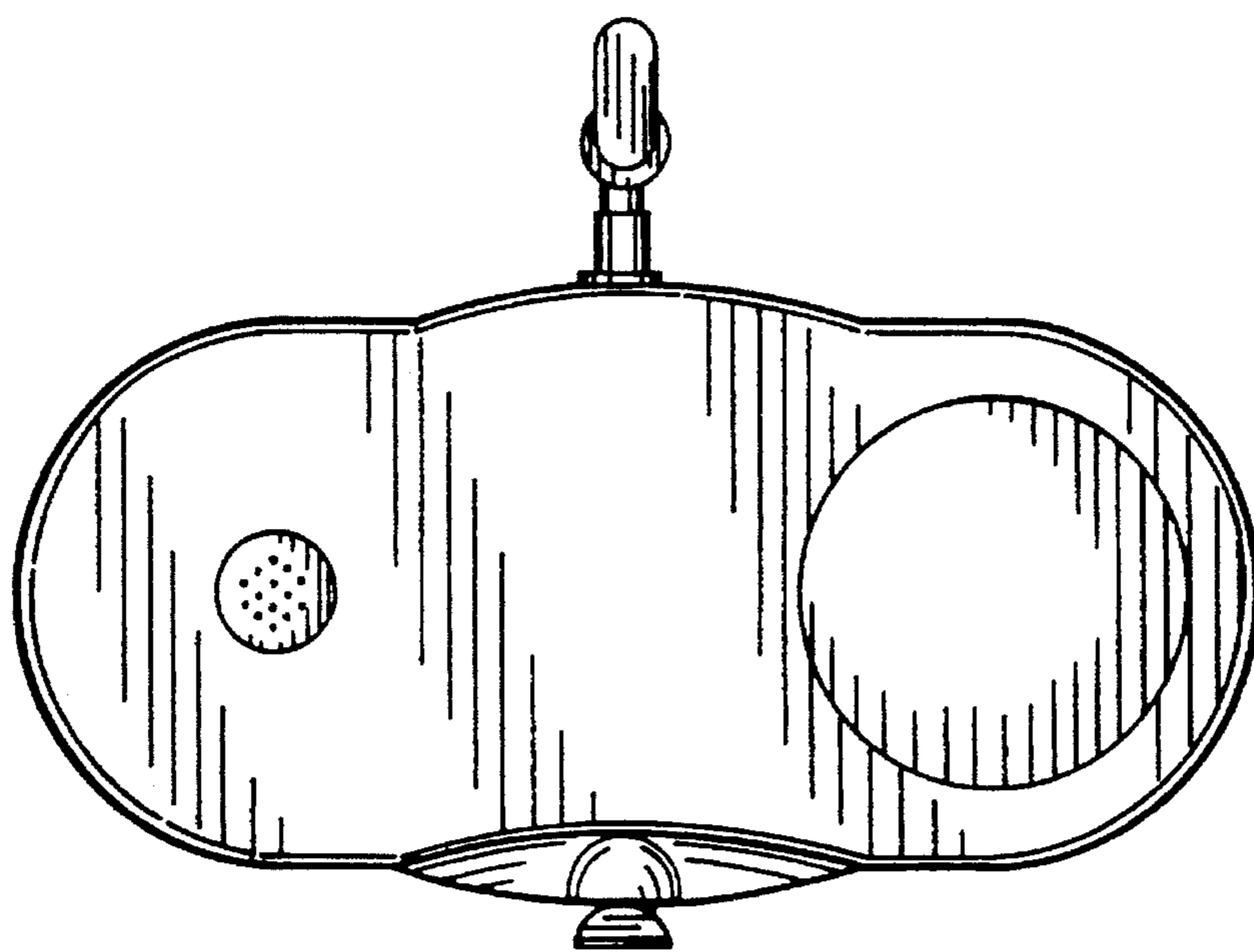

FIG. 5

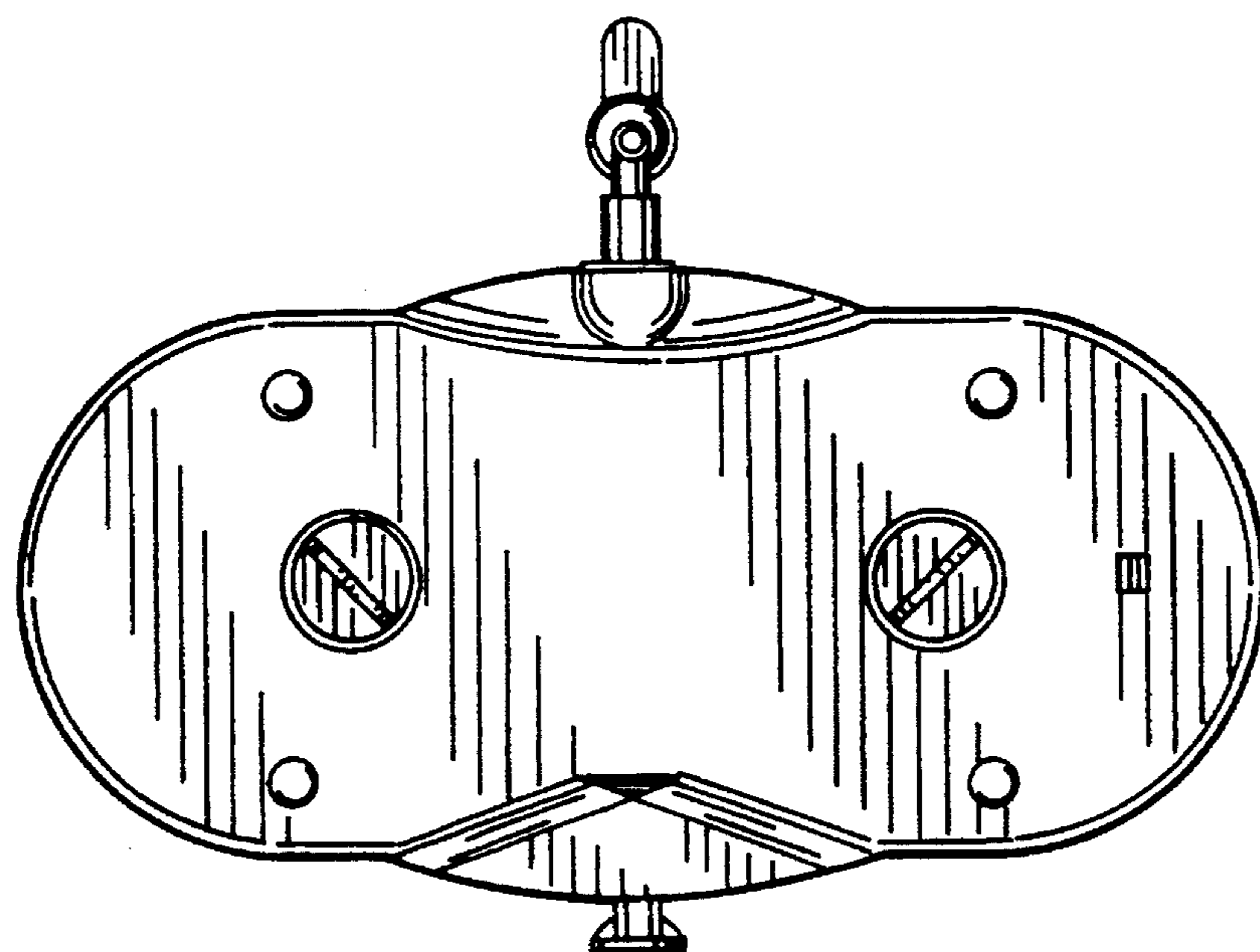

FIG. 6