



US00D366090S

# United States Patent [19]

Sanders

[11] Patent Number: Des. 366,090

[45] Date of Patent: \*\*Jan. 9, 1996

[54] FISHING REEL BAIL RELEASE

4,932,616 6/1990 McMickle et al. .... 242/233  
5,098,031 3/1992 Hitomi ..... 242/233

[76] Inventor: Jerry L. Sanders, P.O. Box 249, York, N.Y. 14592

Primary Examiner—Doris V. Coles

[\*\*] Term: 14 Years

[57] CLAIM

[21] Appl. No.: 10,481

The ornamental design for a fishing reel bail release, as shown and described.

[22] Filed: Jul. 9, 1993

### DESCRIPTION

[52] U.S. Cl. .... D22/137

[58] Field of Search ..... D22/137, 140;  
242/233, 230, 228, 231, 232

FIG. 1 is a front elevational view of the fishing reel bail release showing my new design;

FIG. 2 is a rear elevational view thereof;

FIG. 3 is a left side elevational view thereof;

FIG. 4 is a right side elevational view thereof;

FIG. 5 is a top plan view thereof;

FIG. 6 is a bottom plan view thereof; and,

FIG. 7 is a perspective view thereof.

### [56] References Cited

#### U.S. PATENT DOCUMENTS

4,427,161 1/1984 Sakumoto ..... 242/233  
4,705,228 11/1987 Maruyama et al. .... 242/233  
4,824,040 4/1989 Carpenter et al. .... 242/233  
4,921,188 5/1990 Smith ..... 242/233

1 Claim, 4 Drawing Sheets

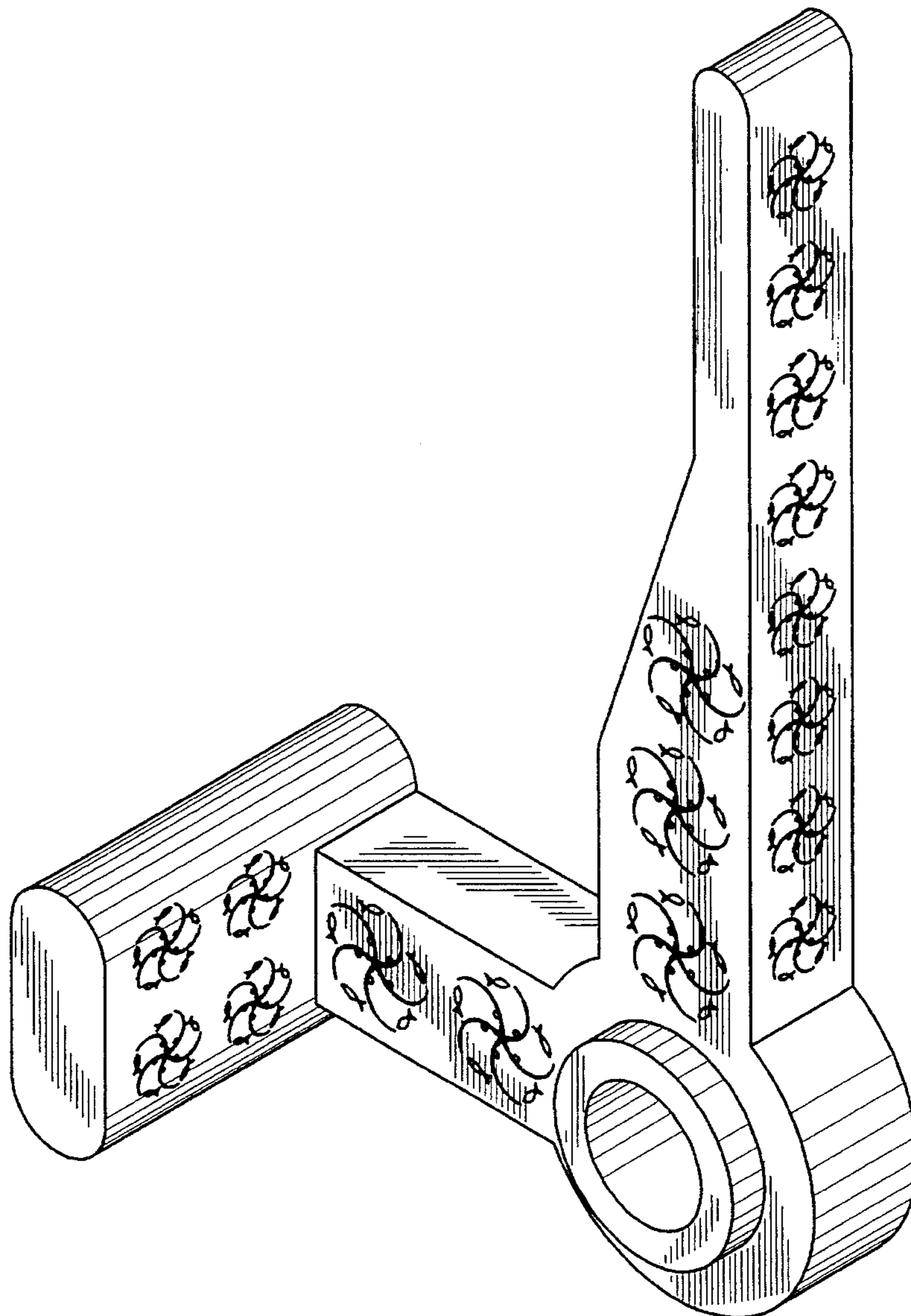

FIG. 1

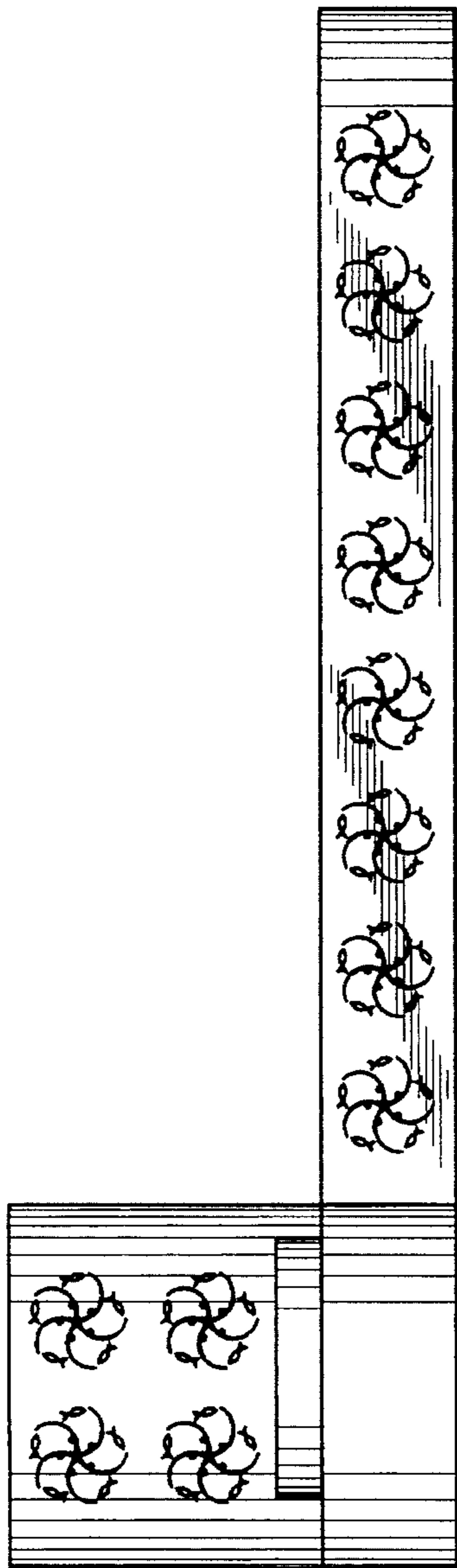

FIG. 2

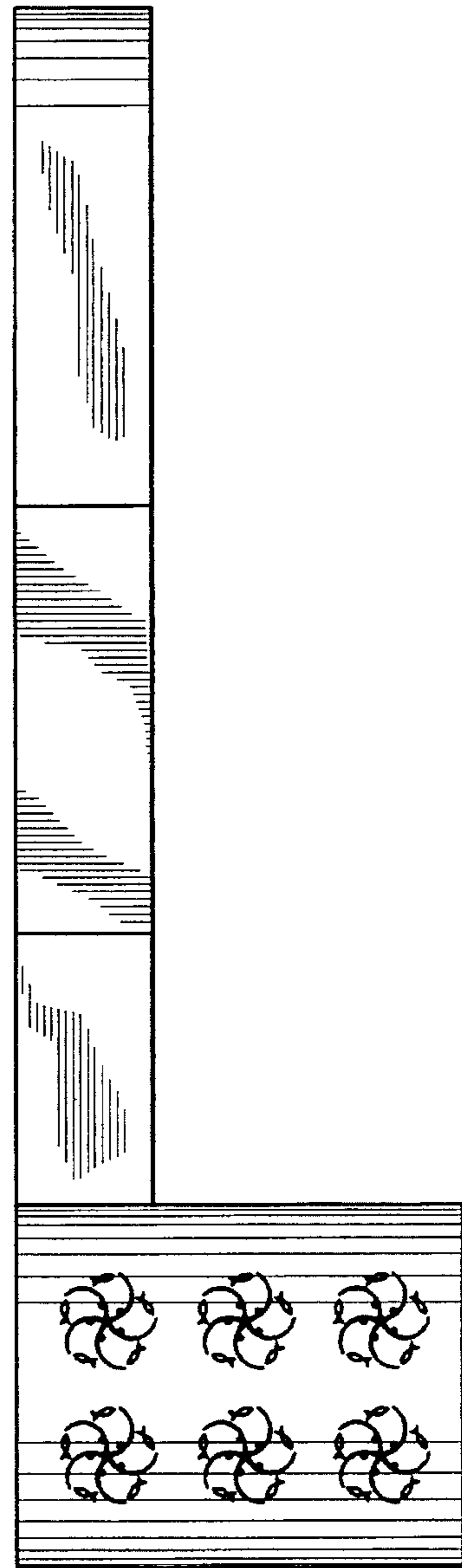

FIG. 3

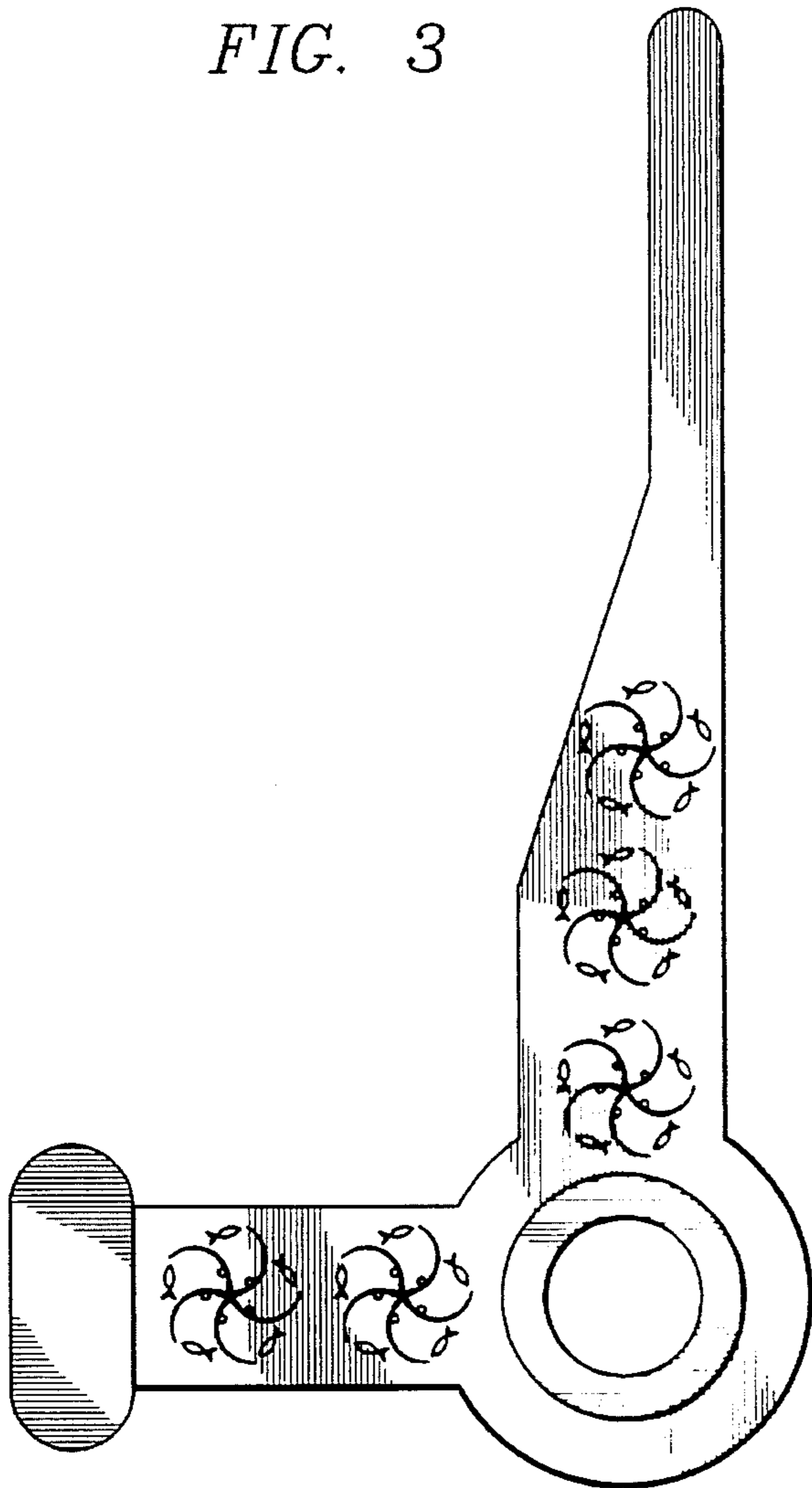

FIG. 4

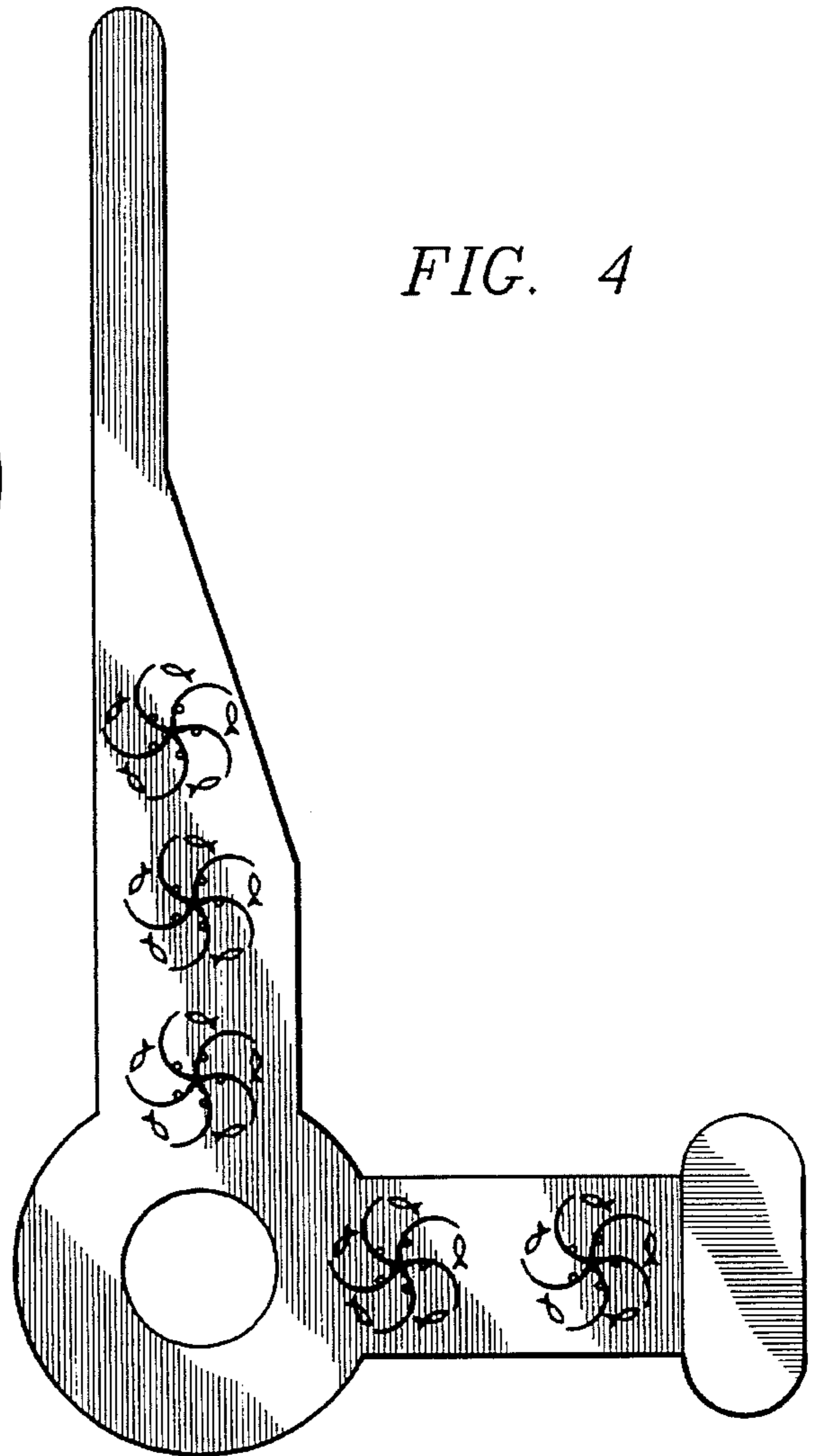

FIG. 5

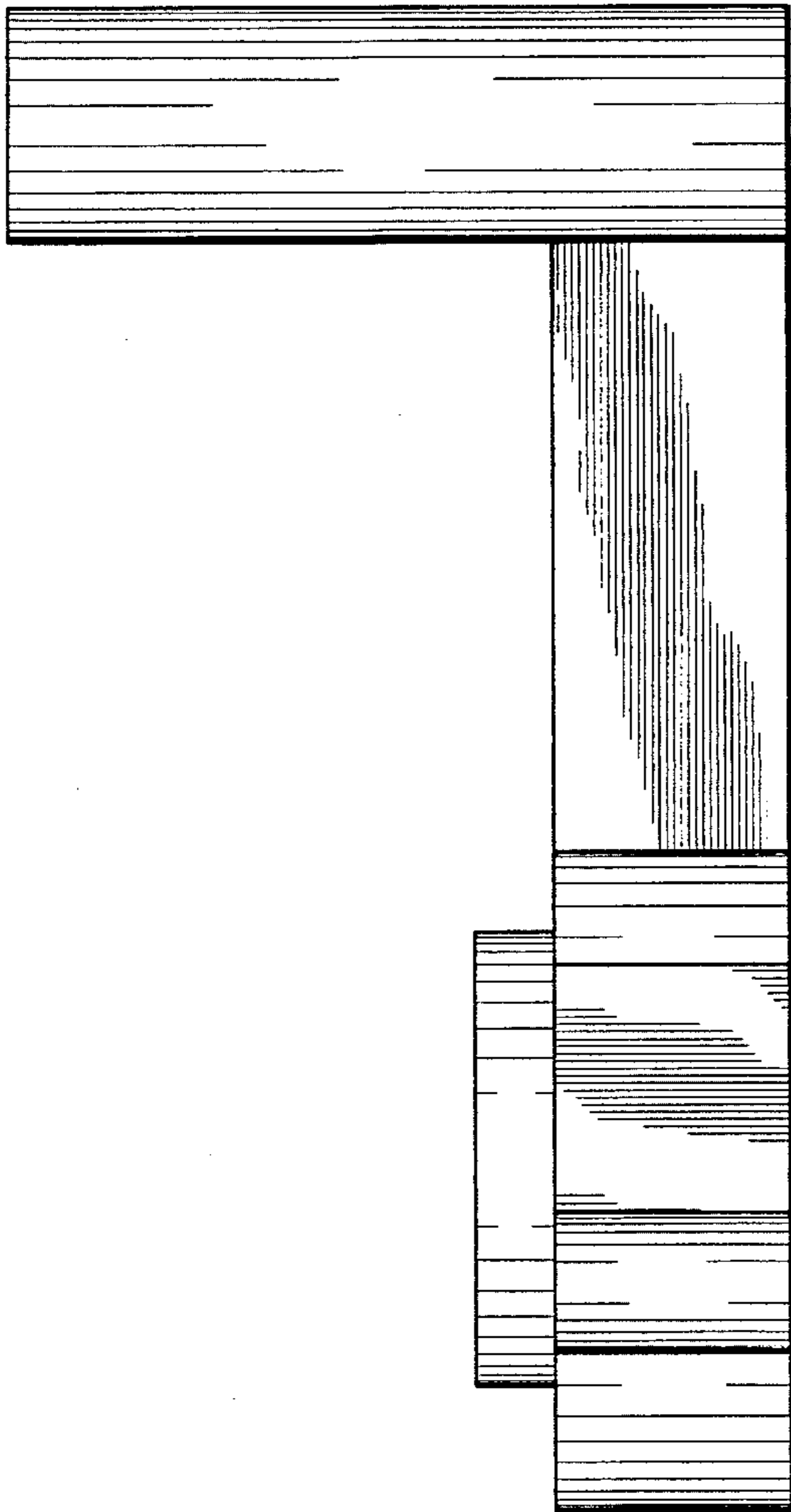

FIG. 6

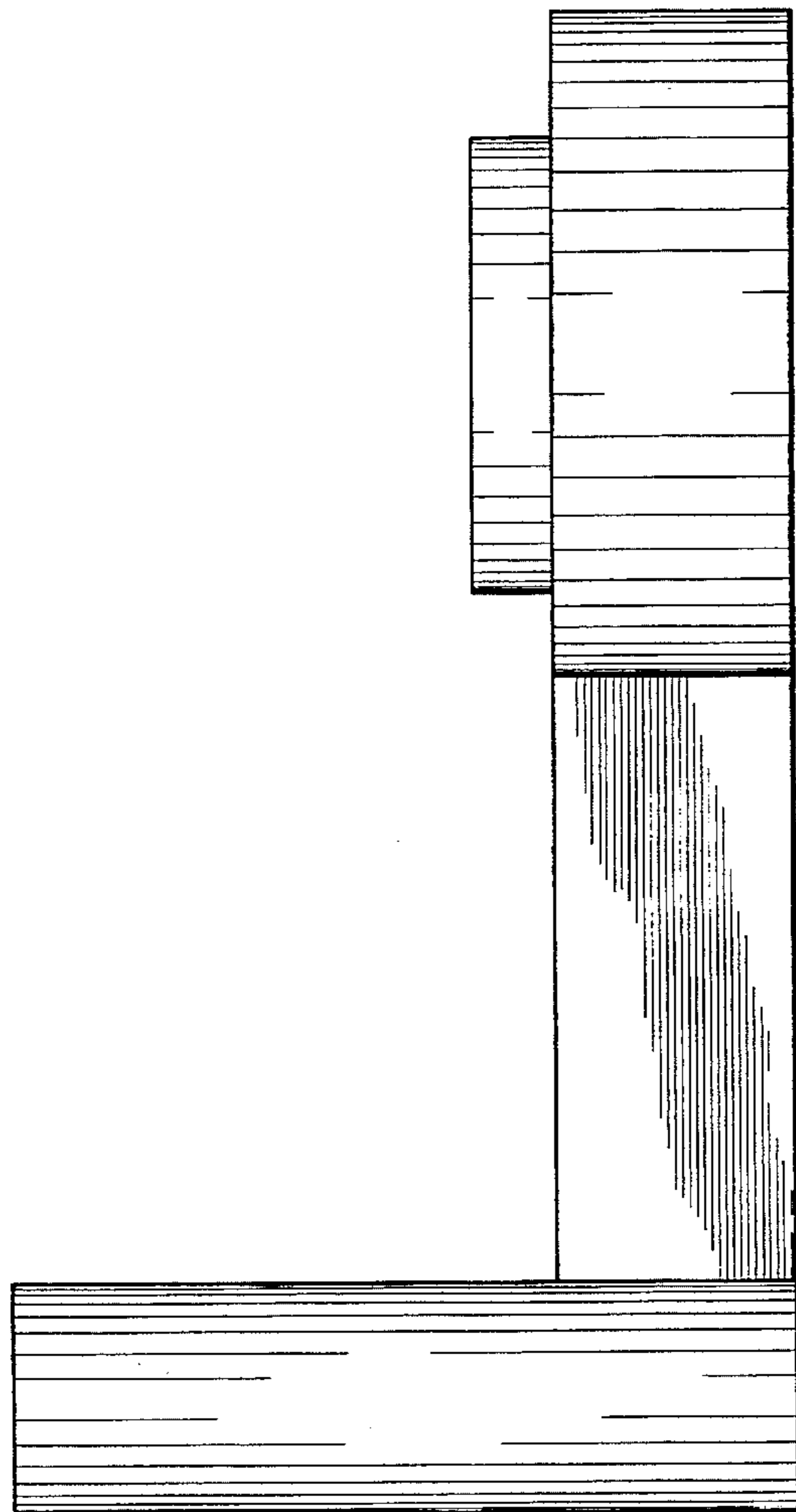

FIG. 7

