



US00D366046S

# United States Patent [19]

[11] Patent Number: **Des. 366,046**

Oba et al.

[45] Date of Patent: **\*\*Jan. 9, 1996**

[54] **AM/FM POWERED ANTENNA**

D. 345,362 3/1994 Kadono et al. .... D14/230  
2,947,989 8/1960 Ford et al. .... 343/757

[75] Inventors: **Haruo Oba; Eduardo Sciammarella,**  
both of Hoboken, N.J.

*Primary Examiner*—Dominic Simone  
*Attorney, Agent, or Firm*—Jay H. Maioli

[73] Assignee: **Sony Electronics Inc.,** Park Ridge, N.J.

[57] **CLAIM**

[\*\*] Term: **14 Years**

The ornamental design for an AM/FM powered antenna, as shown and described.

[21] Appl. No.: **17,405**

**DESCRIPTION**

[22] Filed: **Jan. 12, 1994**

[52] U.S. Cl. .... **D14/230**

[58] Field of Search ..... D14/230, 231;  
343/700 R, 757, 761, 781

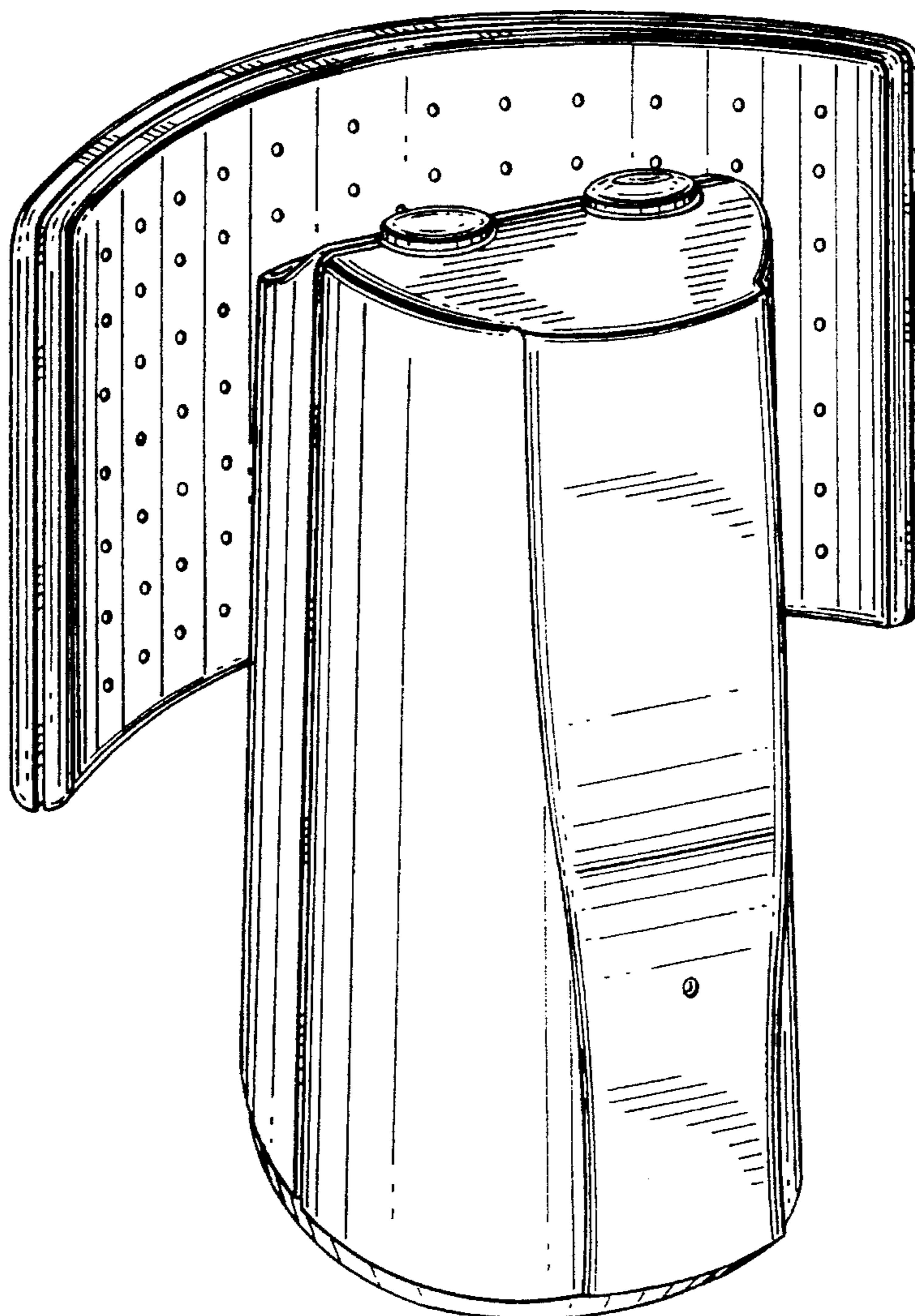
FIG. 1 is a top, front and left-side perspective view of an AM/FM powered antenna, showing our new design;  
FIG. 2 is a front elevational view thereof;  
FIG. 3 is a rear elevational view thereof;  
FIG. 4 is a right-side elevational view thereof;  
FIG. 5 is a left-side elevational view thereof;  
FIG. 6 is a top plan view thereof; and,  
FIG. 7 is a bottom plan view thereof.

[56] **References Cited**

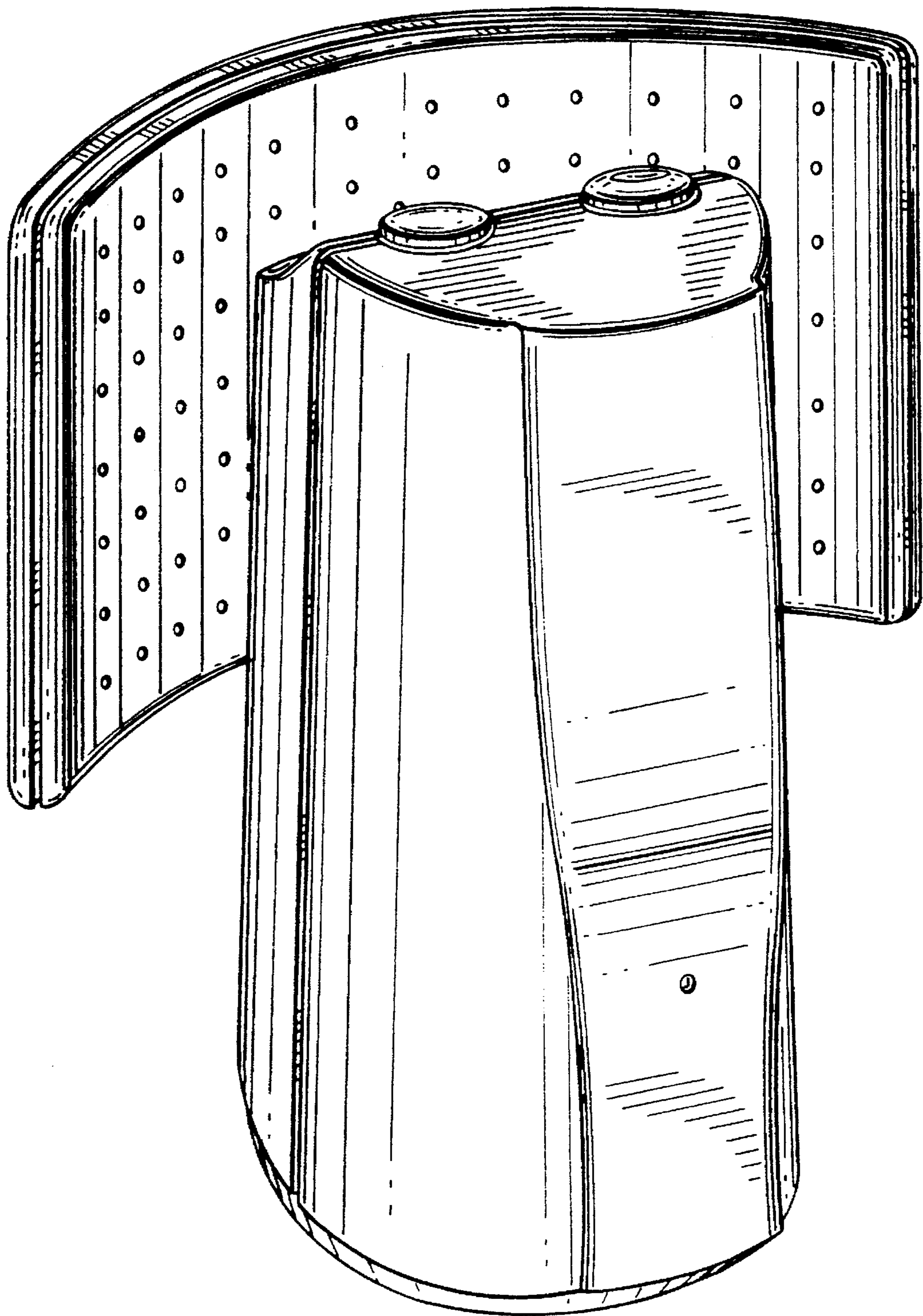
**U.S. PATENT DOCUMENTS**

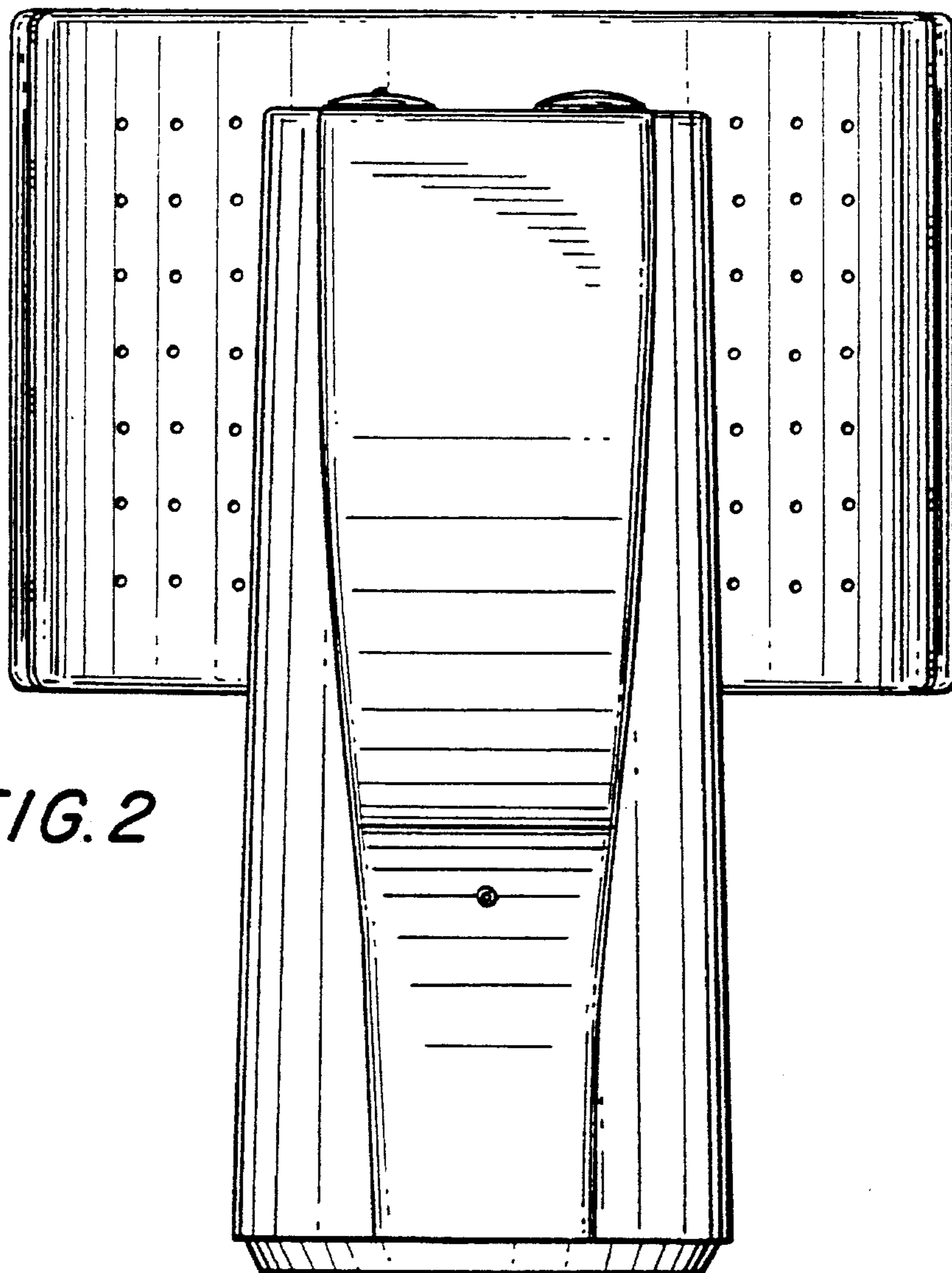
D. 158,177	4/1950	Christianson	.....	D14/230
D. 275,673	9/1984	Iino	.....	D14/230
D. 327,691	7/1992	Ogawa et al.	.....	D14/230
D. 333,471	2/1993	Vong	.....	D14/230

**1 Claim, 4 Drawing Sheets**

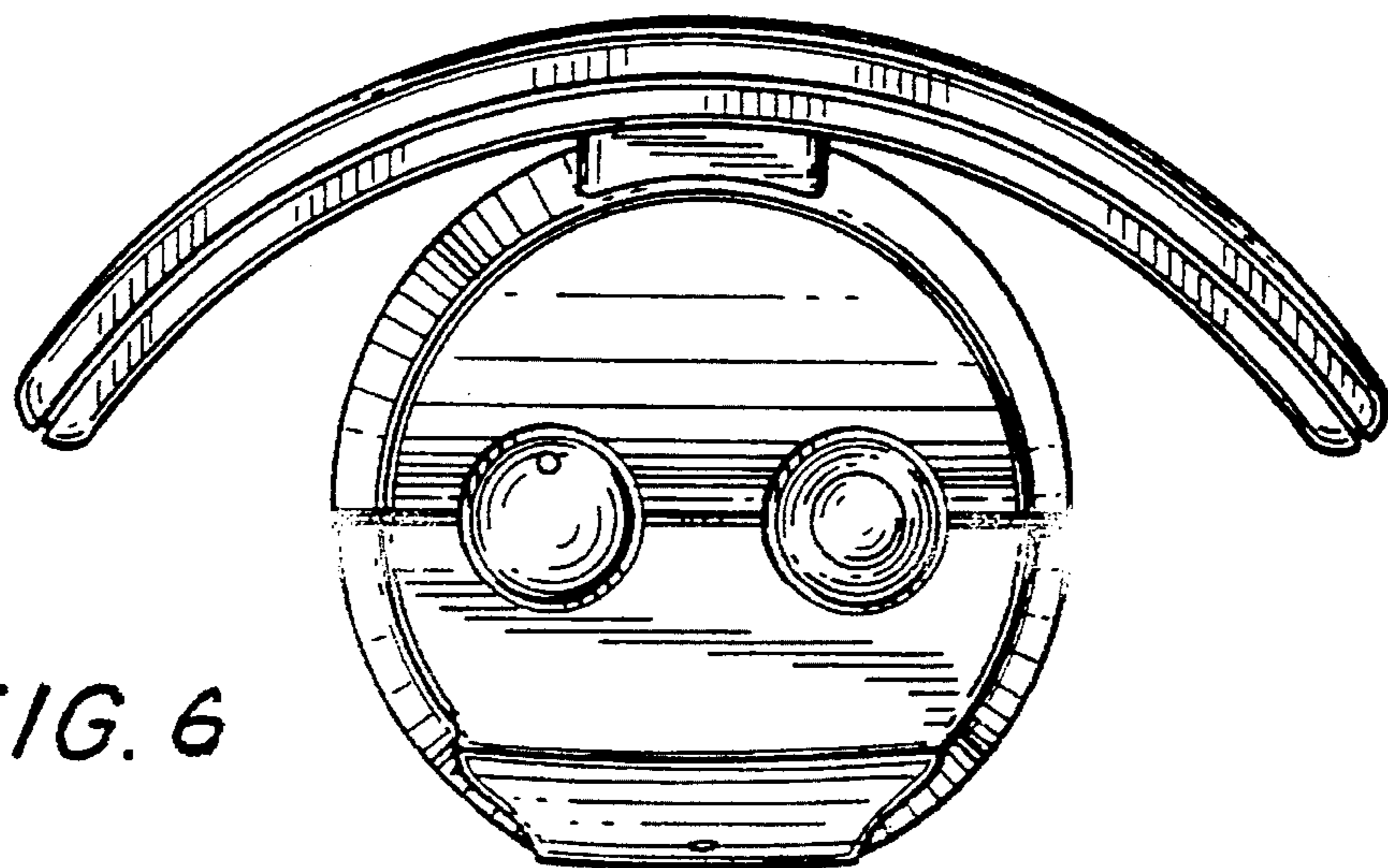


*FIG. 1*

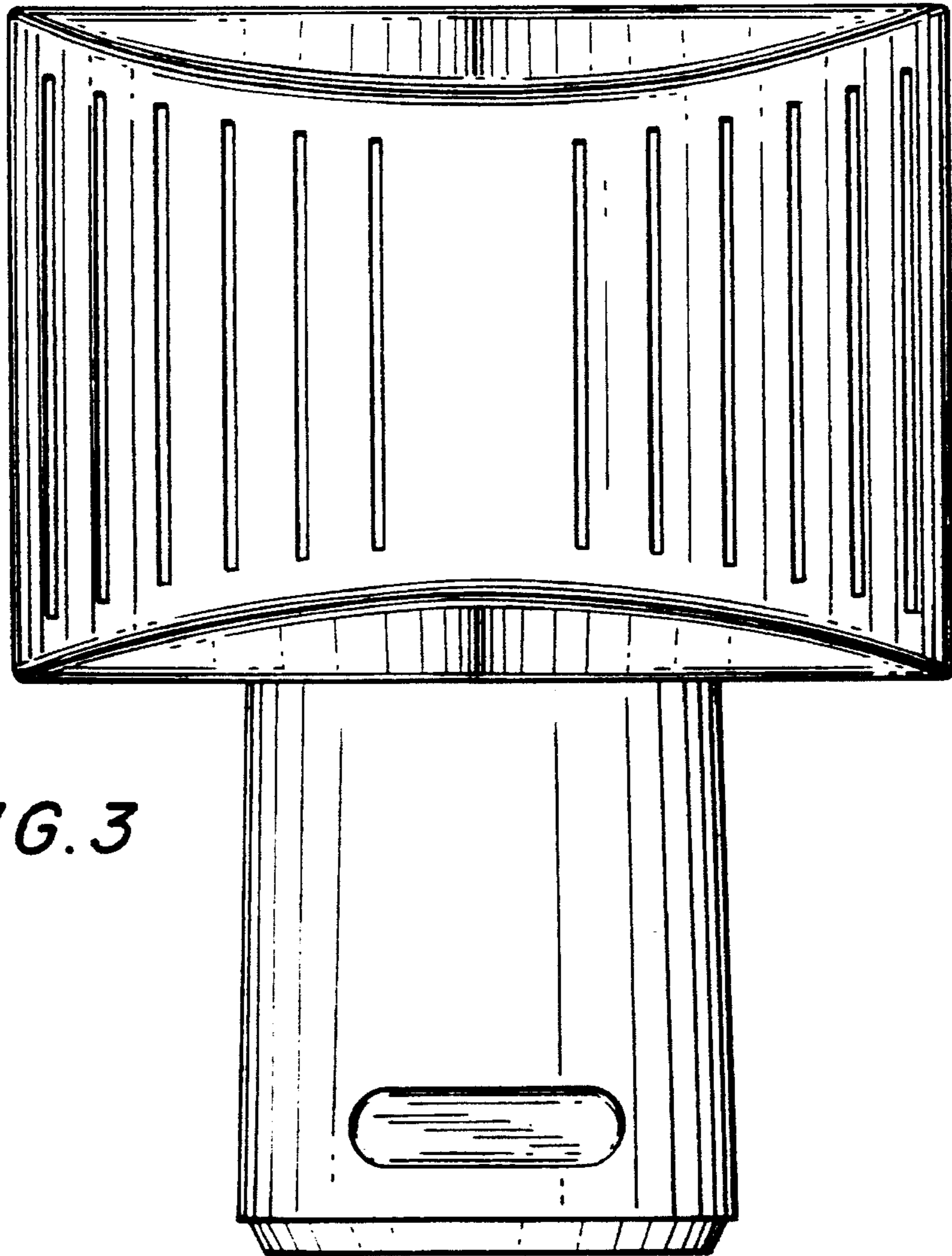




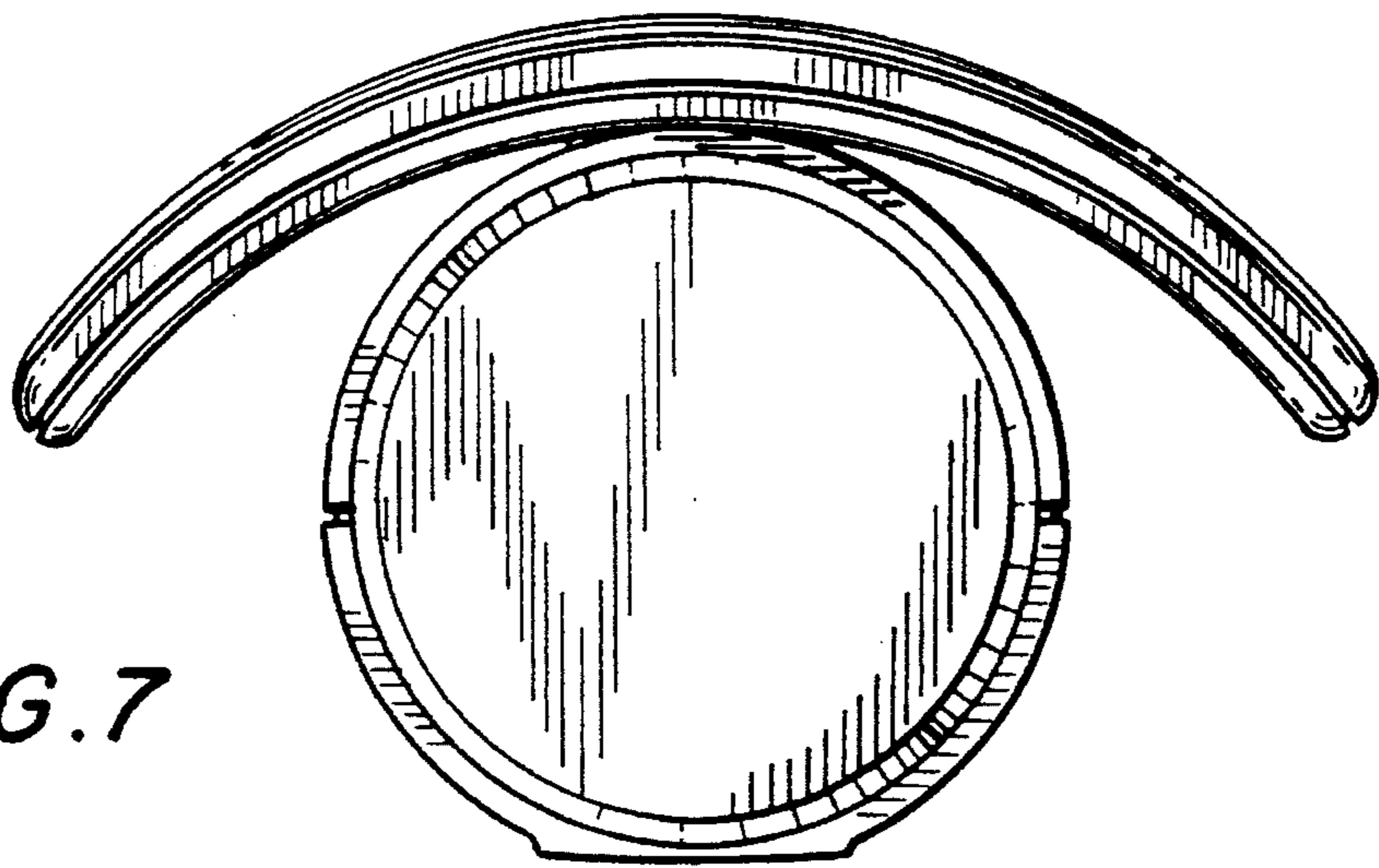
*FIG. 2*



*FIG. 6*



*FIG. 3*



*FIG. 7*

FIG. 5

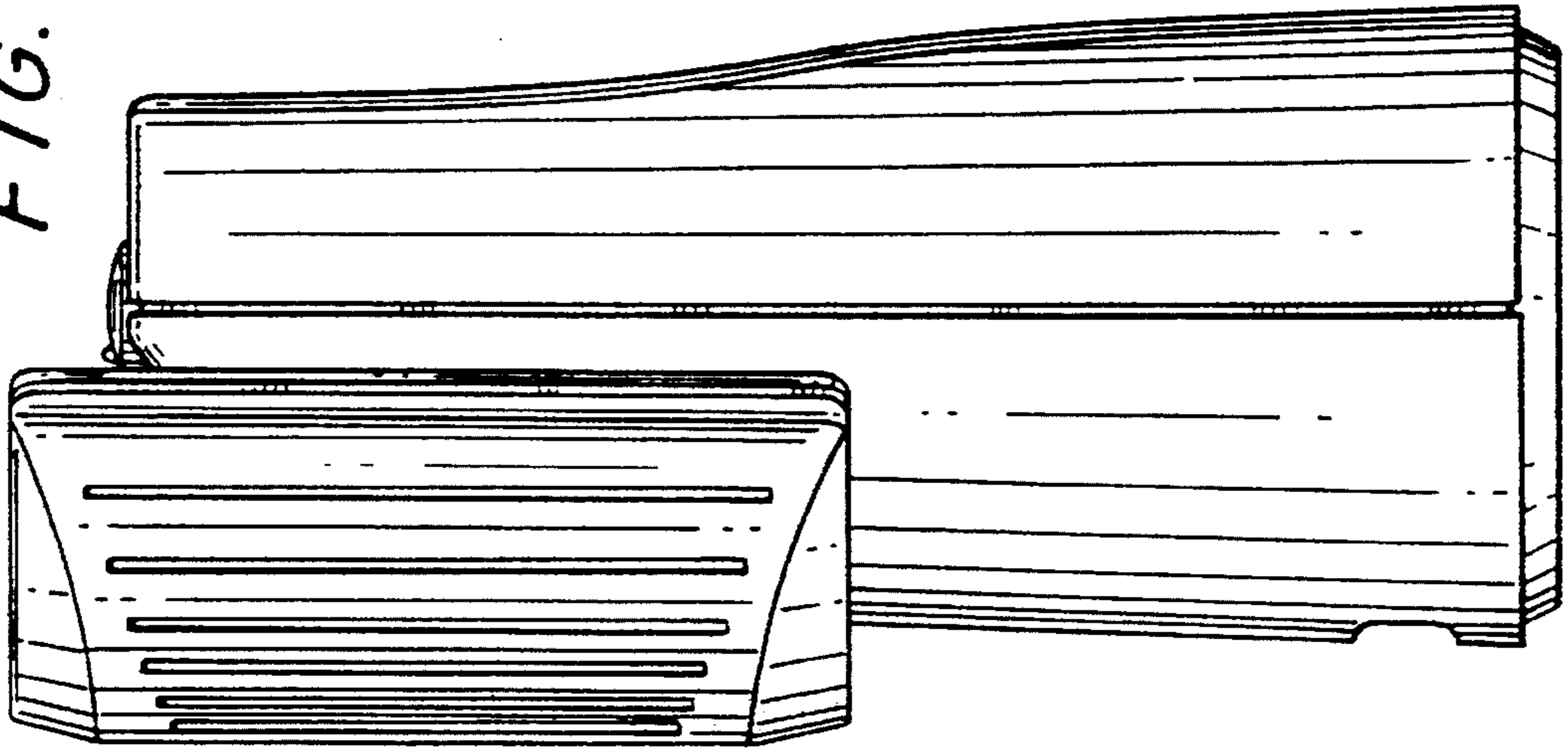


FIG. 4

