



US00D366039S

United States Patent [19]

Bailey et al.

[11] Patent Number: **Des. 366,039**

[45] Date of Patent: ****Jan. 9, 1996**

[54] **VIDEOCASSETTE**

[75] Inventors: **John A. Bailey**, Woodbury; **Glenn A. Bloomer**, Maplewood; **Gregory H. Johnson**, Oakdale, all of Minn.; **Nicholas A. Brawne**, Columbus, Ohio; **Mark J. Ciesko**, Hilliard, Ohio; **Donald J. Staufenberg**, Dublin, Ohio

[73] Assignee: **Minnesota Mining and Manufacturing Company**, St. Paul, Minn.

[**] Term: **14 Years**

[21] Appl. No.: **20,931**

[22] Filed: **Apr. 5, 1994**

[52] U.S. Cl. **D14/121**

[58] Field of Search D14/120-123, D14/299; 206/387.1, 387.12-387.15; 242/342-345, 345.1-345.3, 346, 346.2; 360/132

[56] **References Cited**

U.S. PATENT DOCUMENTS

- D. 266,419 10/1982 Hashimoto et al. D14/121
- D. 351,379 10/1994 Suzuki D14/121

- 4,501,396 2/1985 Tomsyck et al. 242/199
- 4,754,357 6/1988 Nelson 360/132
- 4,858,848 8/1989 Katoku et al. 242/346.2 X
- 4,911,298 3/1990 Miyagawa et al. 206/387.1

Primary Examiner—Ted Shooman
Assistant Examiner—Nanda Bondade
Attorney, Agent, or Firm—Gary L. Griswold; Walter N. Kim; Charles D. Levine

[57] **CLAIM**

The ornamental design for a videocassette, as shown and described.

DESCRIPTION

FIG. 1 is a perspective view of a videocassette showing our new design;
FIG. 2 is a front view thereof;
FIG. 3 is a rear view thereof;
FIG. 4 is a top view thereof;
FIG. 5 is a bottom view thereof;
FIG. 6 is a right side view thereof; and,
FIG. 7 is a left side view thereof.

The broken line showing of the tape reel is for illustrative purposes only and forms no part of the claimed design.

1 Claim, 3 Drawing Sheets

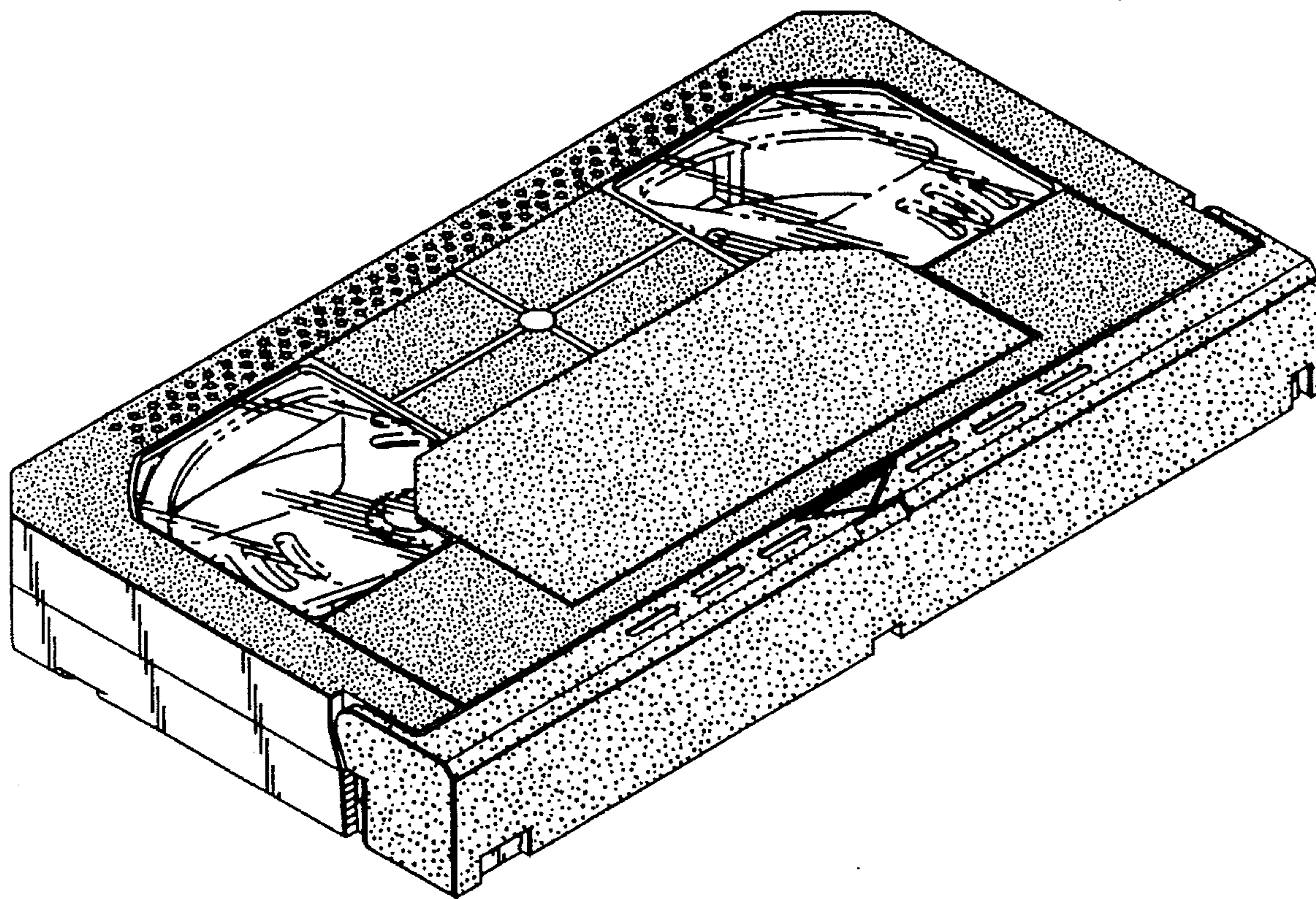

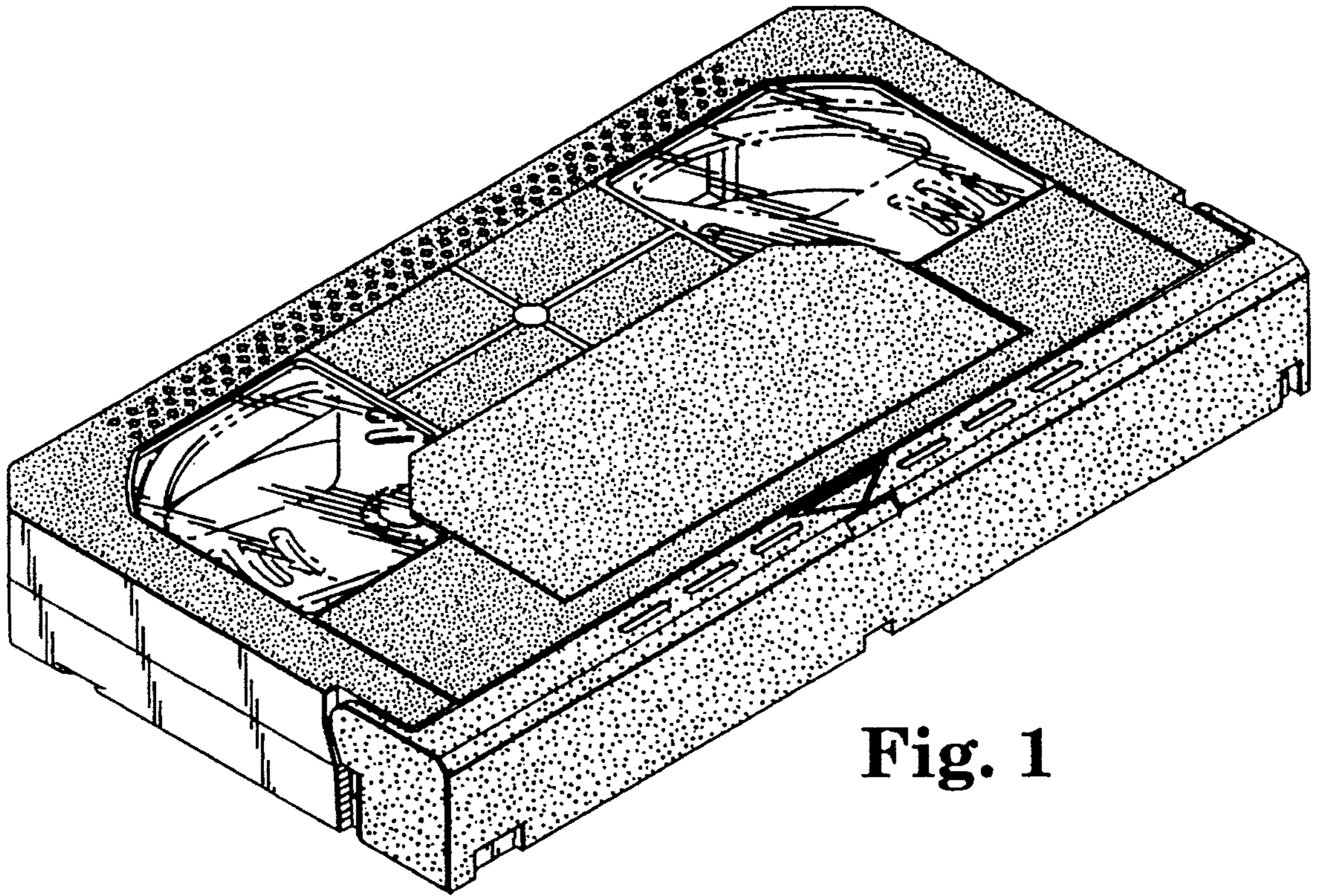

Fig. 1

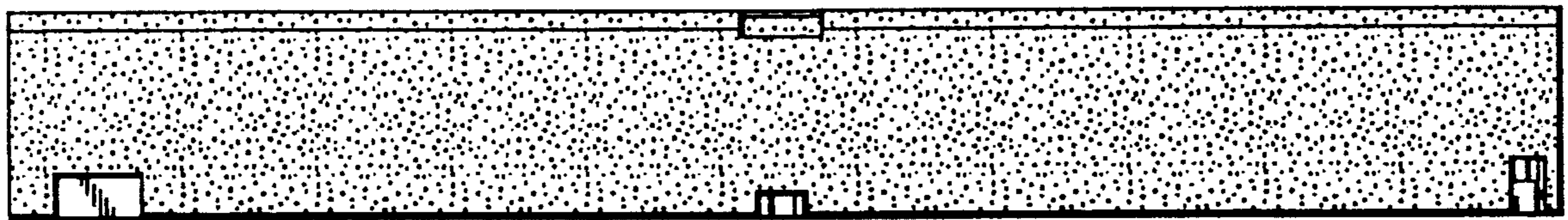

Fig. 2

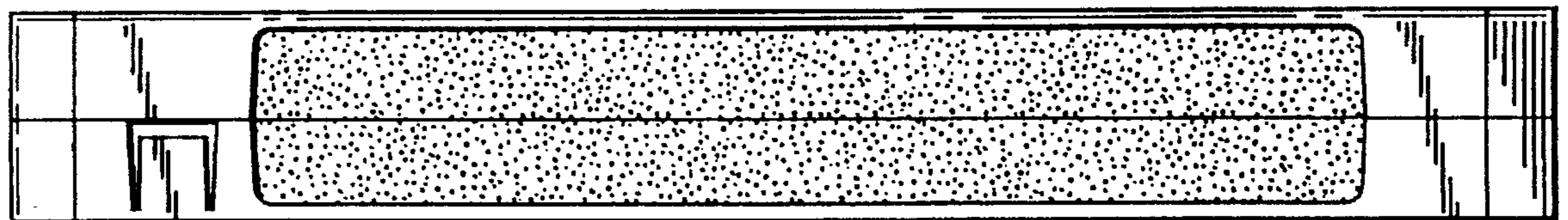

Fig. 3

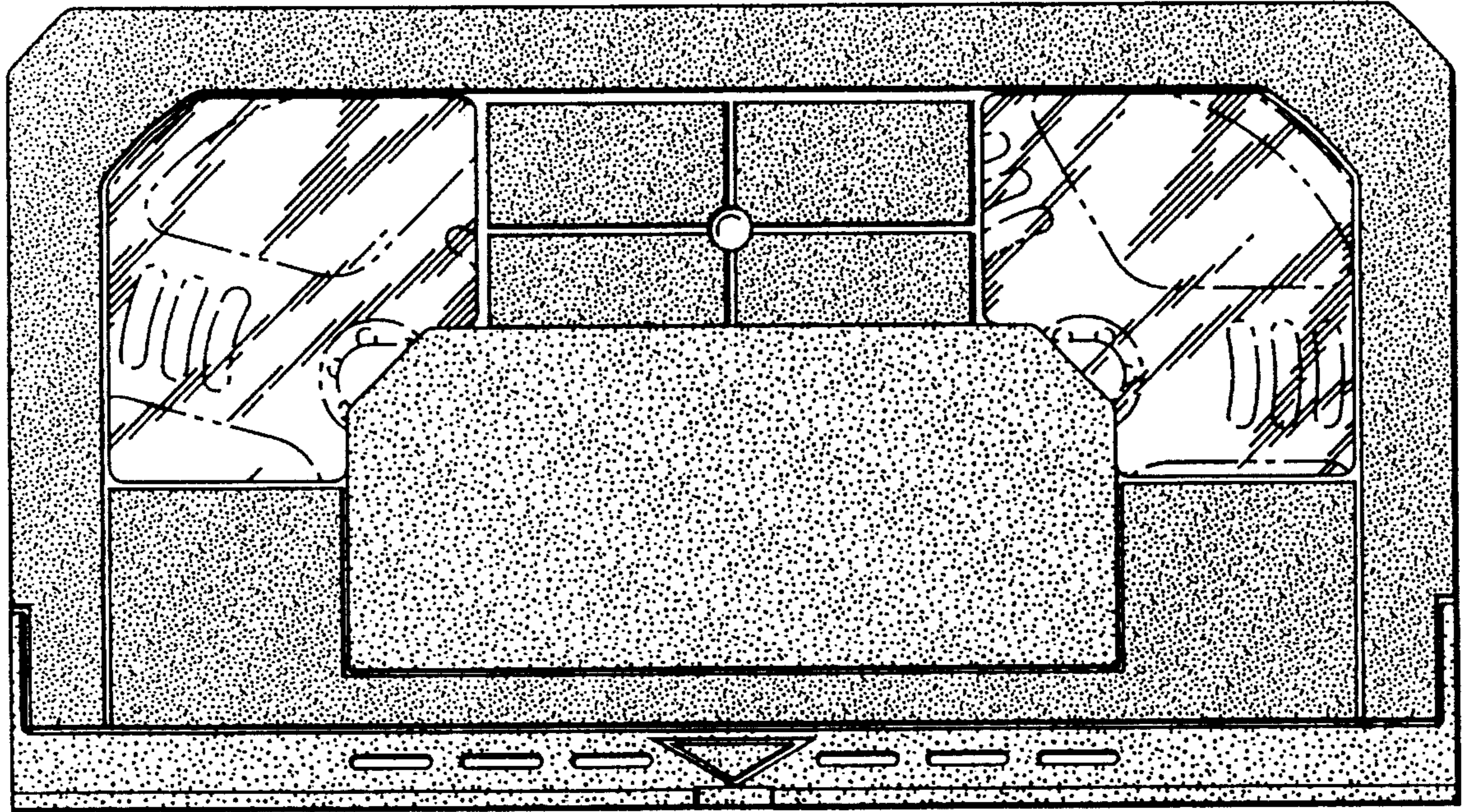

Fig. 4

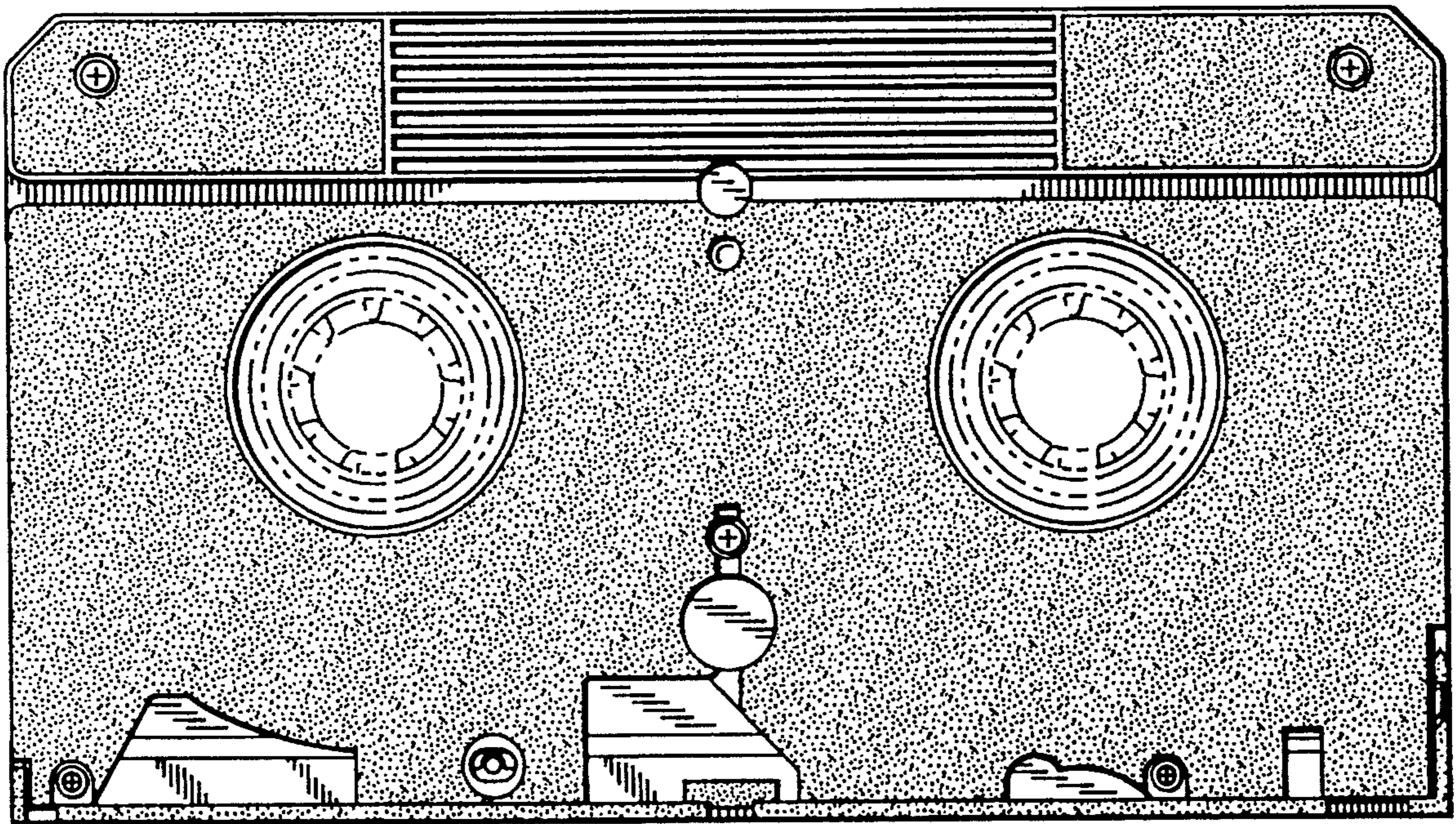

Fig. 5



Fig. 6

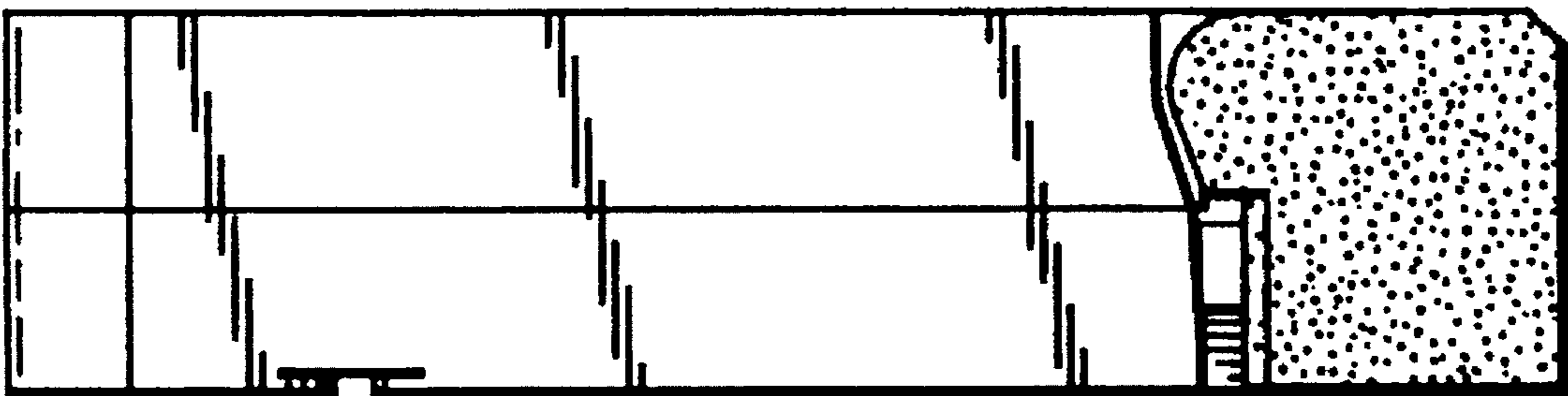

Fig. 7