



US00D365991S

# United States Patent [19]

[11] Patent Number: **Des. 365,991**

**Varlet**

[45] Date of Patent: **\*\*Jan. 9, 1996**

[54] **COMBINED PERFUME BOTTLE AND CLOSURE**

*Primary Examiner*—Lucy Lieberman  
*Attorney, Agent, or Firm*—Lowe, Price, LeBlanc & Becker

[75] Inventor: **Hubert Varlet**, Paris, France

[57] **CLAIM**

[73] Assignee: **Verreries Pochet et du Courval**, Paris, France

The ornamental design for combined perfume bottle and closure, as shown and described.

[\*\*] Term: **14 Years**

**DESCRIPTION**

[21] Appl. No.: **14,936**

FIG. 1 is a front elevation of the perfume bottle shown without the closure for clarity of illustration, the rear elevation is the same;

[22] Filed: **Nov. 4, 1993**

FIG. 2 is a side elevation thereof, the opposite side is the same;

[30] **Foreign Application Priority Data**

May 5, 1993 [FR] France ..... 932422

FIG. 3 is a top view thereof;

[52] **U.S. Cl.** ..... **D9/544; D9/573**

FIG. 4 is a perspective view thereof;

[58] **Field of Search** ..... D9/544, 573, 439, D9/574; 215/1 R, 1 C

FIG. 5 is a bottom view thereof;

FIG. 6 is a front elevation of the combined perfume bottle and closure, the rear elevation is the same;

[56] **References Cited**

**U.S. PATENT DOCUMENTS**

- D. 60,098 12/1921 Kammer ..... D9/544
- D. 86,724 4/1932 Joseph ..... D9/544 X
- D. 149,950 6/1948 Klebanoff ..... D9/544
- D. 202,383 9/1965 DuPree ..... D9/544
- D. 333,619 3/1993 Lemahieu ..... D9/544 X

FIG. 7 is a side elevation of the combined perfume bottle and closure, the opposite side elevation is the same; and,

FIG. 8 is a top view of the combined perfume bottle and closure.

The bottle is shown without the closure in FIGS. 1-4 for clarity of illustration.

**1 Claim, 3 Drawing Sheets**

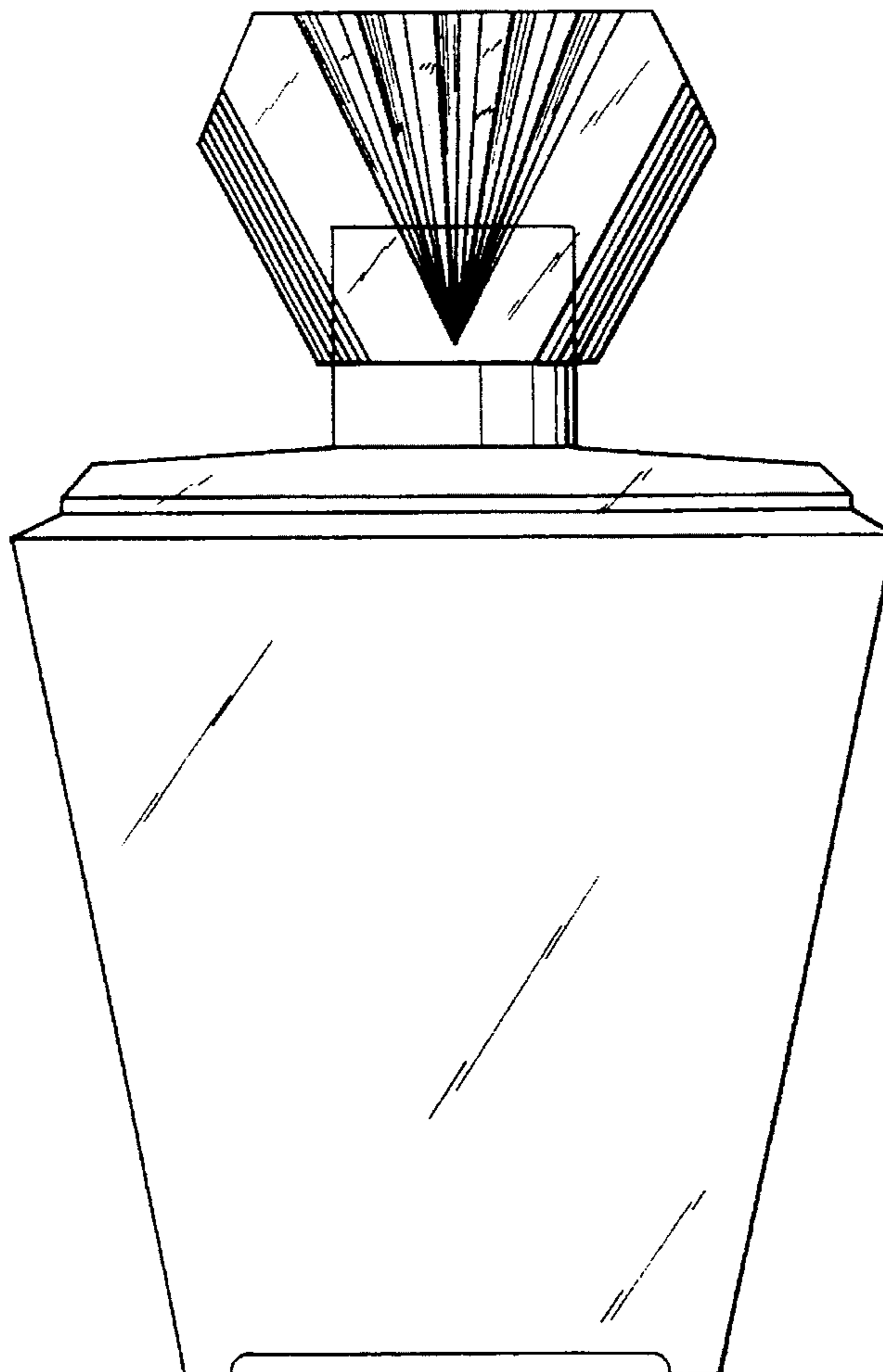

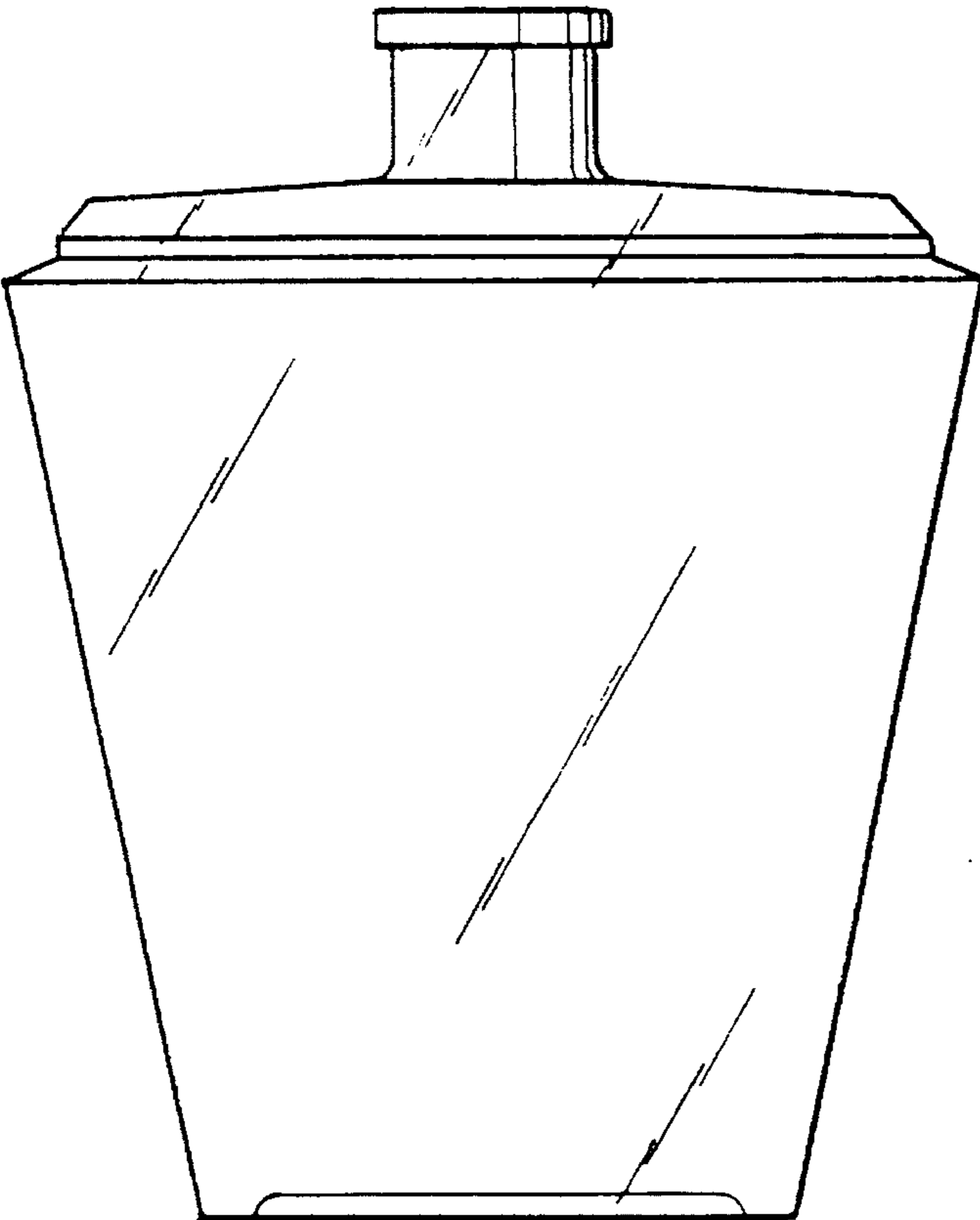

FIG. 1

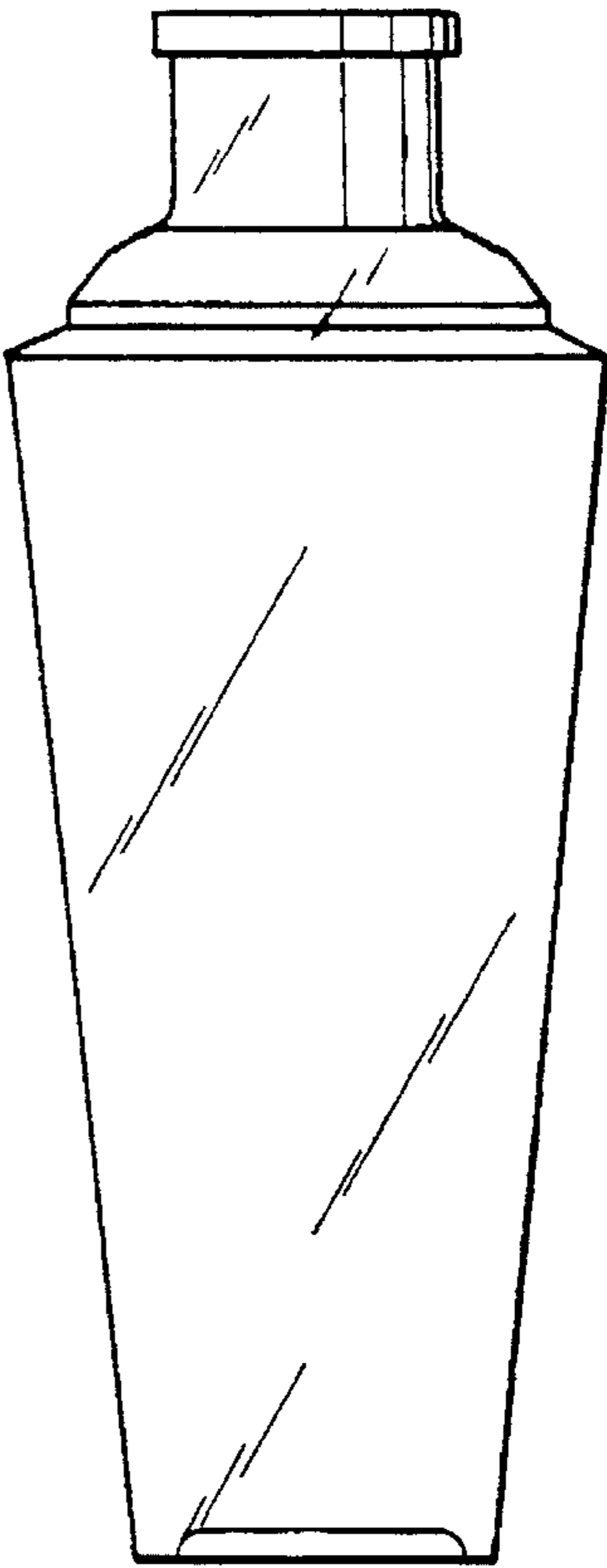

FIG. 2

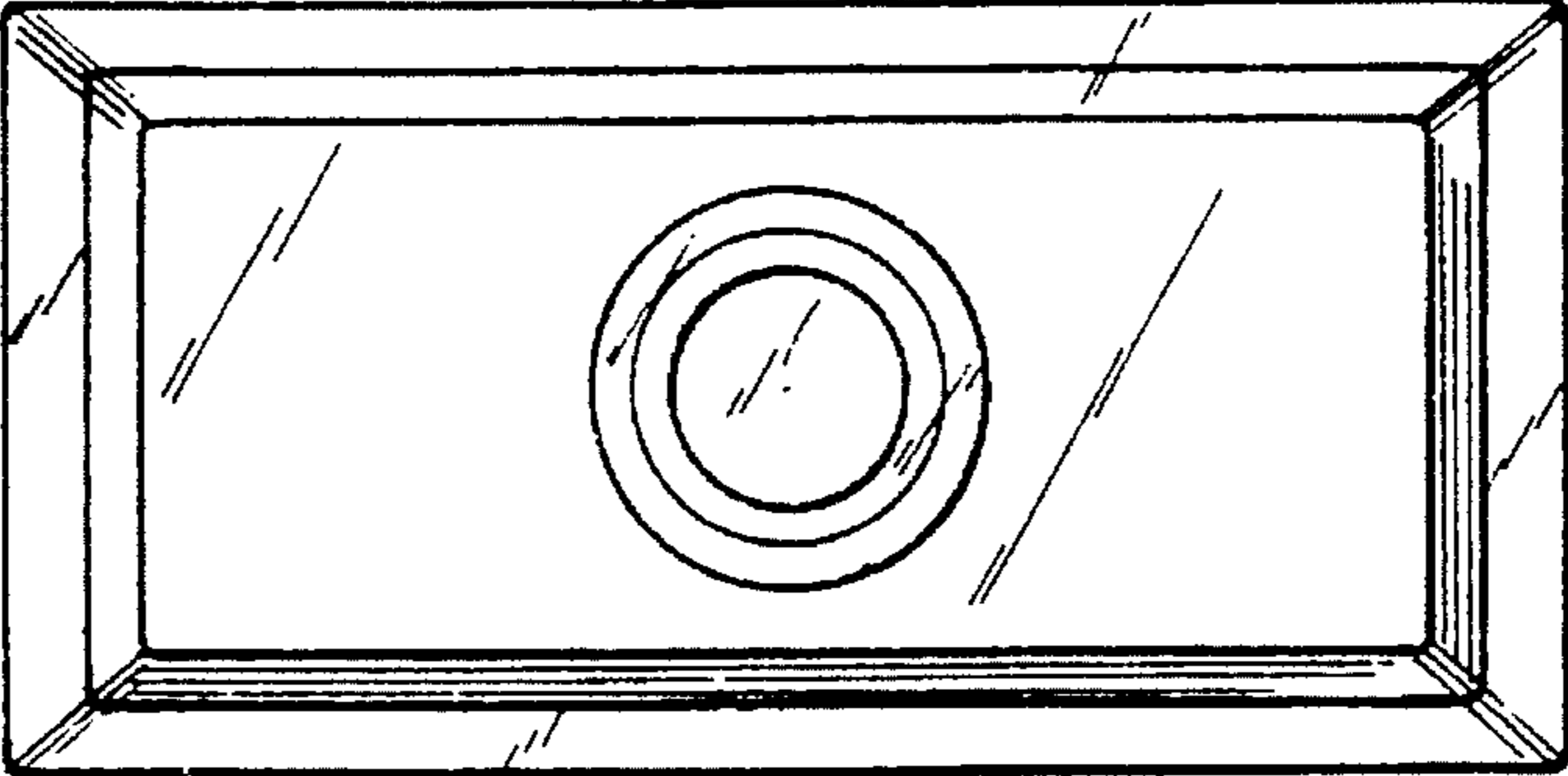

FIG. 3

FIG. 4

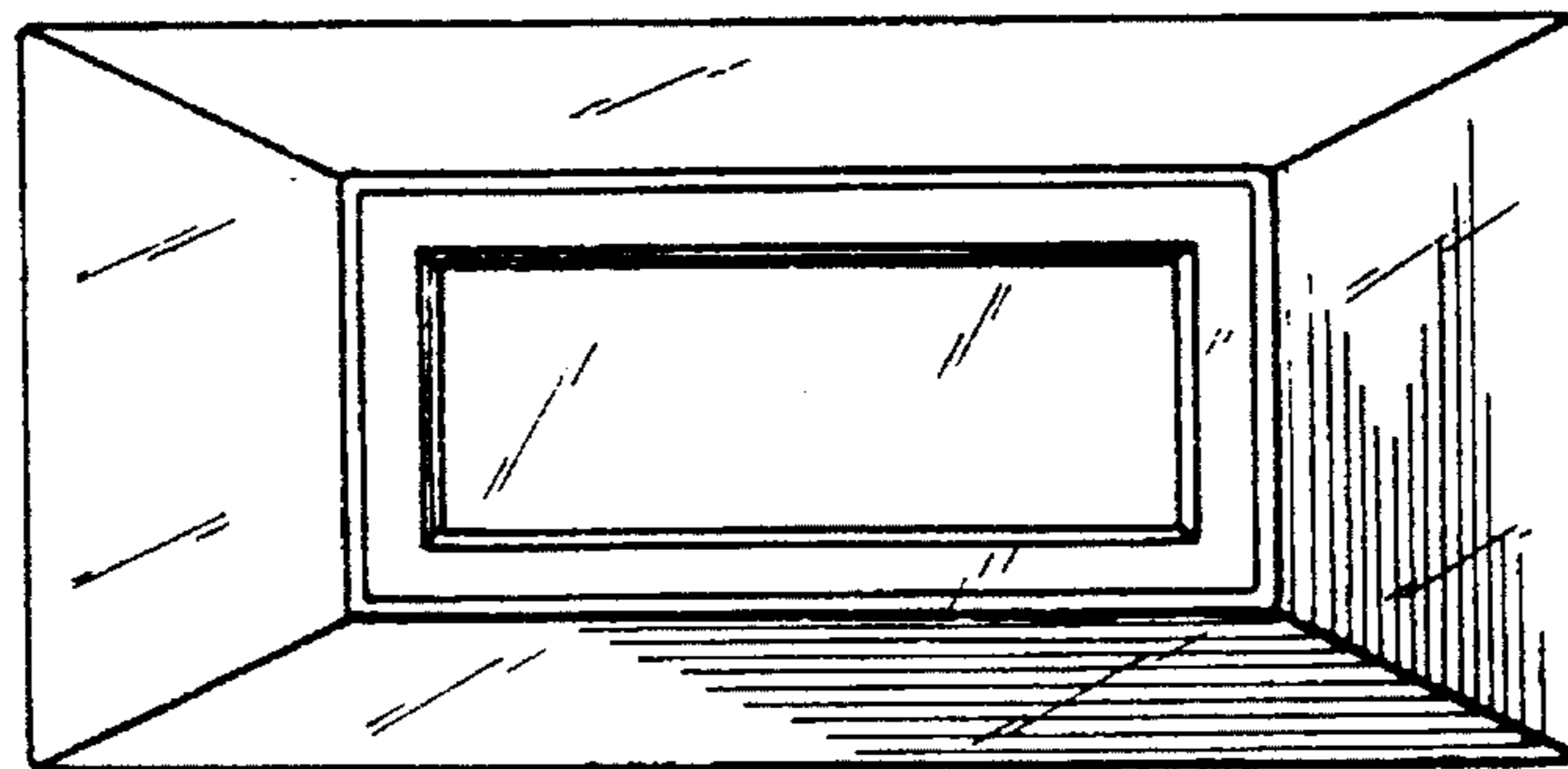
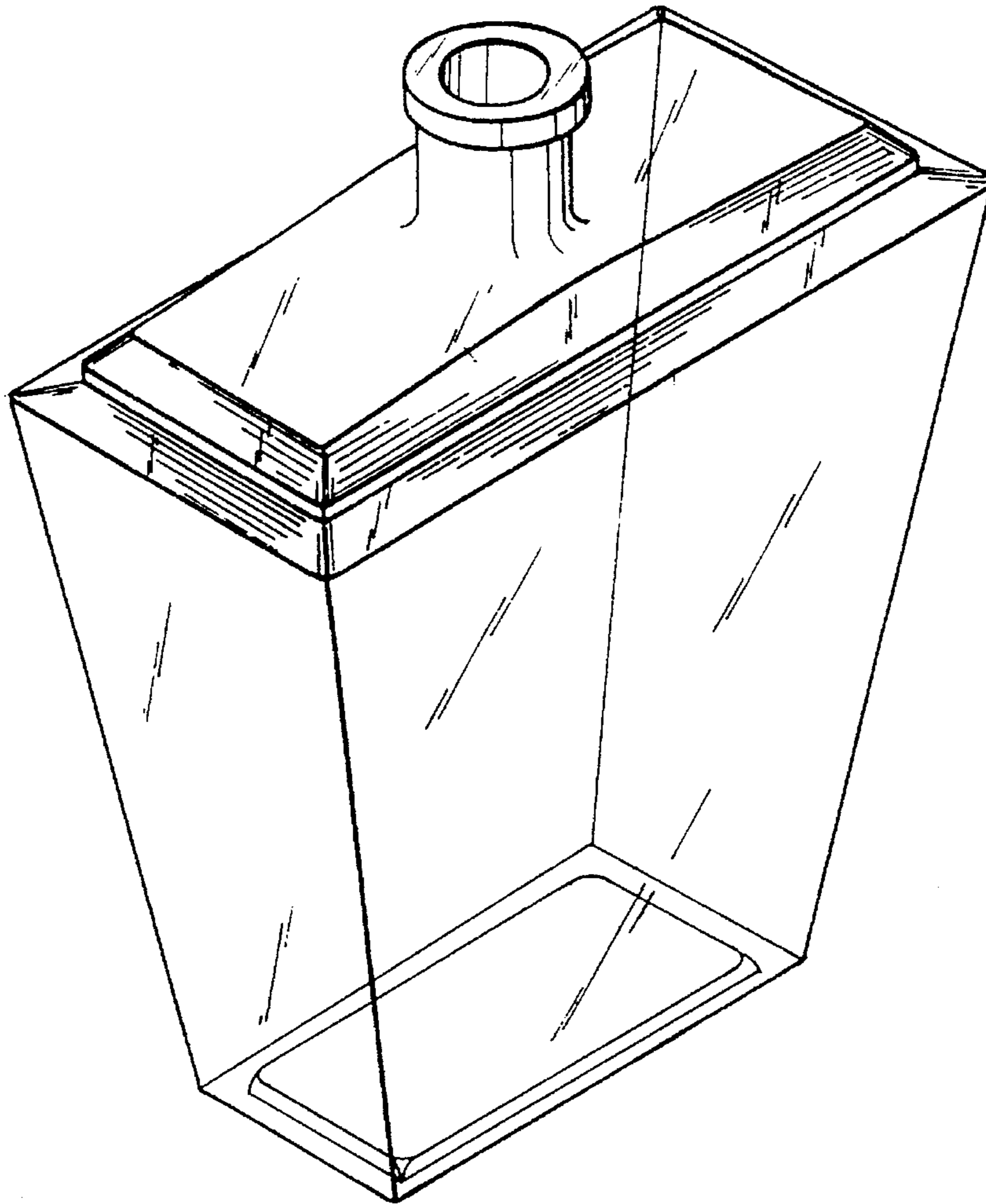

FIG. 5

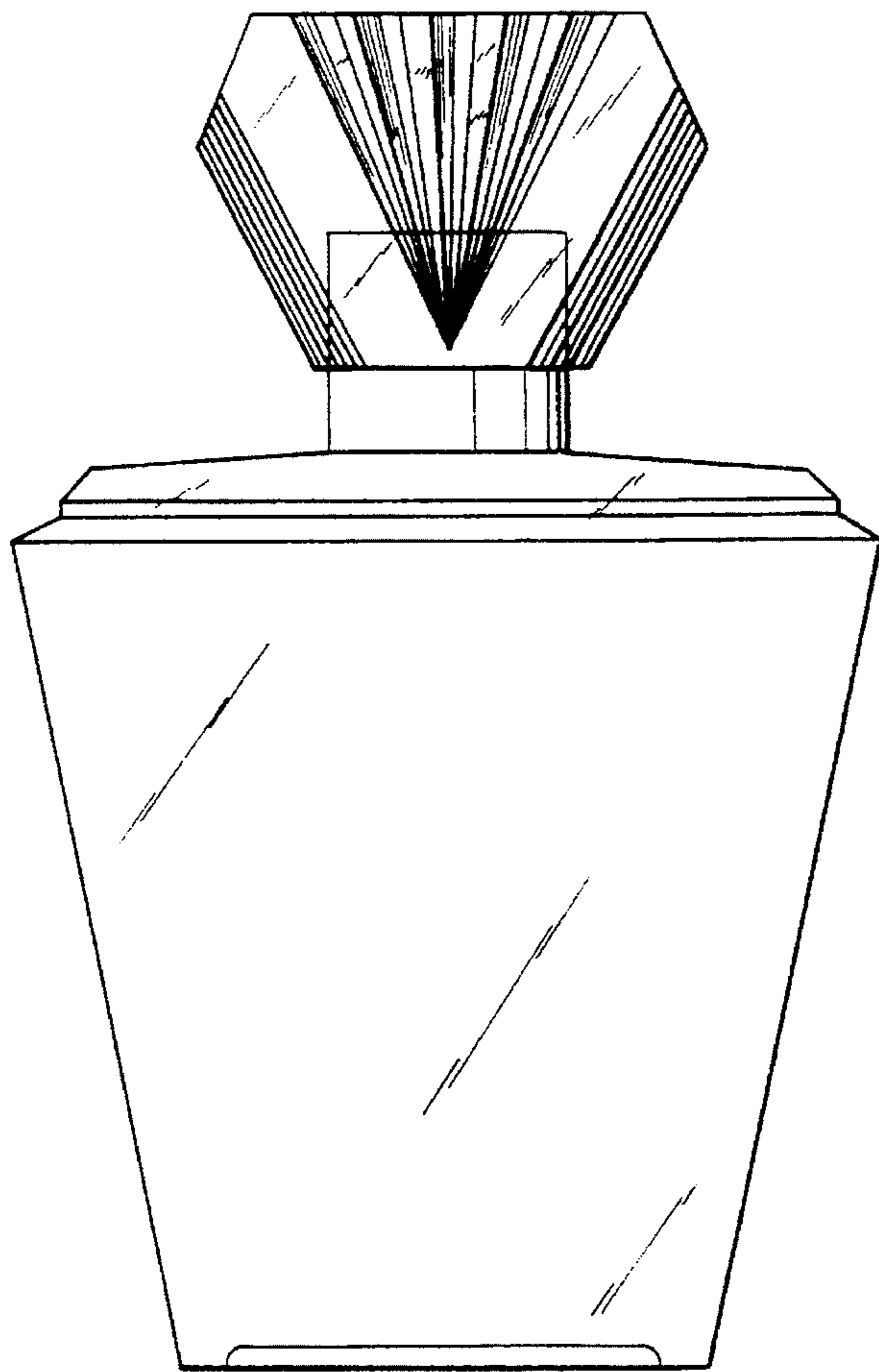

FIG. 6

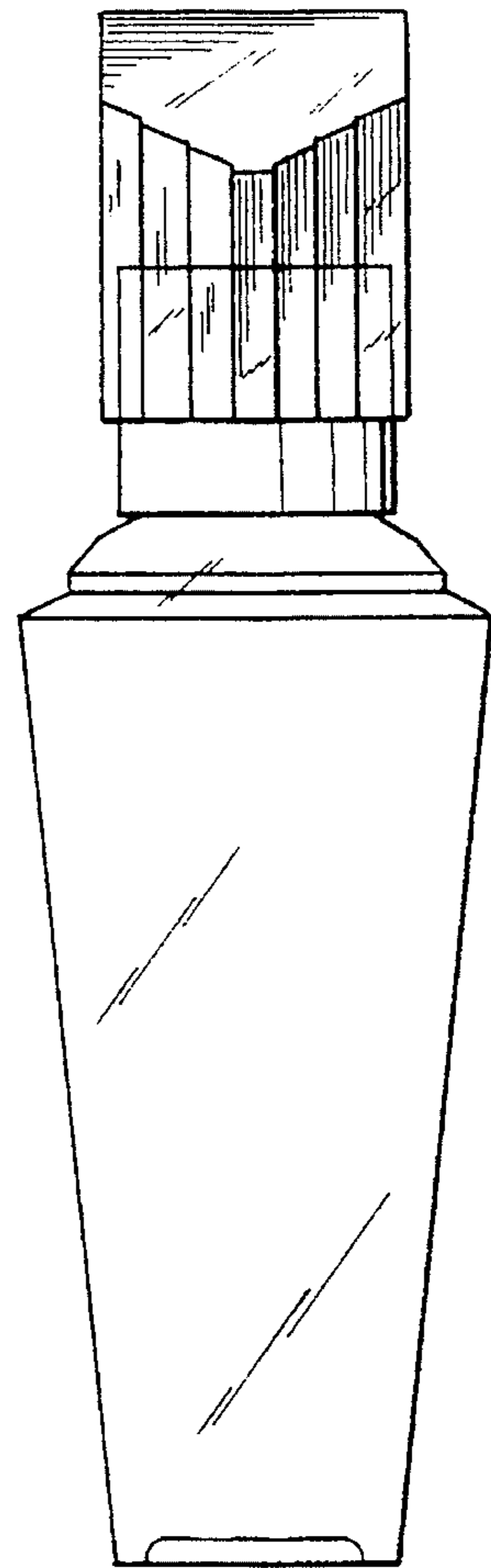

FIG. 7

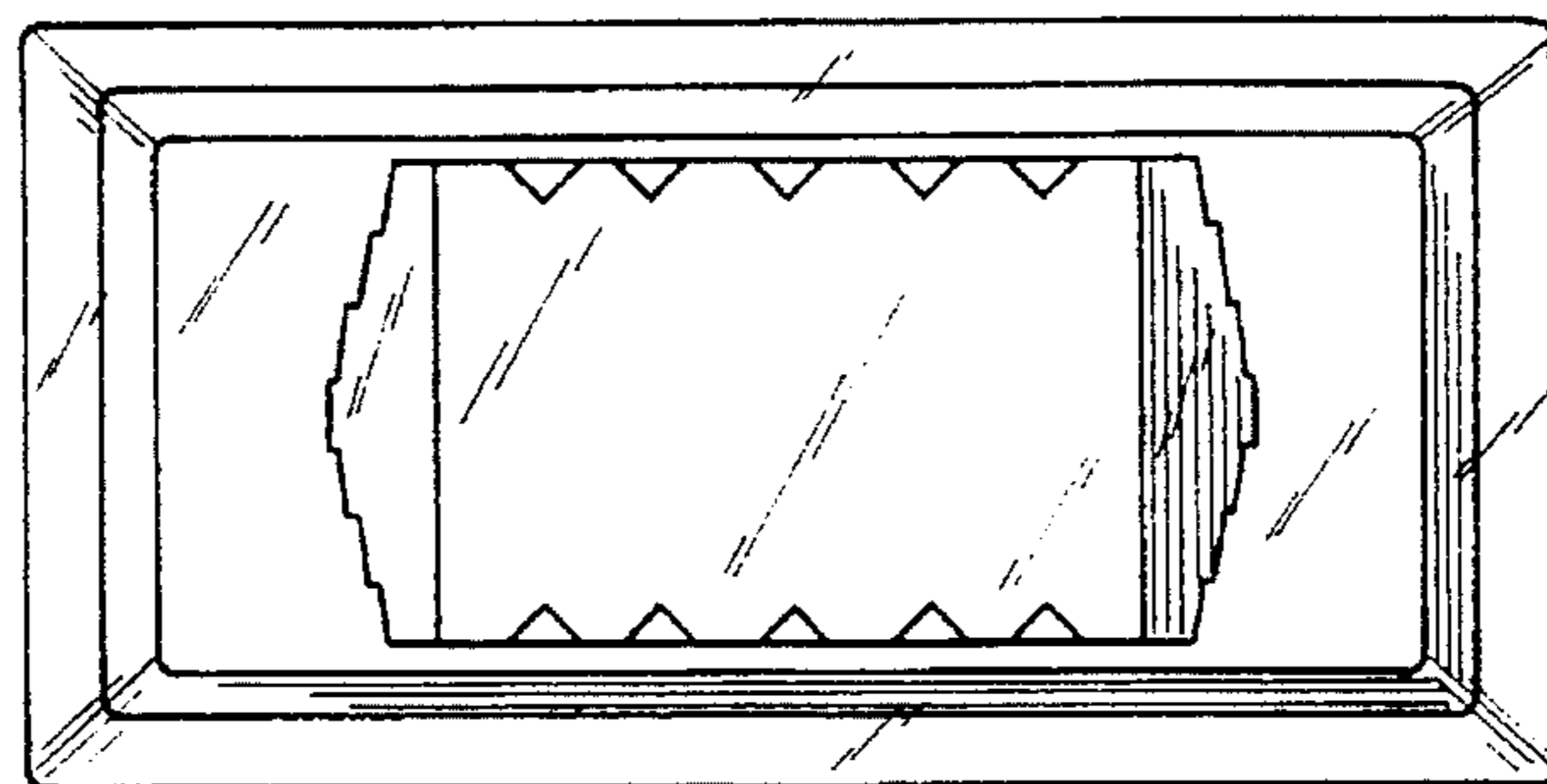

FIG. 8