



US00D365984S

United States Patent [19]

Hofmann

[11] Patent Number: **Des. 365,984**

[45] Date of Patent: ****Jan. 9, 1996**

[54] PACKAGING CONTAINER

[76] Inventor: **Michal Hofmann**, P.O. Box 28130, Auckland 1136, New Zealand

[**] Term: **14 Years**

[21] Appl. No.: **30,122**

[22] Filed: **Nov. 1, 1994**

[30] Foreign Application Priority Data

May 2, 1994 [NZ] New Zealand 25878

[52] U.S. Cl. **D9/415**; D9/420

[58] Field of Search D9/415, 418, 420-423, D9/341, 345, 346; 206/461-471, 45.31, 45.34, 45.28, 223, 806, 526; 220/337, 334

[56] References Cited

U.S. PATENT DOCUMENTS

D. 294,123	2/1988	Hill	D9/415
D. 305,733	1/1990	Ferris	D9/415
4,619,364	10/1986	Czopor, Jr.	206/470 X
4,681,223	7/1987	Roberts	206/470 X
4,795,029	1/1989	Campbell et al.	206/470 X
4,869,364	9/1989	Bray	206/472 X
5,293,993	3/1994	Yates, Jr. et al.	206/470 X

OTHER PUBLICATIONS

Modern Packaging, 1941, p. 300.

Primary Examiner—Prabhakar G. Deshmukh
Attorney, Agent, or Firm—Young & Thompson

[57] CLAIM

The ornamental design for a packaging container, as shown and described.

DESCRIPTION

FIG. 1 : being a view from one end of the packaging container when it is open;

FIG. 2 : being a view from an opposite end of the container when it is open;

FIG. 3: being a view from one side of the container;

FIG. 4: being a view from an opposite side of the container;

FIG. 5: being a plan view of an inner face of the container when it is open;

FIG. 6: being a plan view of an outer face of the container when it is open; and,

FIG. 7: being a perspective view on the outer face of the container when it is open.

1 Claim, 3 Drawing Sheets

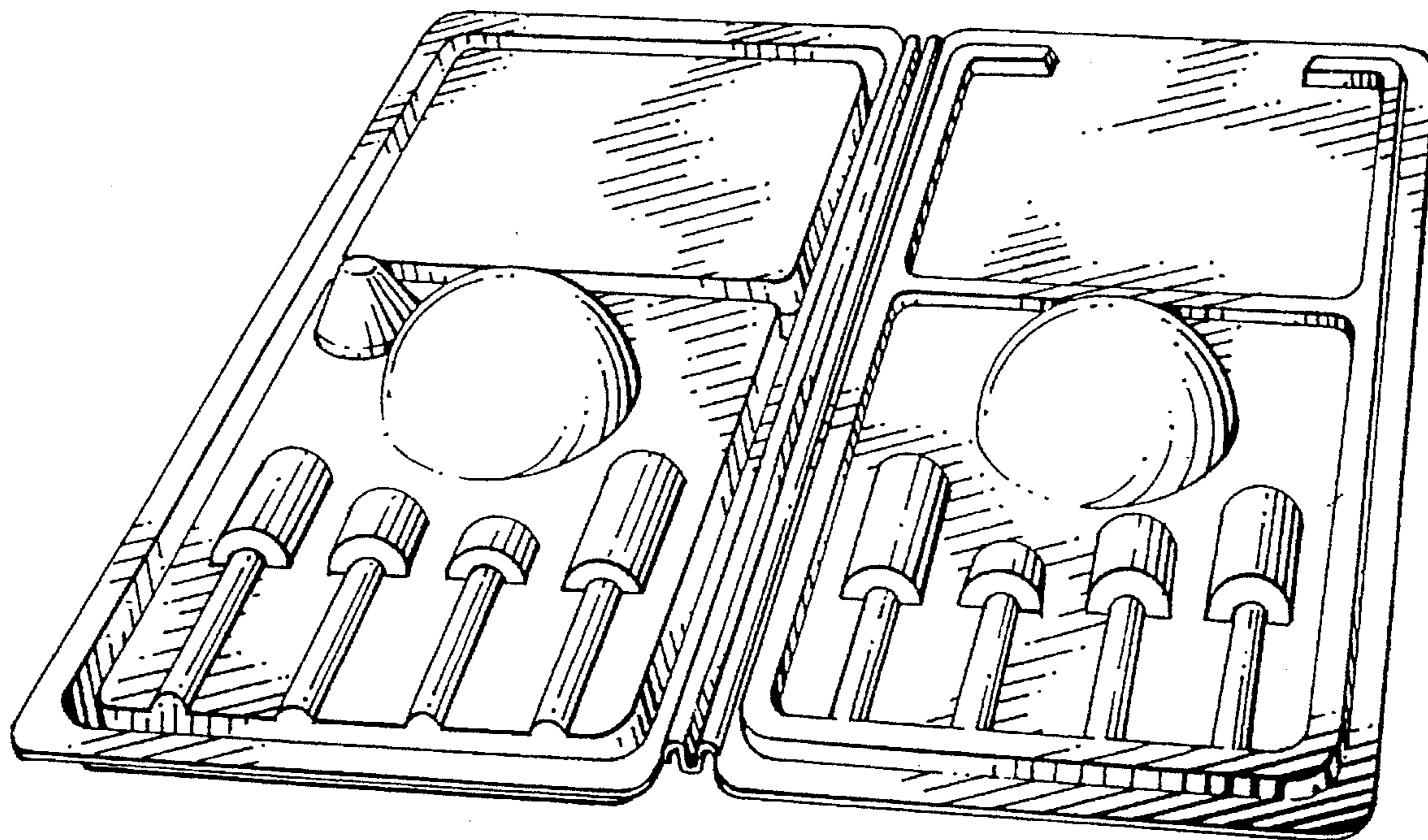

FIG. 1

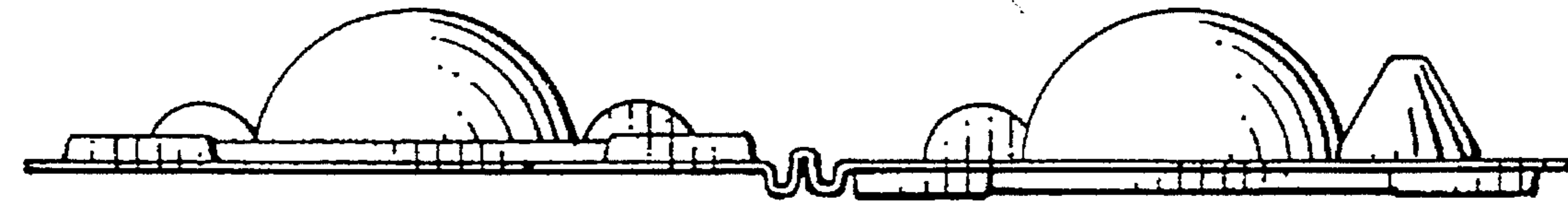
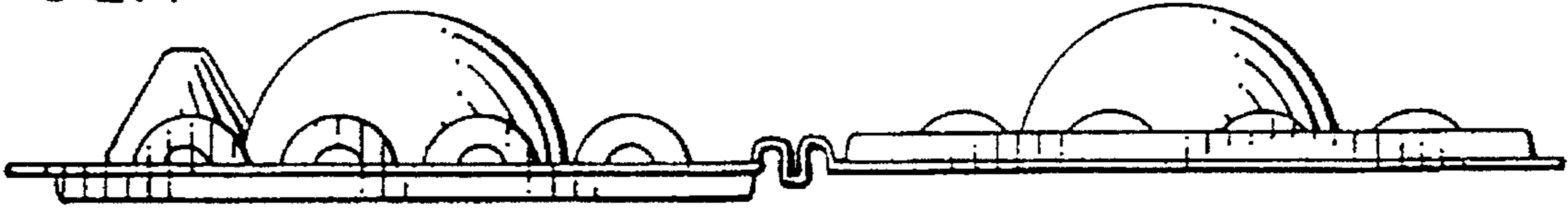

FIG. 2

FIG. 3

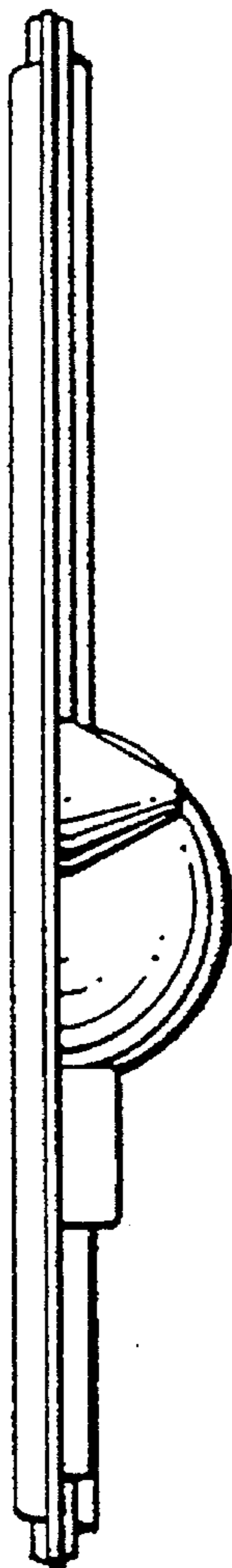

FIG. 4

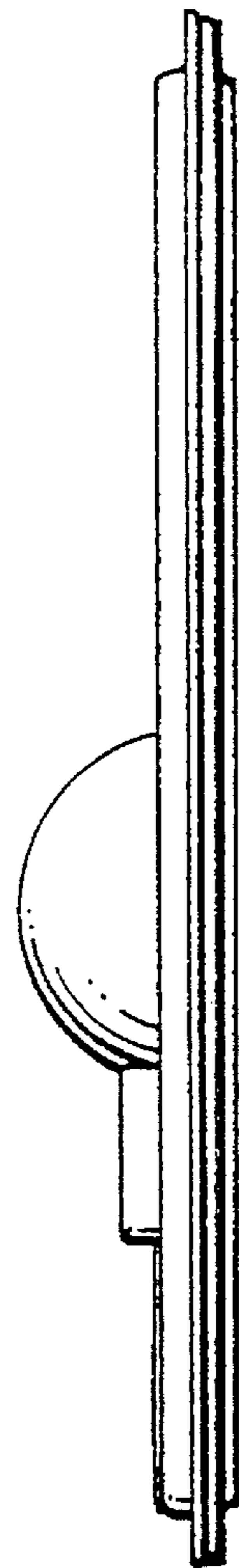

FIG. 5

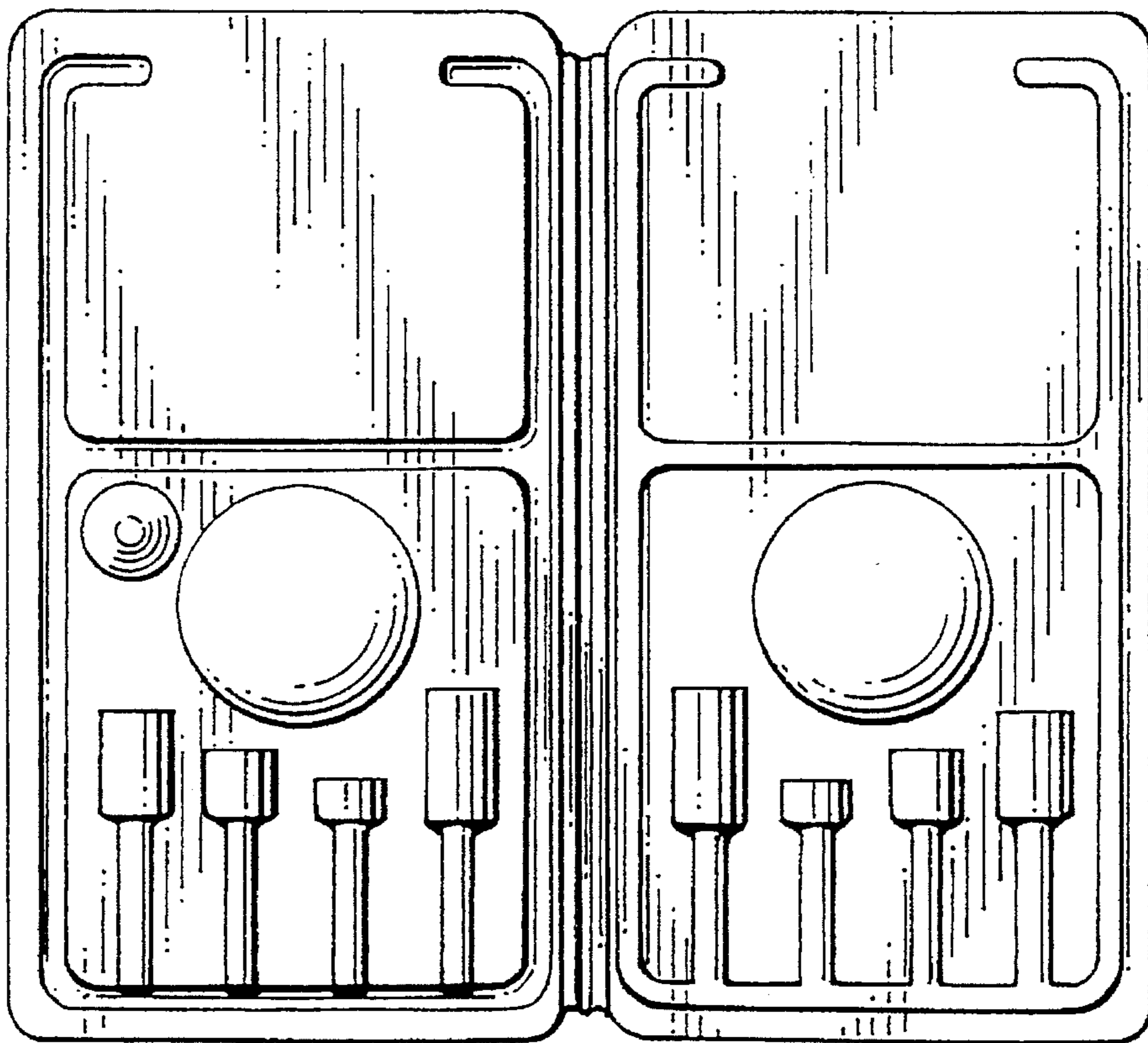
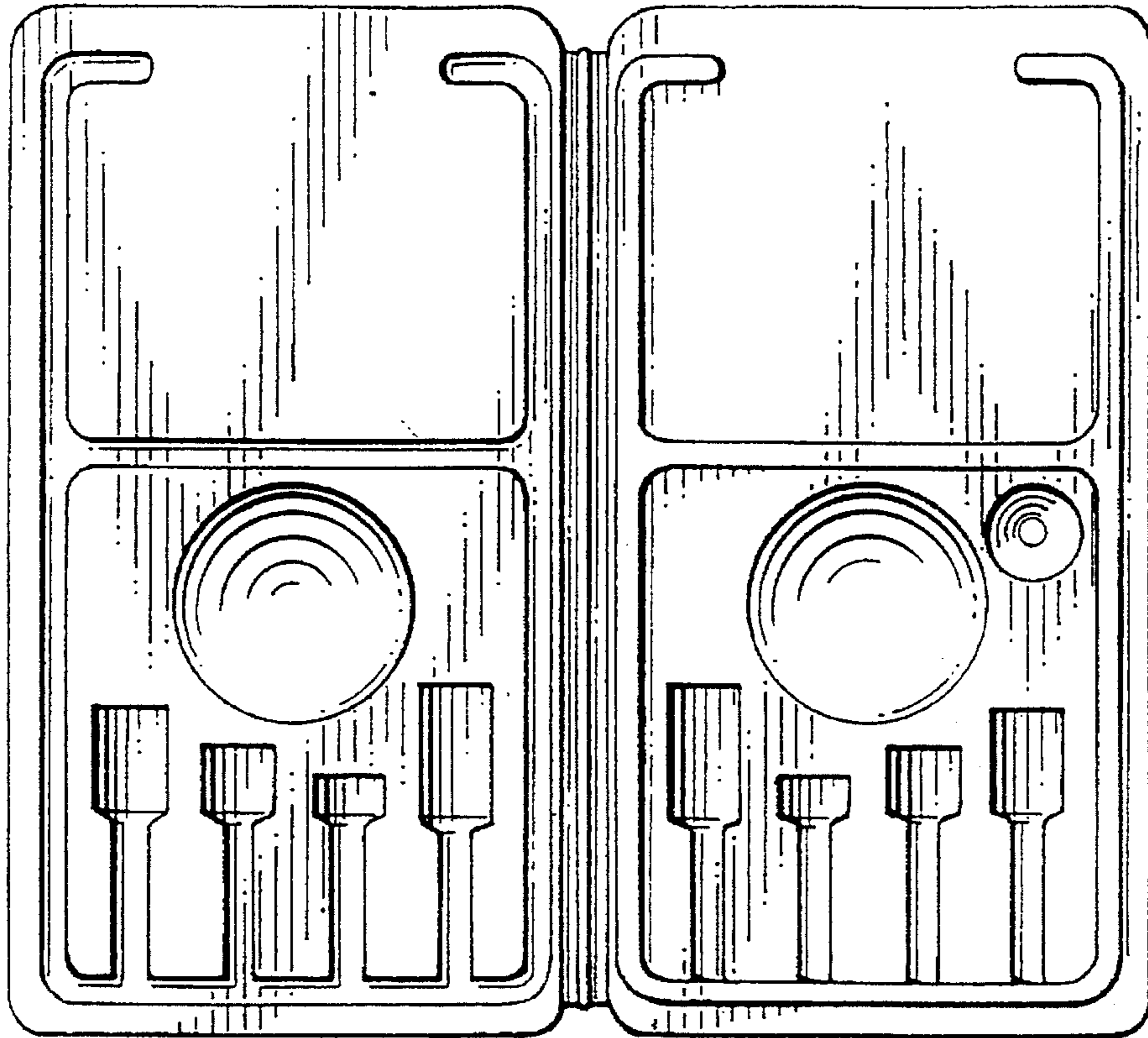

FIG. 6

FIG. 7

