



US00D365730S

United States Patent [19]

[11] Patent Number: **Des. 365,730**

Brightbill et al.

[45] Date of Patent: ****Jan. 2, 1996**

[54] **UTENSIL TRAY**

[75] Inventors: **Keith E. Brightbill**, Wooster; **Charles W. Craft**, Apple Creek; **John W. Koenig**, Cincinnati, all of Ohio

[73] Assignee: **Rubbermaid Incorporated**, Wooster, Ohio

[**] Term: **14 Years**

[21] Appl. No.: **32,163**

[22] Filed: **Dec. 13, 1994**

[52] U.S. Cl. **D7/641**; D3/313

[58] Field of Search D7/637-641, 550, D7/553-554; D3/304, 313, 314; 206/553, 557, 562, 564; 211/60.1, 70.1, 70.7; 220/23.83

[56] **References Cited**

U.S. PATENT DOCUMENTS

- D. 332,553 1/1993 *Giugiaro* D7/637
- D. 352,868 11/1994 *Breen* D7/637
- D. 353,078 12/1994 *Davis et al.* D7/637

OTHER PUBLICATIONS

Sell sheet, Cutlery tray; Ingrid, 1419 Lake Cook Road, Suite 200, Deerfield, Ill. 60015. Publication date Aug. 12, 1990. Catalog page 3, Cutlery tray; Tucker Housewares, 25 Tucker Drive, Leominster, Mass. 01469. Publication date 1994.

Catalog page, Cutlery trays; Sterilite Corporation, P.O. Box 524, Townsend, Mass. 01469-0524. Publication date 1993. P. 7, Compartmented silverware organizer; Beacon Quality Houseware Products, address unknown. Published at least as early as Oct., 1994.

Catalog page, Cutlery tray; Mepla, Inc., P.O. Box 1469, 909 West market Center Drive, High Point, N.C. 27261-1469. Published at least as early as Oct., 1994.

Sell sheet, Organizers; Vance Industries Inc., 7401 West

Wilson Avenue, Chicago, Ill. 60656. Published at least as early as Jun., 1993.

Catalog page, Cutlery tray; Tontarelli SPA, Via Camerano, 5-60022, Castelfidardo (AN). Published at least as early as Jun., 1993.

Catalog page, Trays; Dupol-Rubbermaid GmbH, An der Trift 63, D-6072 Dreieich, Germany. Publication date 1971. Catalog page, Cutlery trays; Dupol-Rubbermaid GmbH, An der Trift 63, D-6072 Dreieich, Germany, Publication date 1988.

P. 7, Cutlery trays; Rubbermaid Incorporated, 1147 Akron Road, Wooster, Ohio 44691. Publication date 1964.

P. 13, Cutlery trays; Rubbermaid Party Plan, Chillicothe, Ohio. Publication date May, 1979.

Catalog page, Cutlery trays; Rubbermaid Incorporated, 1147 Akron Road, Wooster, Ohio 44691. Publication date 1983.

Sell sheet, Cutlery trays; Rubbermaid Incorporated, 1147 Akron Road, Wooster, Ohio 44691. Publication date 1989.

P. 5, Cutlery trays; Rubbermaid Incorporated, 1147 Akron Road, Wooster, Ohio 44691. Publication date 1990.

Primary Examiner—Terry A. Wallace

Attorney, Agent, or Firm—Richard B. O'Planick; Lisa B. Riedesel

[57] **CLAIM**

The ornamental design for an utensil tray, as shown and described.

DESCRIPTION

FIG. 1 is a top right front perspective view of an utensil tray showing our new design;

FIG. 2 is a top plan view thereof;

FIG. 3 is a front elevational view thereof;

FIG. 4 is a rear elevational view thereof;

FIG. 5 is a right side elevational thereof; the left side elevational view being a mirror image; and,

FIG. 6 is a bottom plan view thereof;

1 Claim, 3 Drawing Sheets

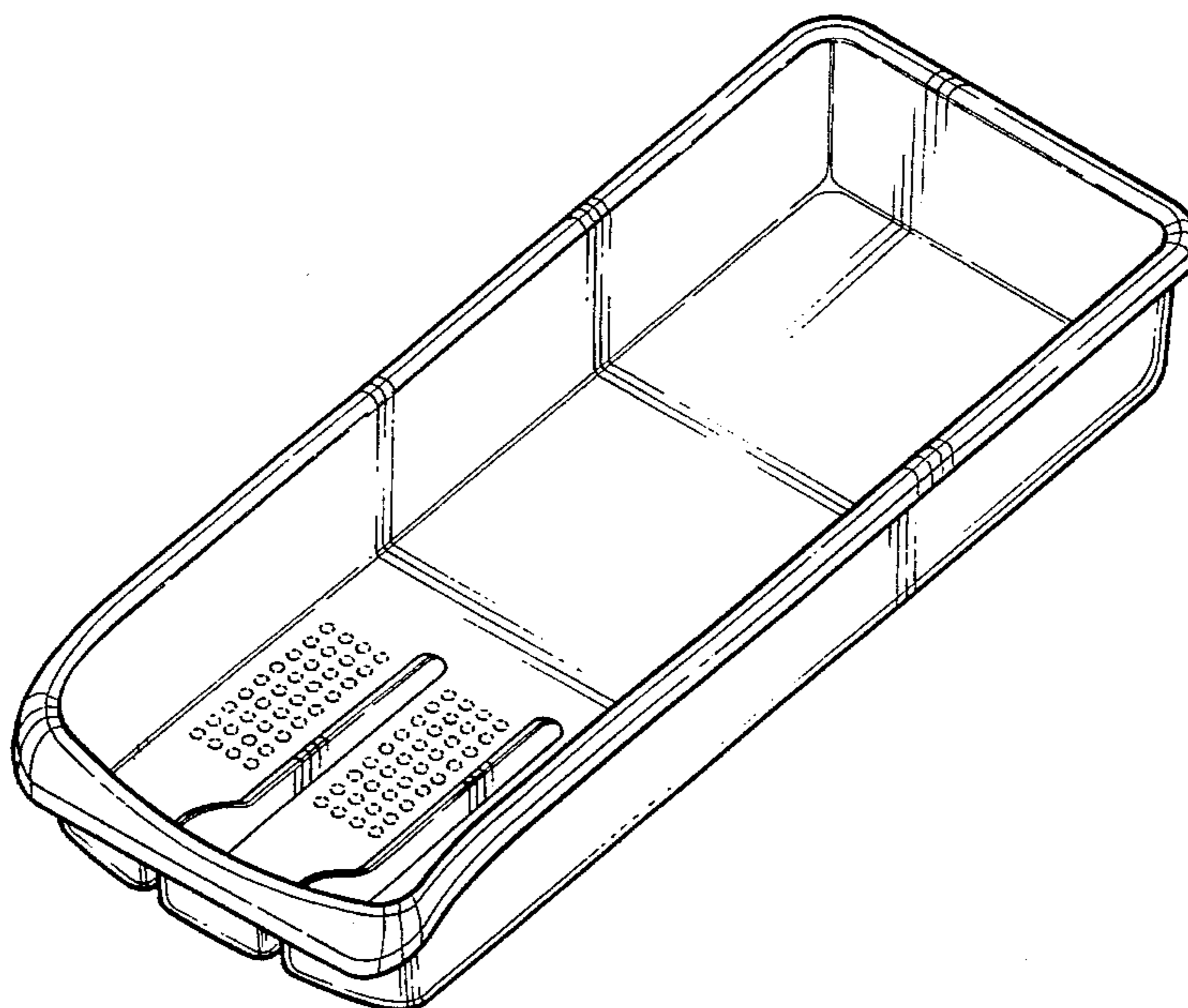

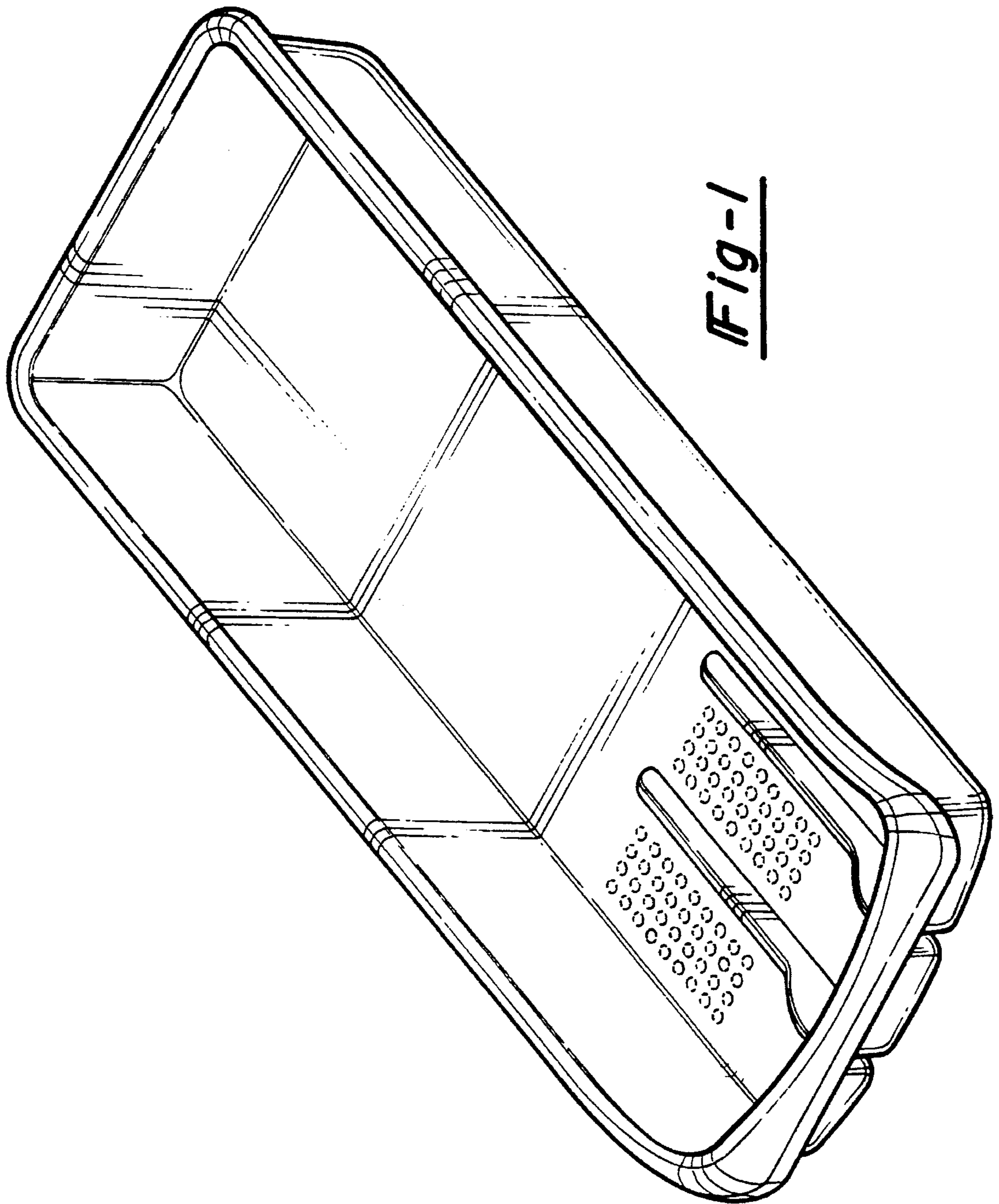

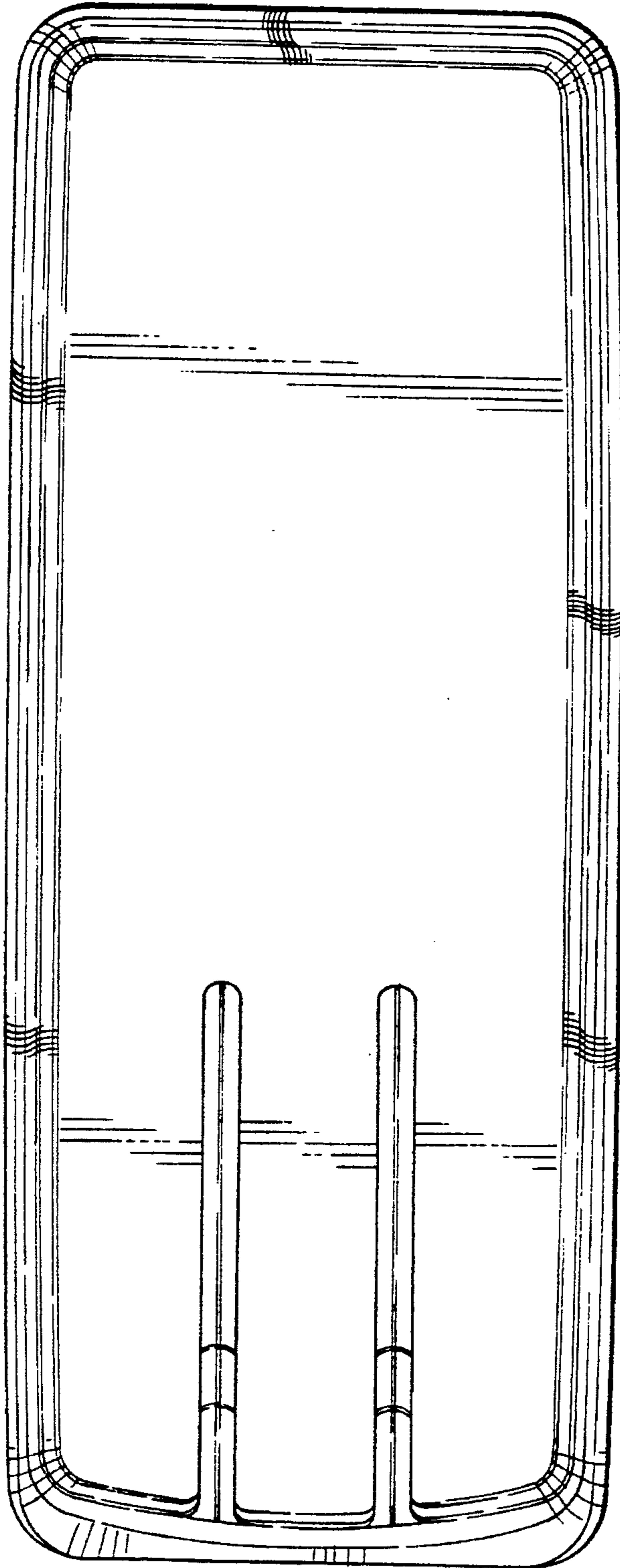

Fig-2

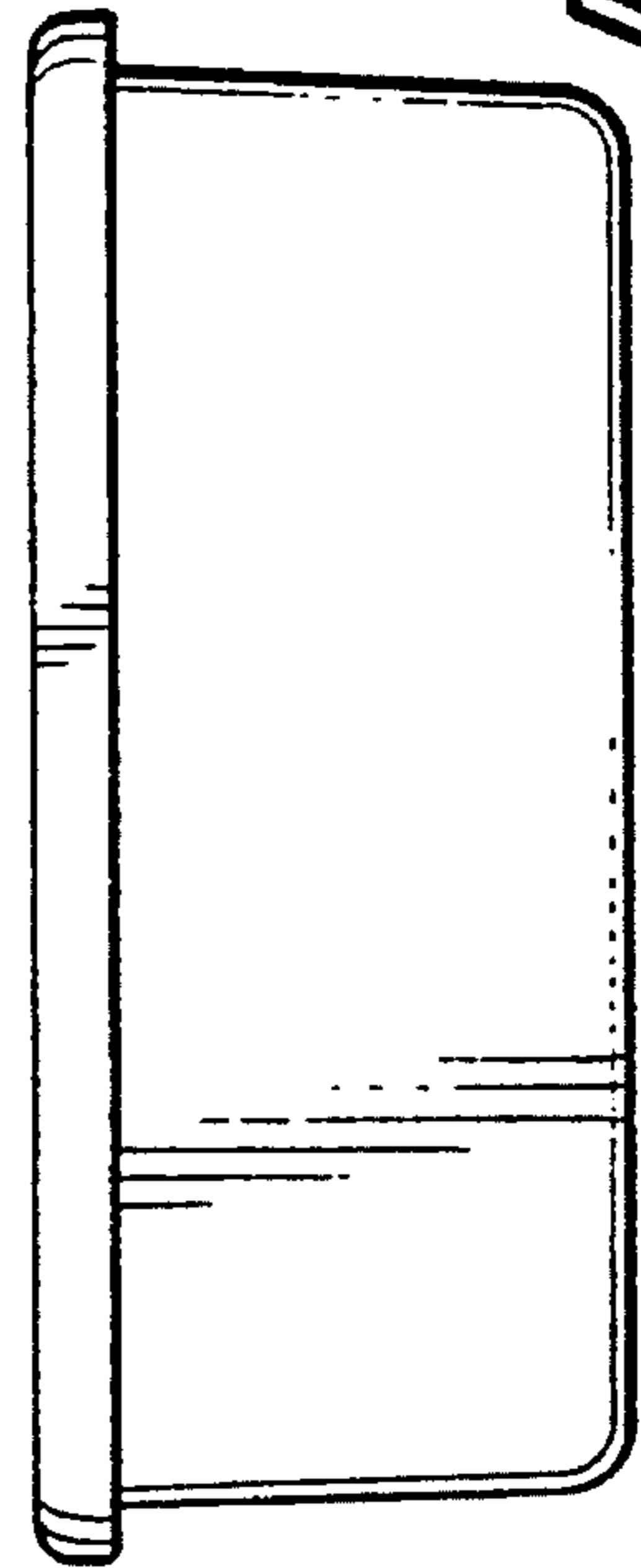

Fig-4

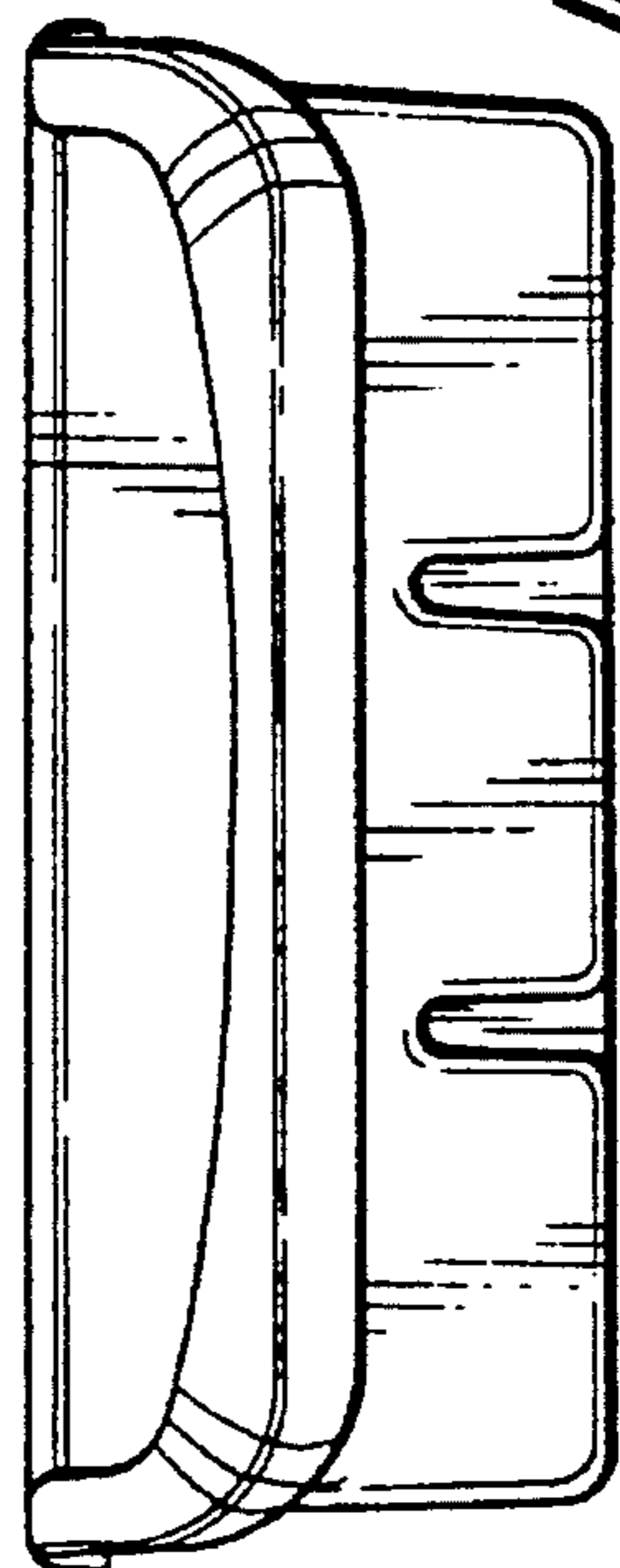

Fig-3

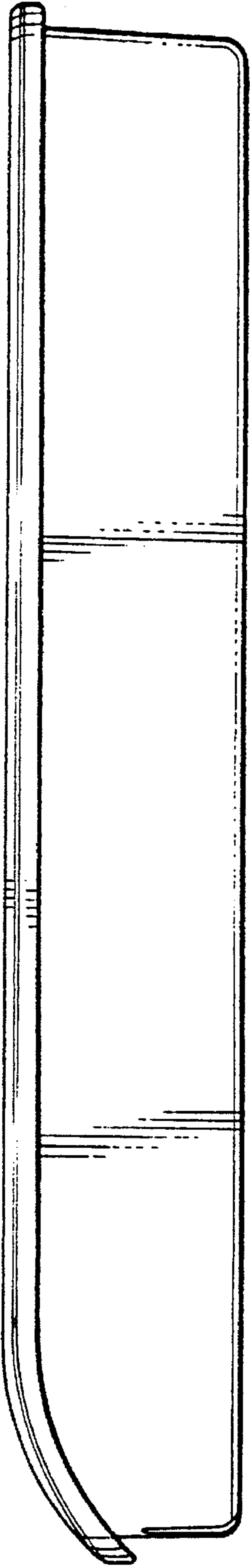

Fig-5

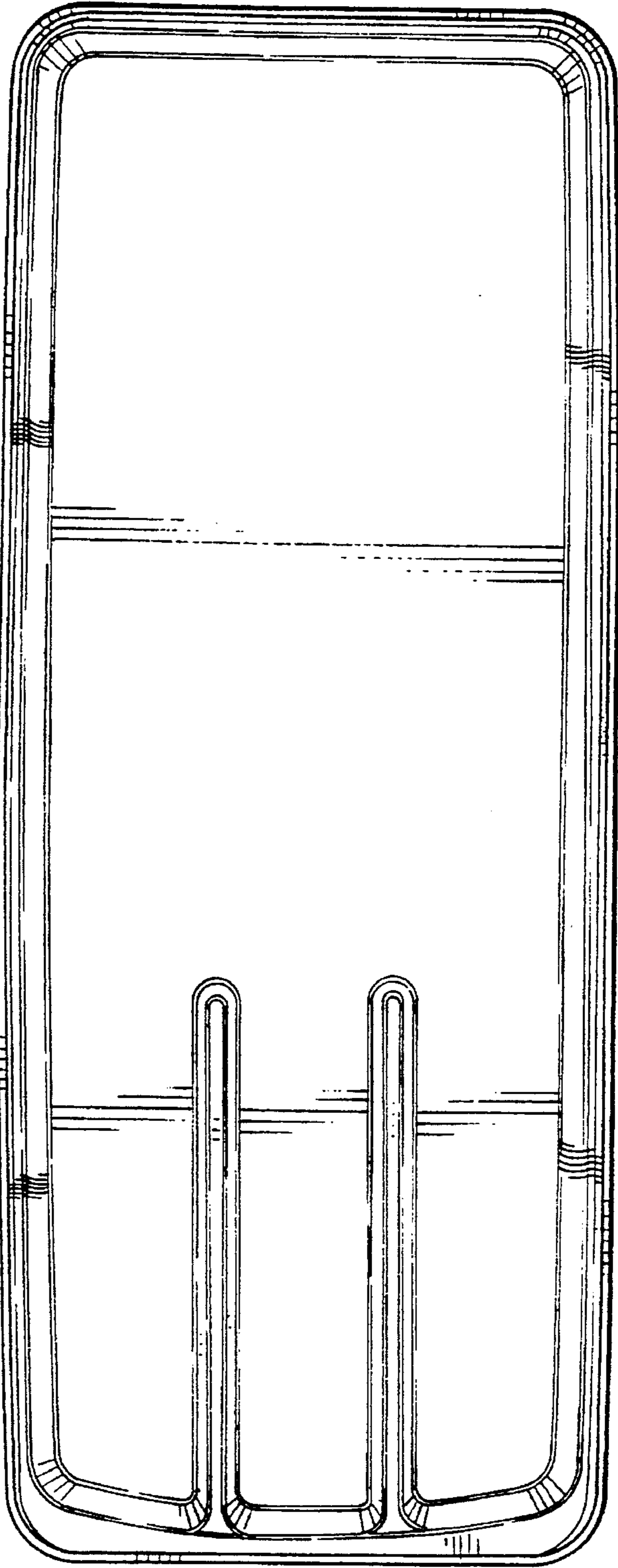

Fig-6