



US00D365718S

United States Patent [19]

[11] Patent Number: **Des. 365,718**

Morin

[45] Date of Patent: ****Jan. 2, 1996**

[54] **MEDICINE CABINET**

[75] Inventor: **Andre Morin**, Pointe-Claire, Canada

[73] Assignee: **Maax Inc.**, Sainte-Marie, Canada

[**] Term: **14 Years**

[21] Appl. No.: **34,954**

[22] Filed: **Feb. 16, 1995**

[52] U.S. Cl. **D6/561**

[58] Field of Search D6/559-561; 312/209, 312/224, 227, 242, 245, 294-295

[56] **References Cited**

U.S. PATENT DOCUMENTS

D. 303,896	10/1989	Baus	D6/559 X
D. 313,719	1/1991	Bressler et al.	D6/559 X
4,695,929	9/1987	Smith	312/227

OTHER PUBLICATIONS

Marienbad brochure (1983) mirror assembly 02111-82.

Primary Examiner—Brian N. Vinson

Attorney, Agent, or Firm—Ronald S. Kosie; Robert Brouillette

[57] **CLAIM**

The ornamental design for a medicine cabinet, as shown.

DESCRIPTION

FIG. 1 is a perspective view of the medicine cabinet;

FIG. 2 is a left elevation view of the medicine cabinet of FIG. 1;

FIG. 3 is a right elevation view of the medicine cabinet of FIG. 1;

FIG. 4 is a front view of the medicine cabinet of FIG. 1;

FIG. 5 is a top view of the medicine cabinet of FIG. 1;

FIG. 6 is a bottom view of the medicine cabinet of FIG. 1;

FIG. 7 is a perspective view of another particular embodiment of the medicine cabinet of FIG. 1;

FIG. 8 is a left elevation view of the medicine cabinet of FIG. 7;

FIG. 9 is a right elevation view of the medicine cabinet of FIG. 7;

FIG. 10 is a front view of the medicine cabinet of FIG. 7;

FIG. 11 is a top view of the medicine cabinet of FIG. 7;

FIG. 12 is a bottom view of the medicine cabinet of FIG. 7;

FIG. 13 is a perspective view of further particular embodiment of the medicine cabinet of FIG. 1;

FIG. 14 is a left elevation view of the medicine cabinet of FIG. 13;

FIG. 15 is a right elevation view of the medicine cabinet of FIG. 13;

FIG. 16 is a front view of the medicine cabinet of FIG. 13;

FIG. 17 is a top view of the medicine cabinet of FIG. 13;

FIG. 18 is a bottom view of the medicine cabinet of FIG. 13.

1 Claim, 6 Drawing Sheets

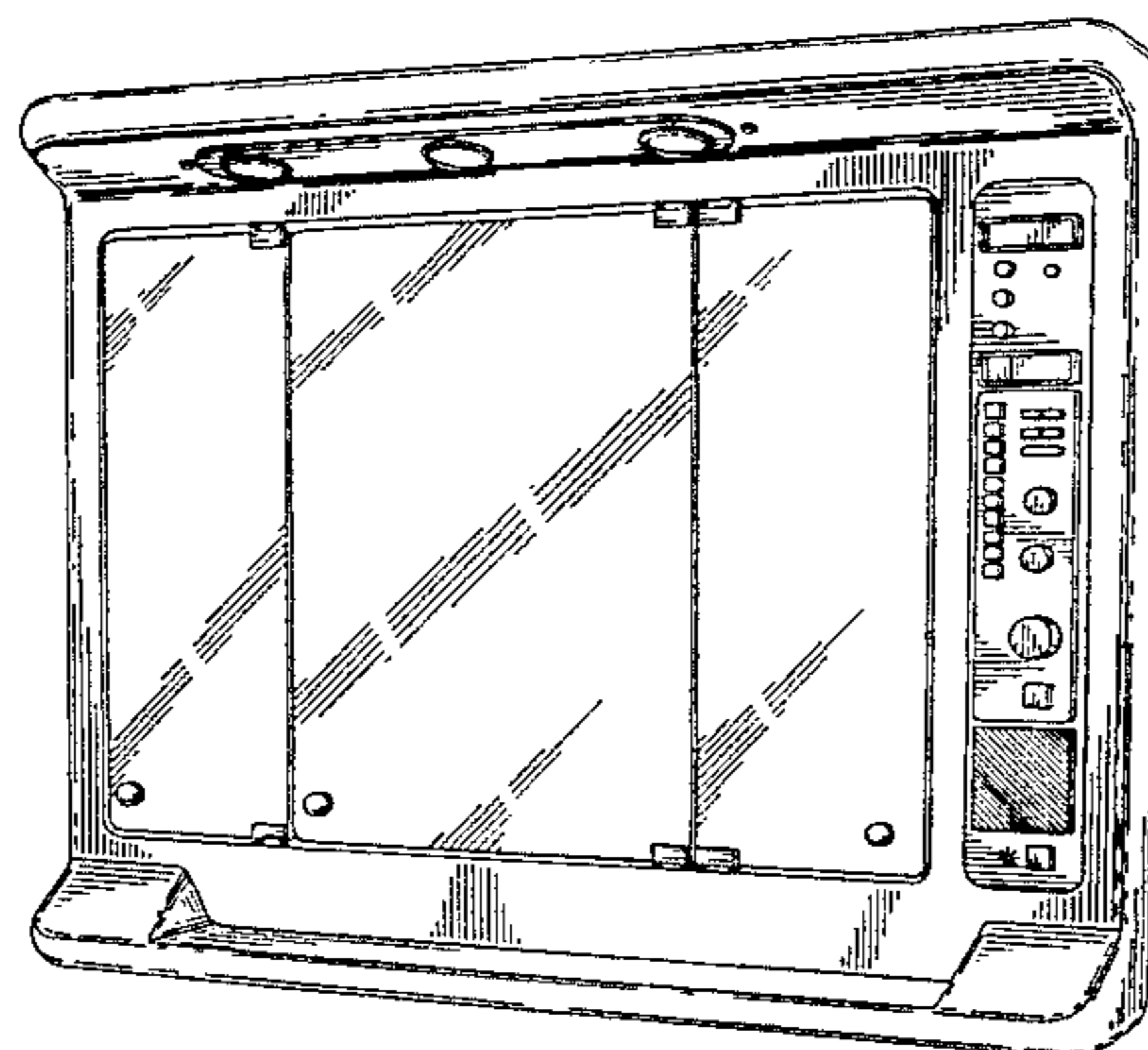
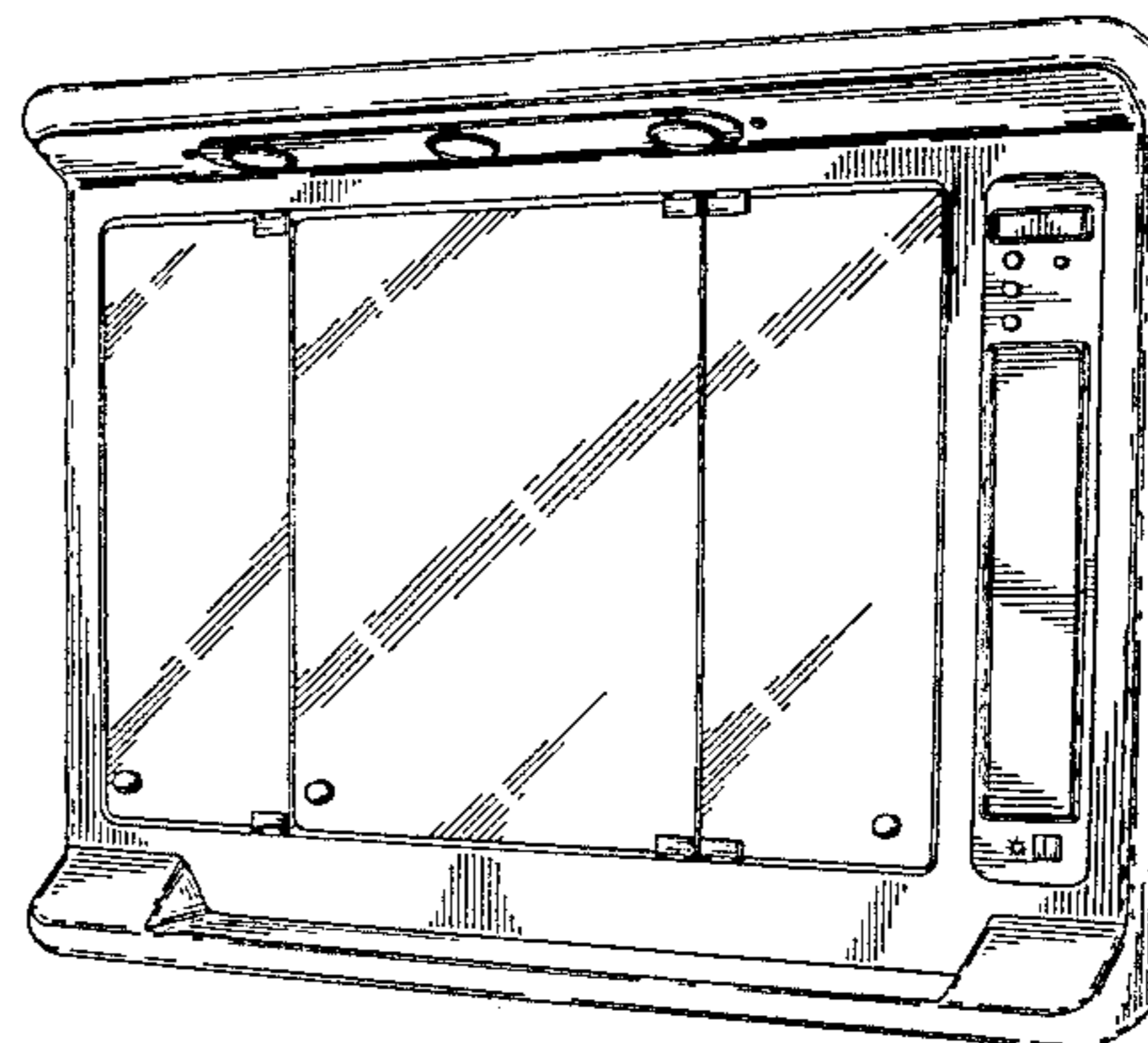
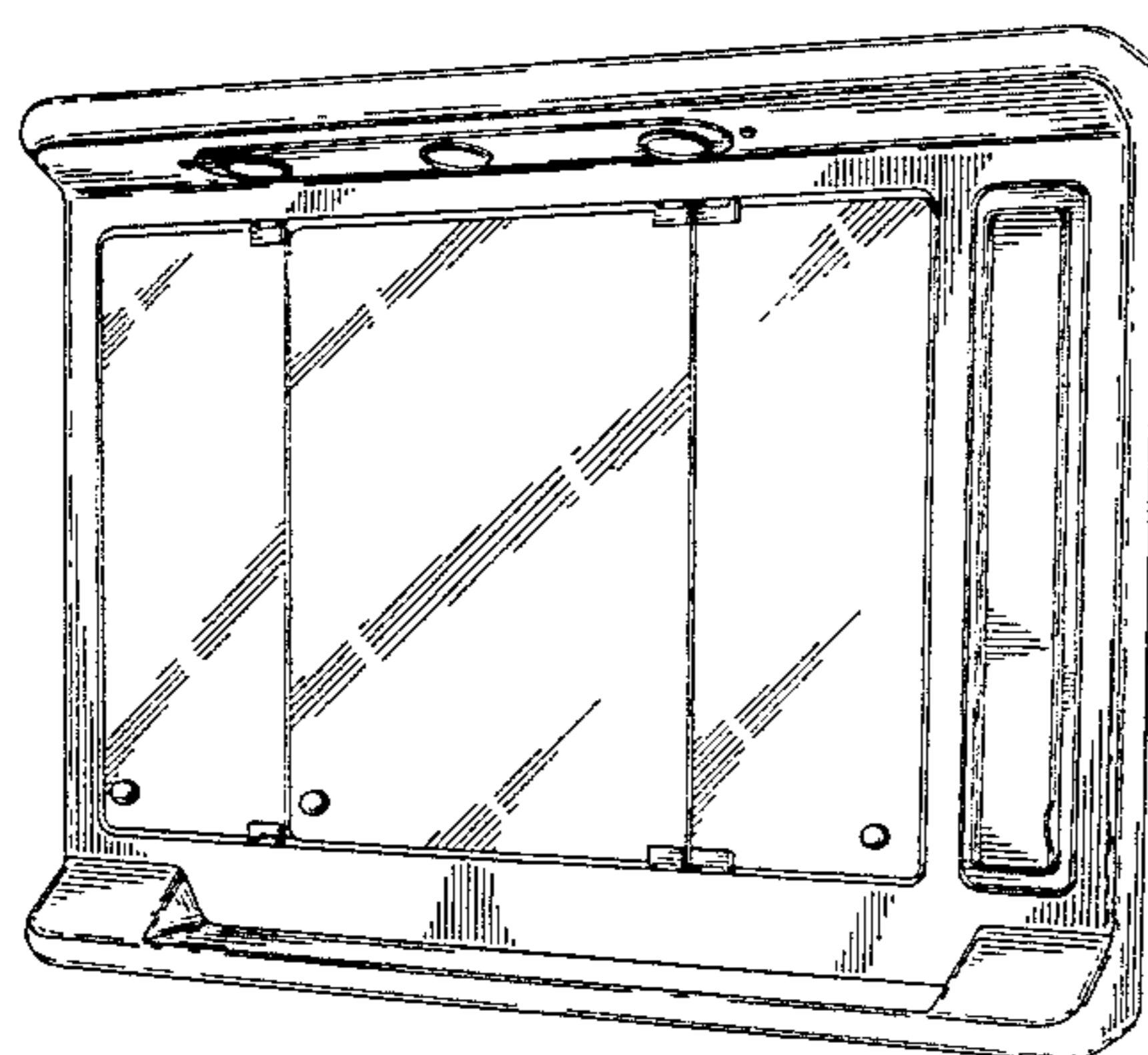

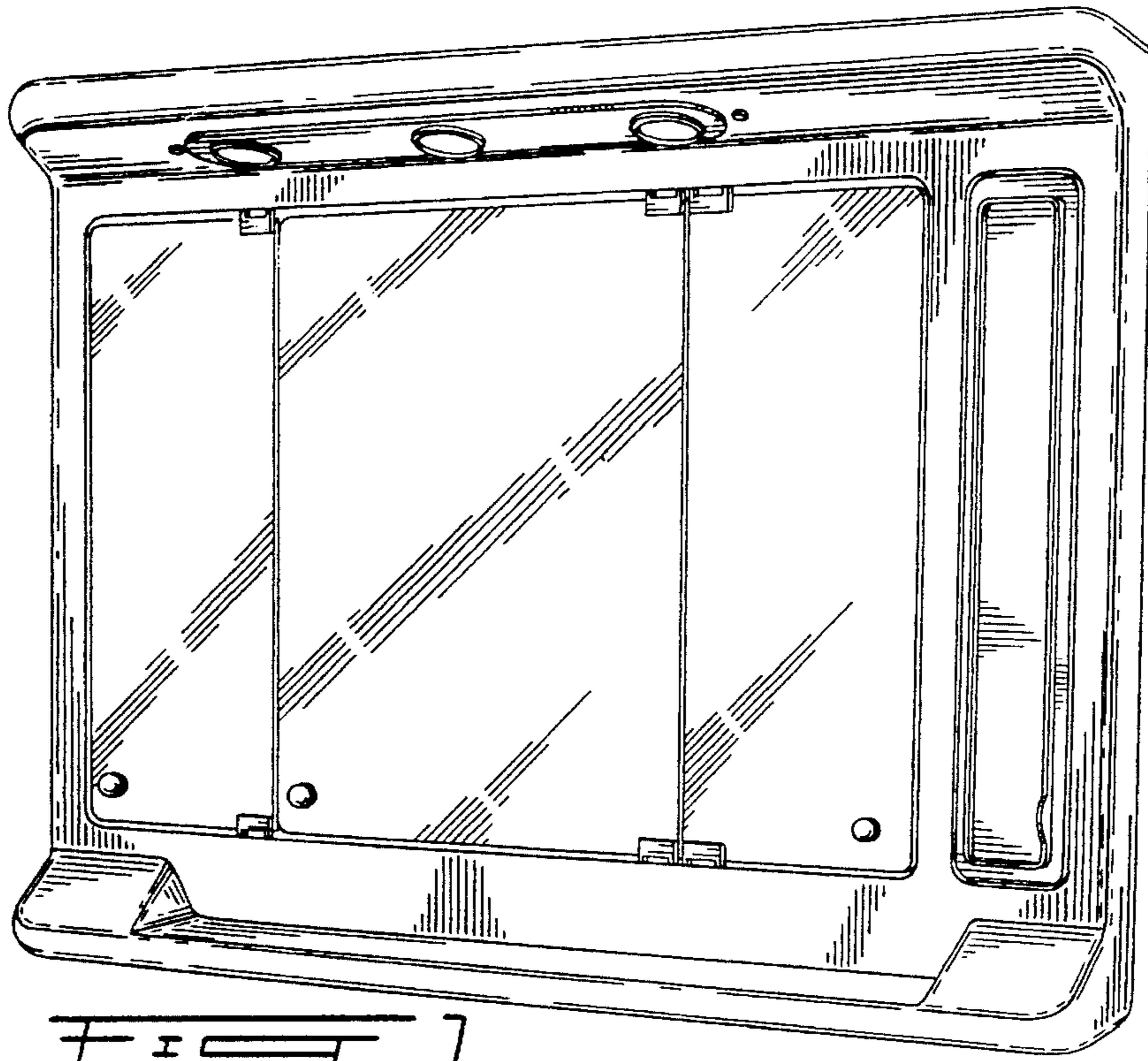

FIG. 1

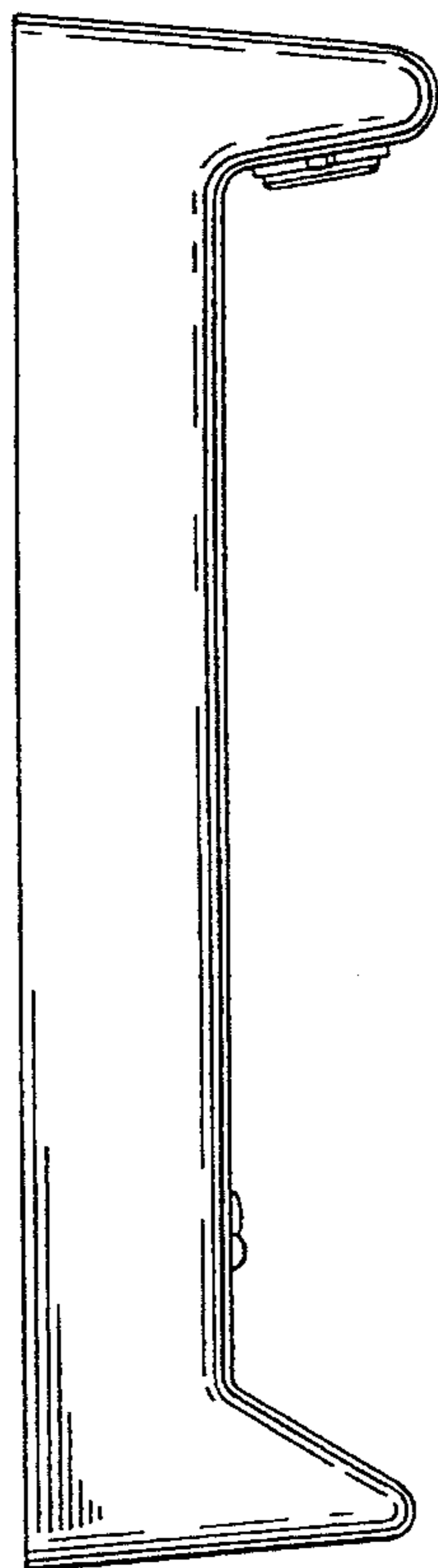

FIG. 2

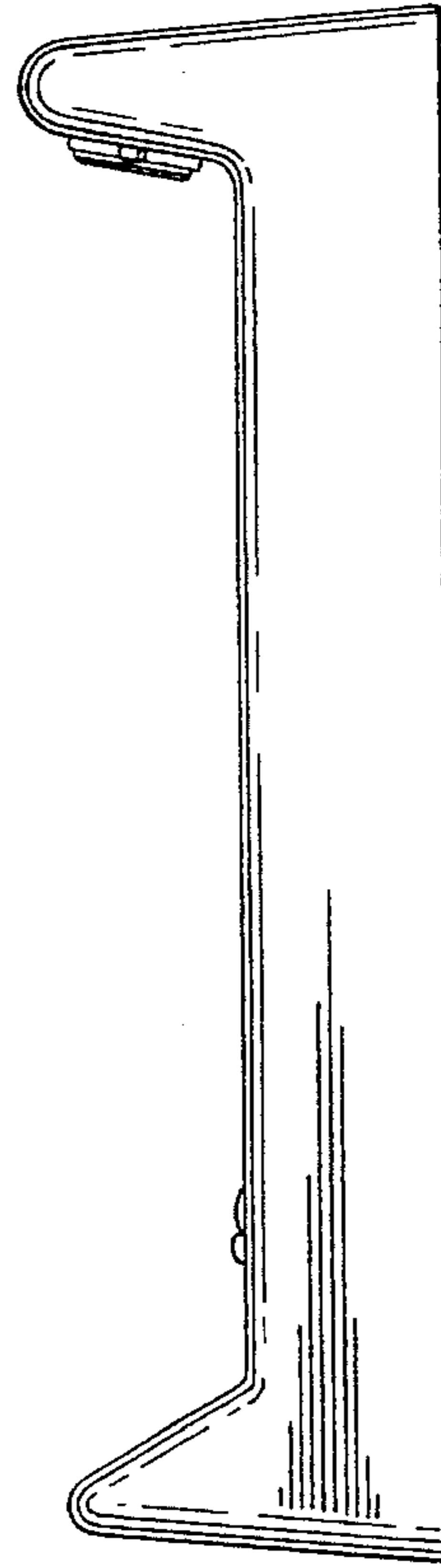

FIG. 3

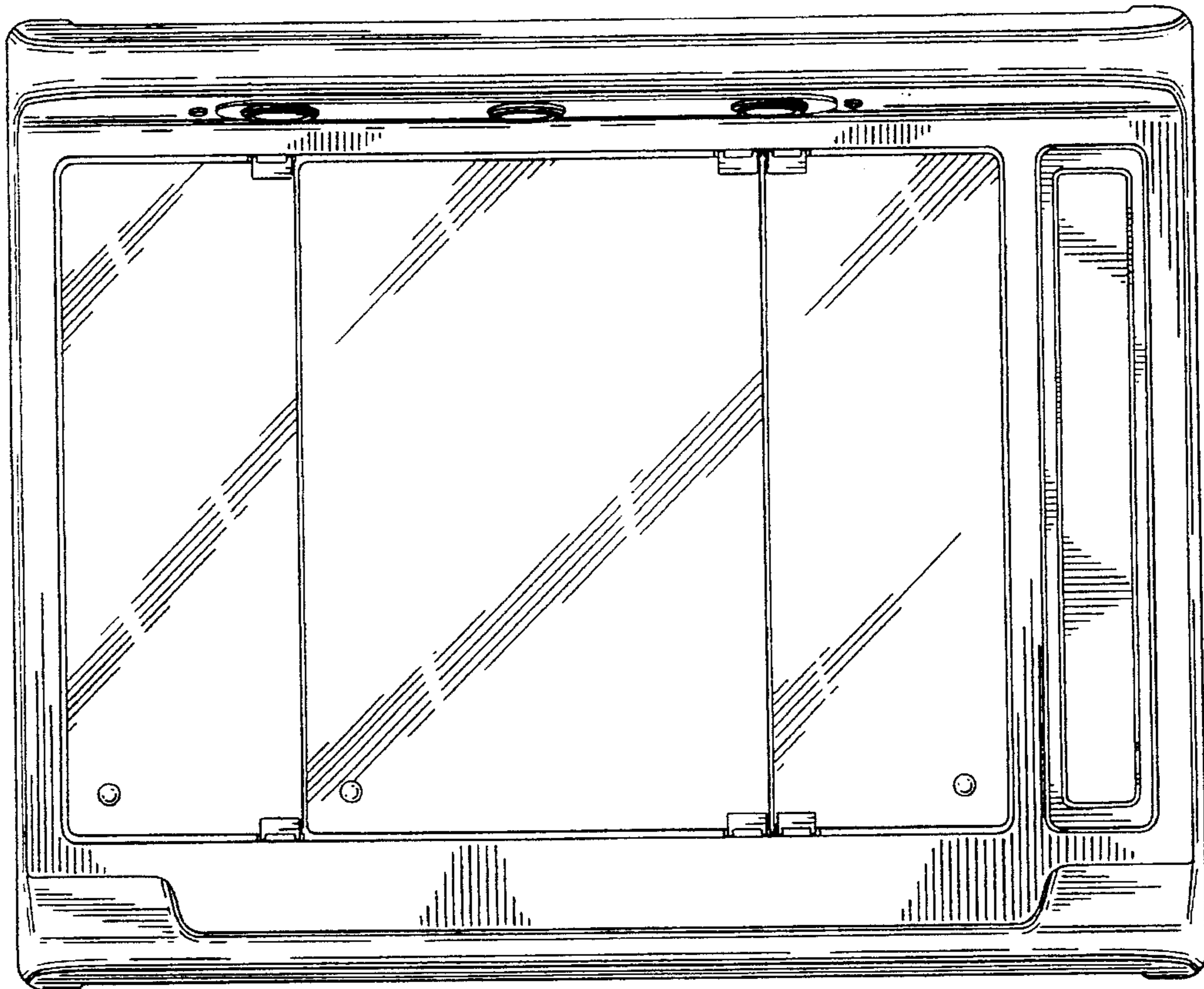

FIG. 4

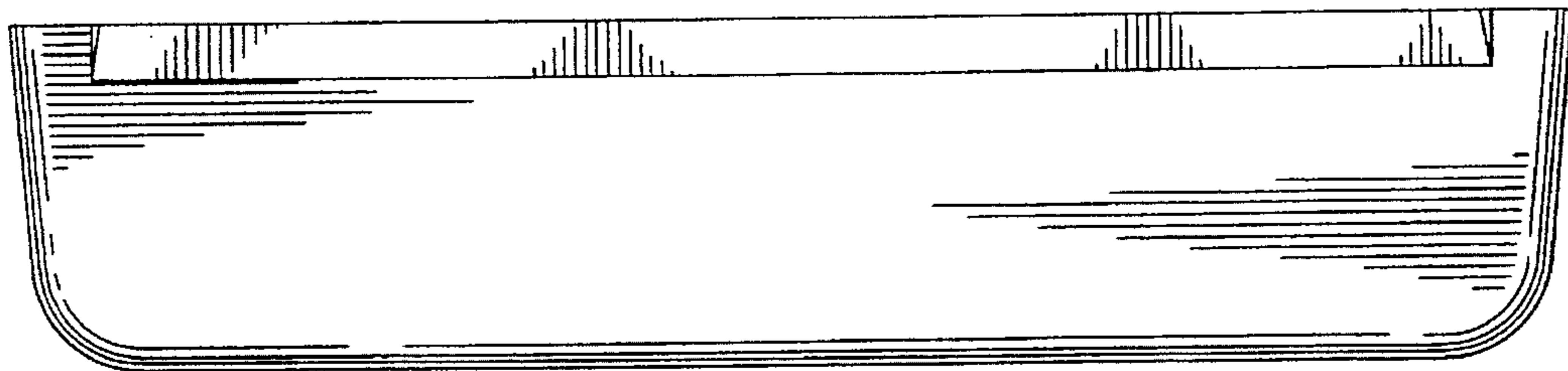

FIG. 5

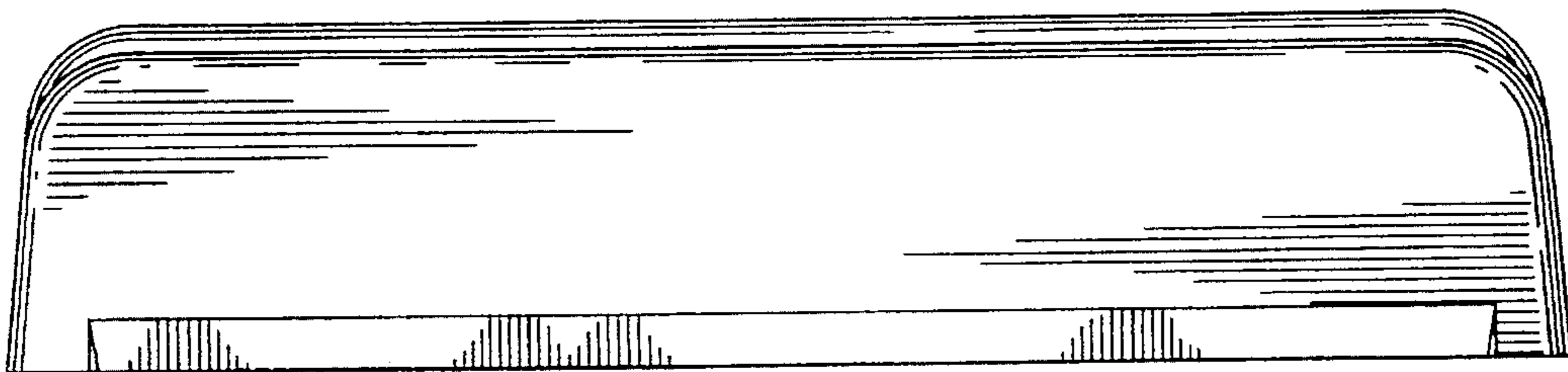
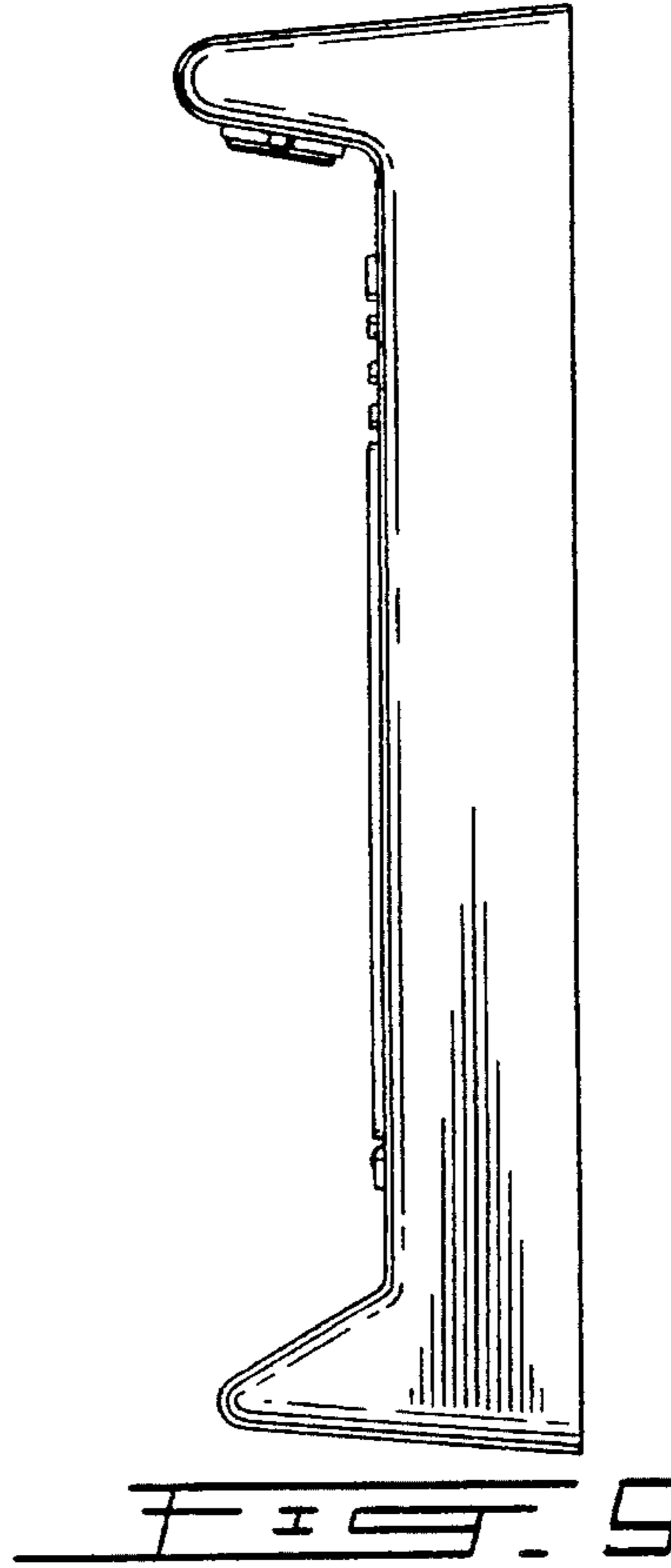
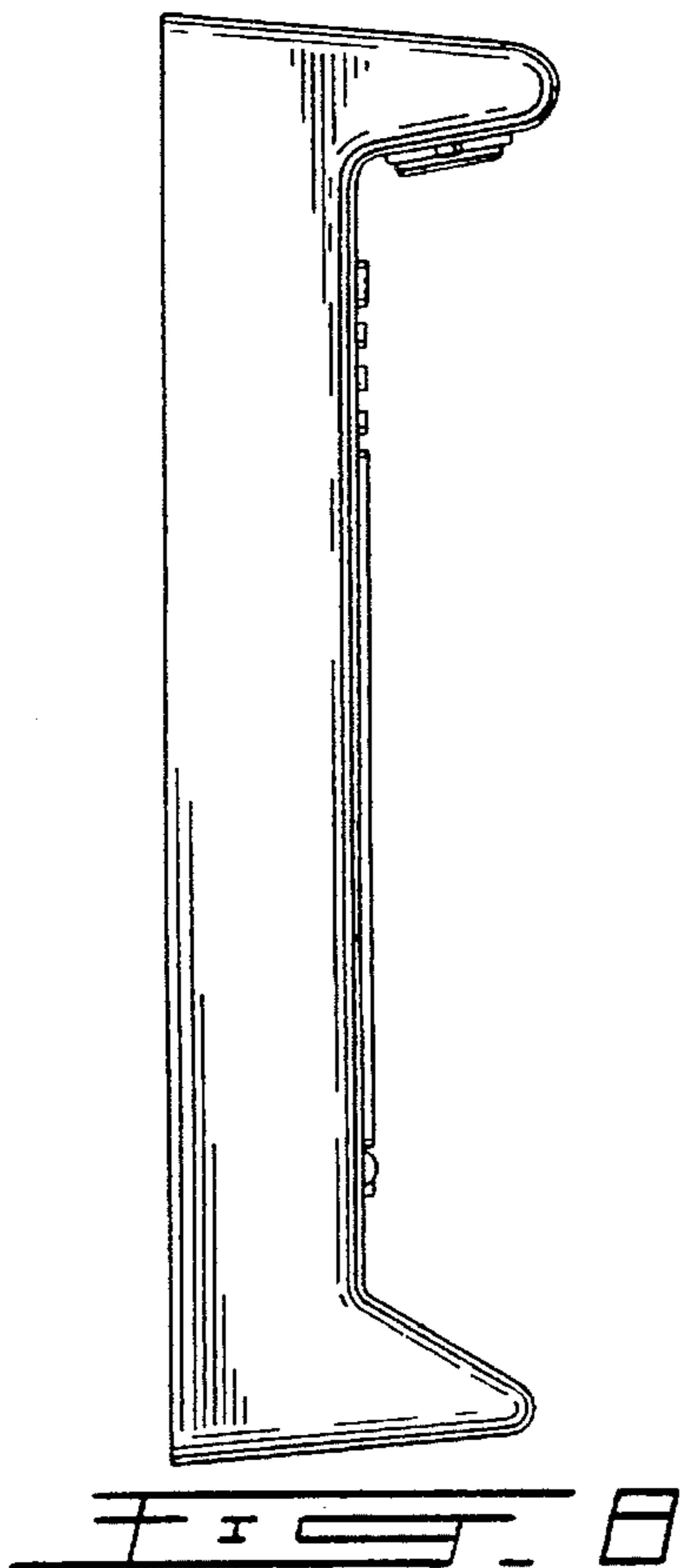
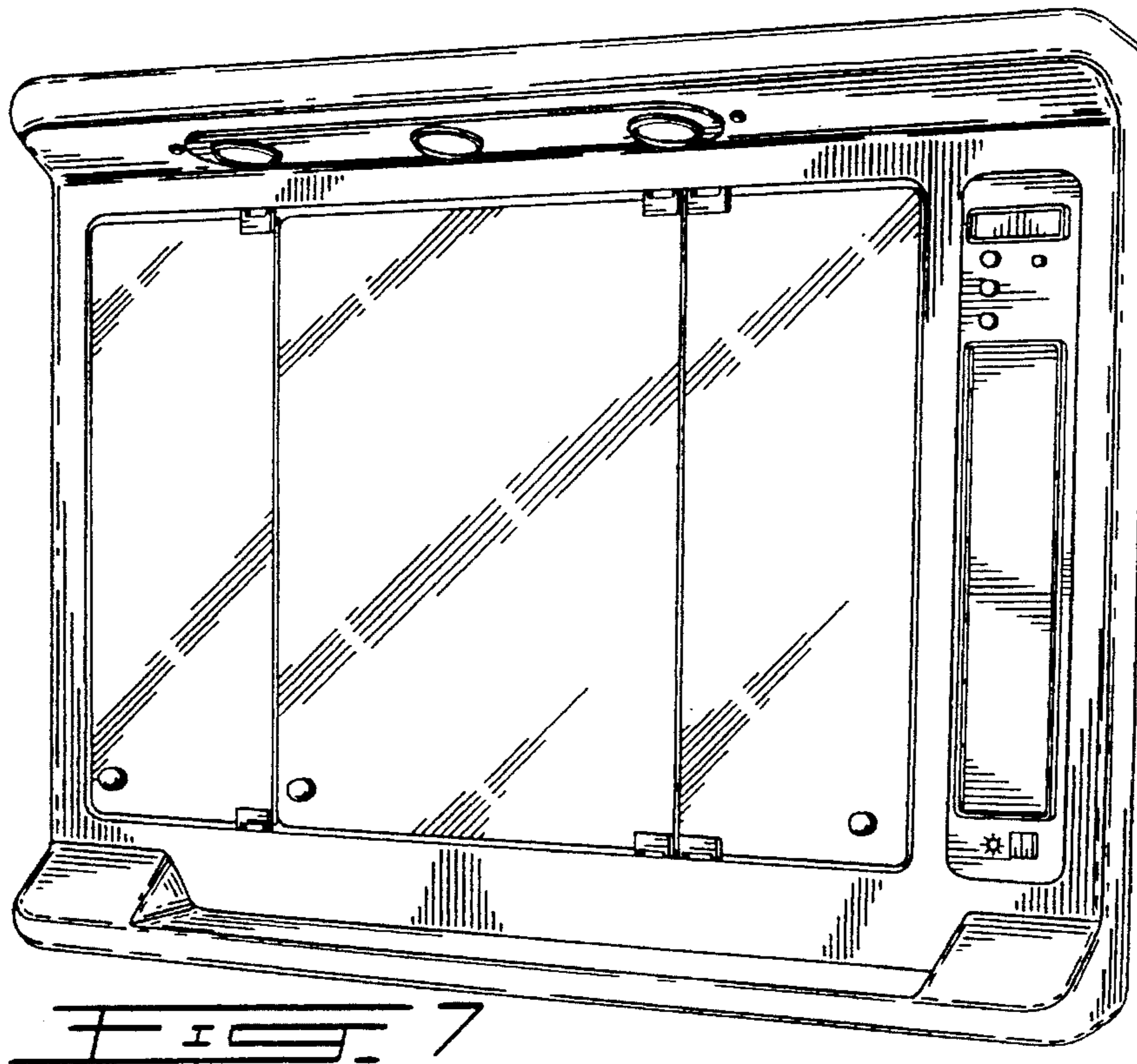

FIG. 6



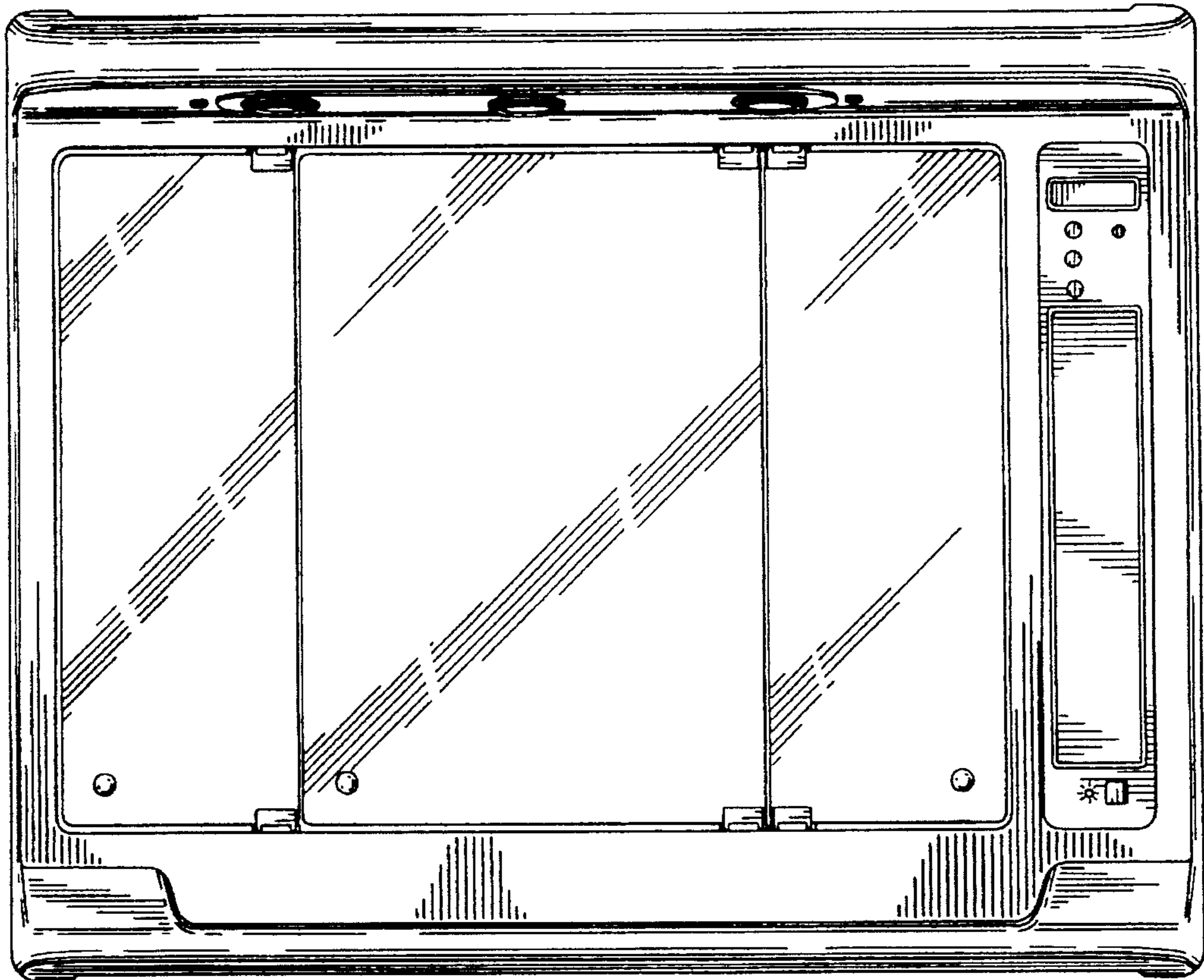

FIG. 10

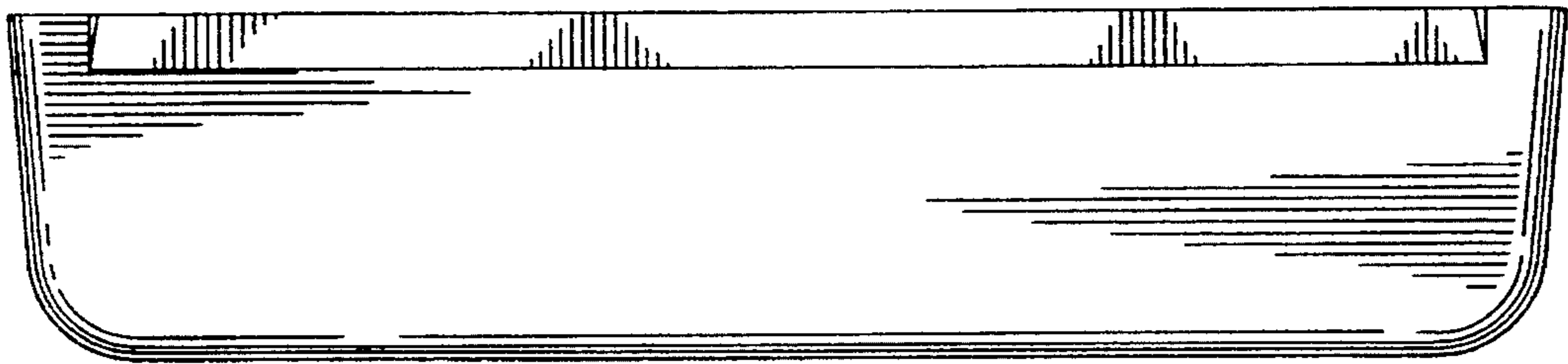

FIG. 11

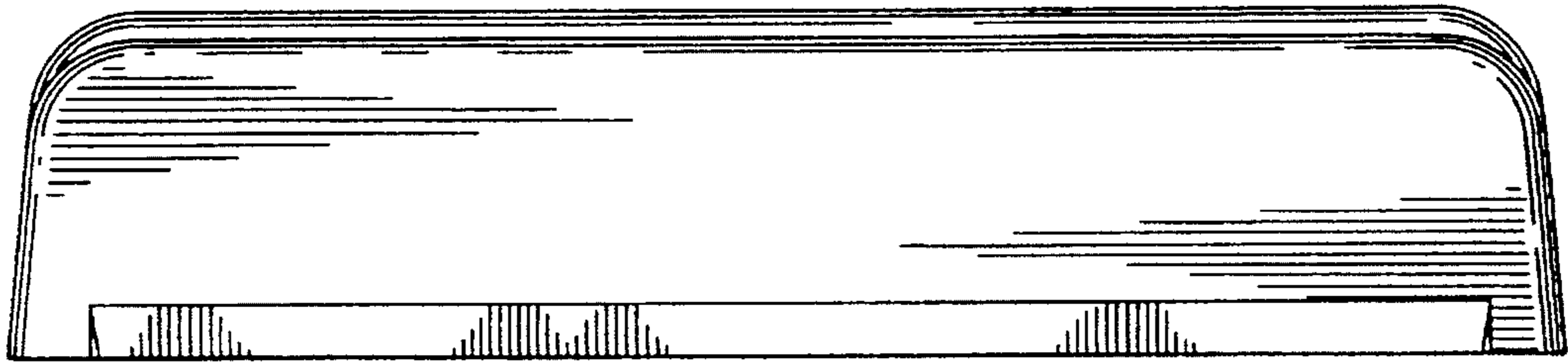

FIG. 12

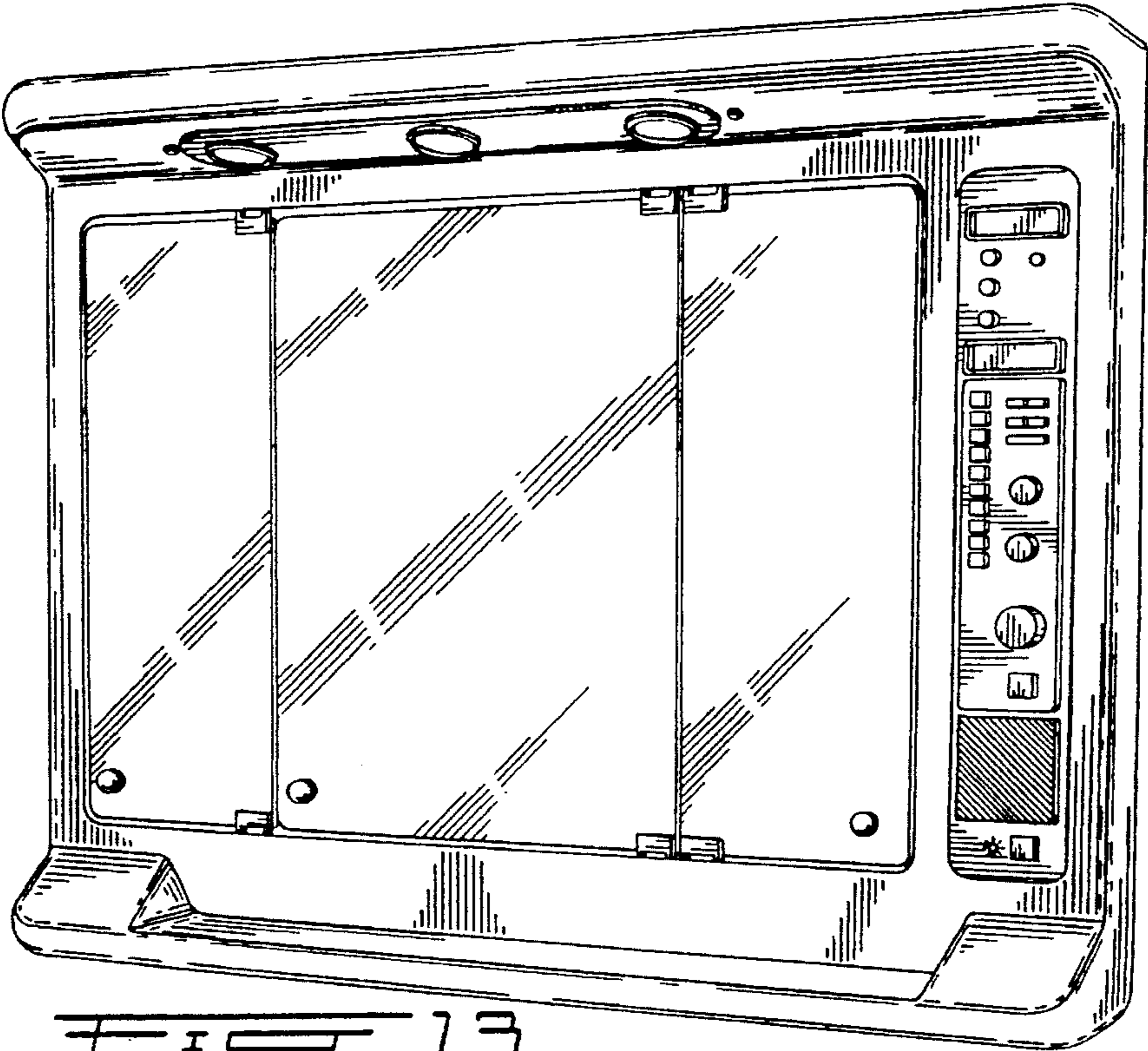

FIG. 13

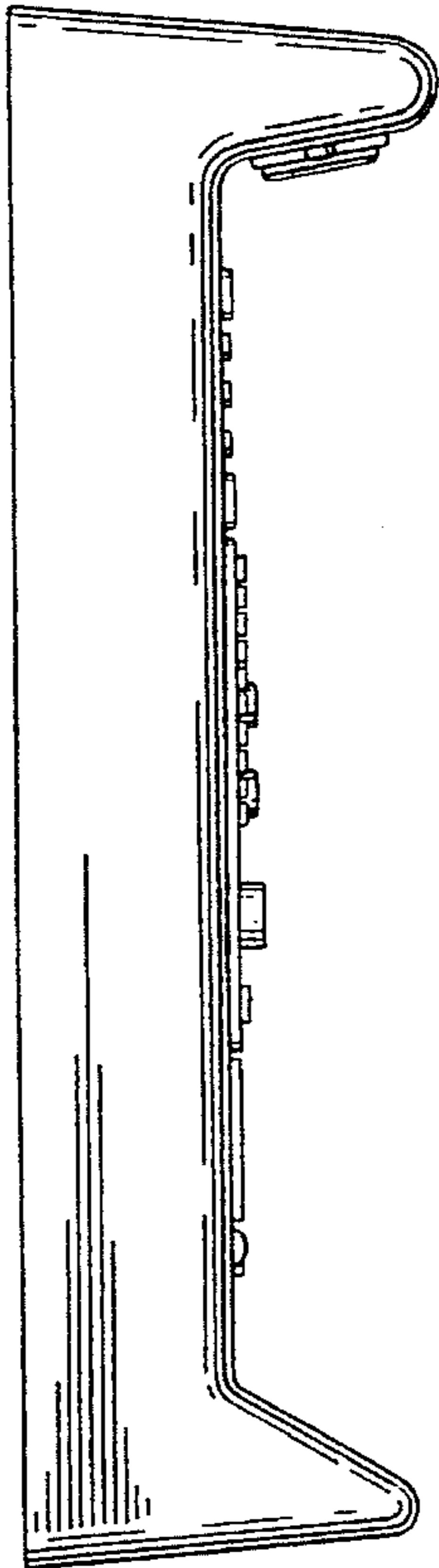

FIG. 14

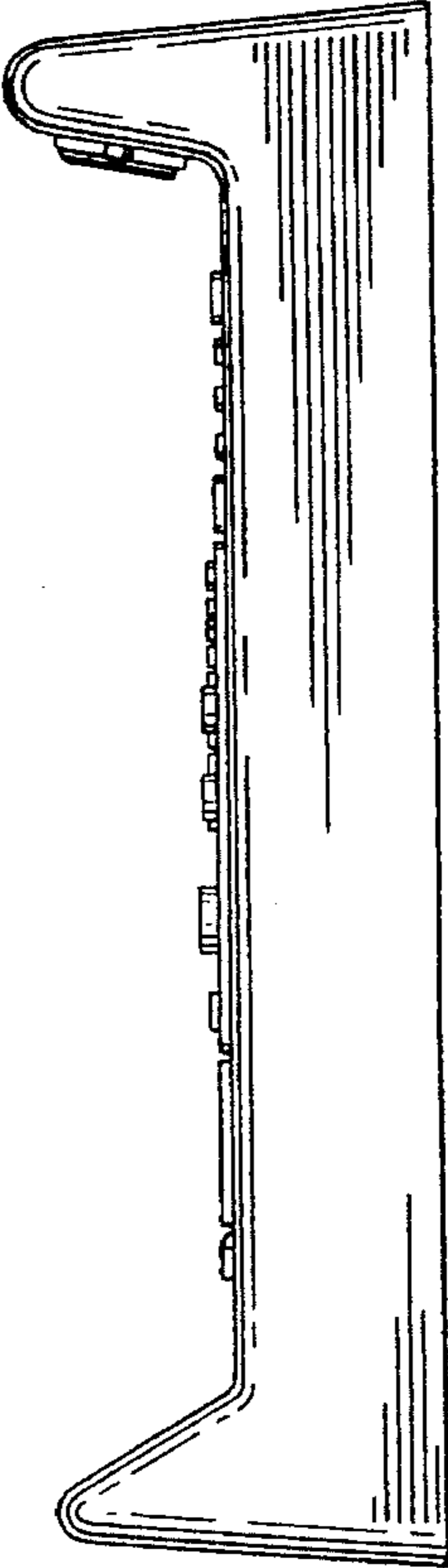

FIG. 15

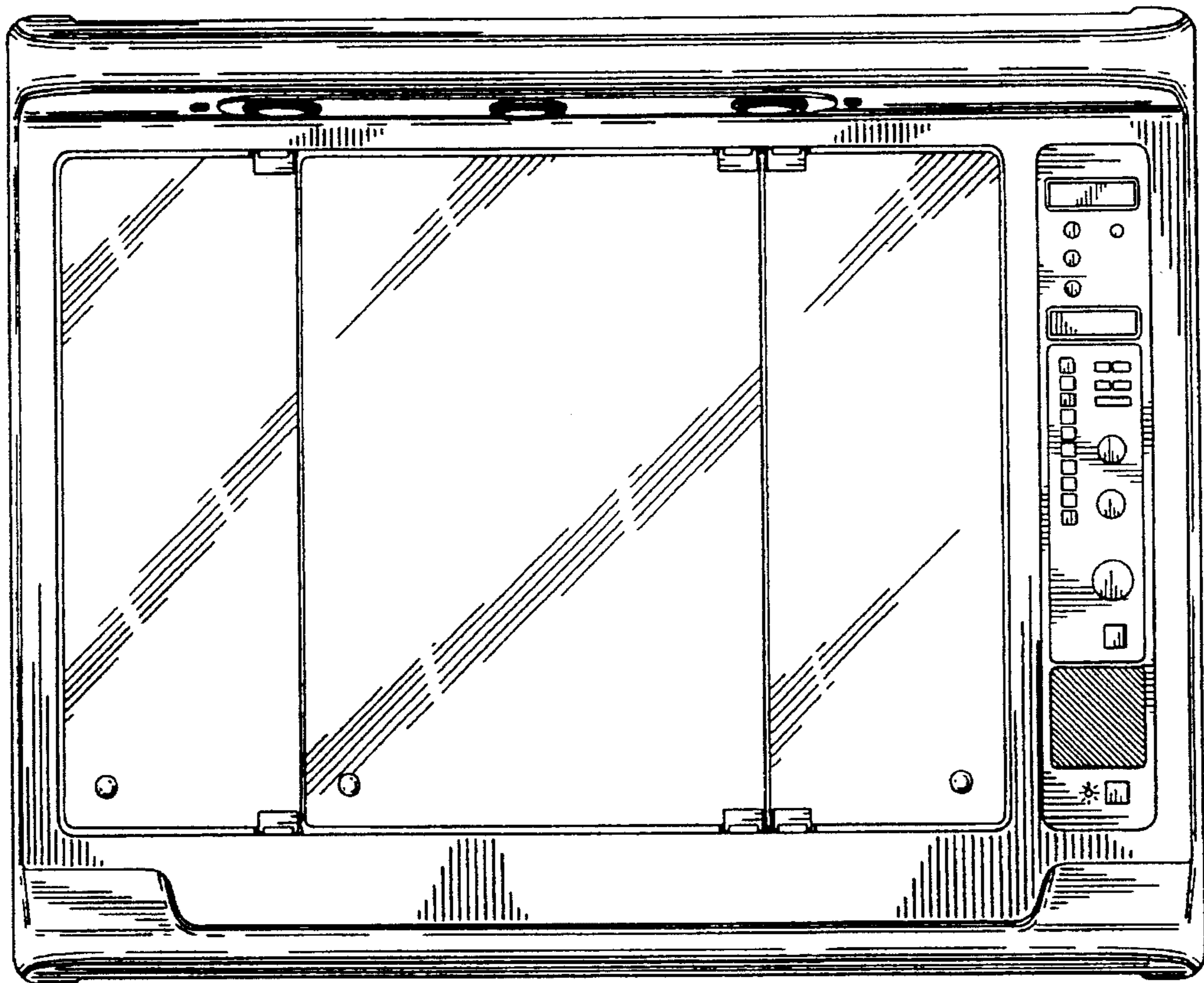

FIG. 16

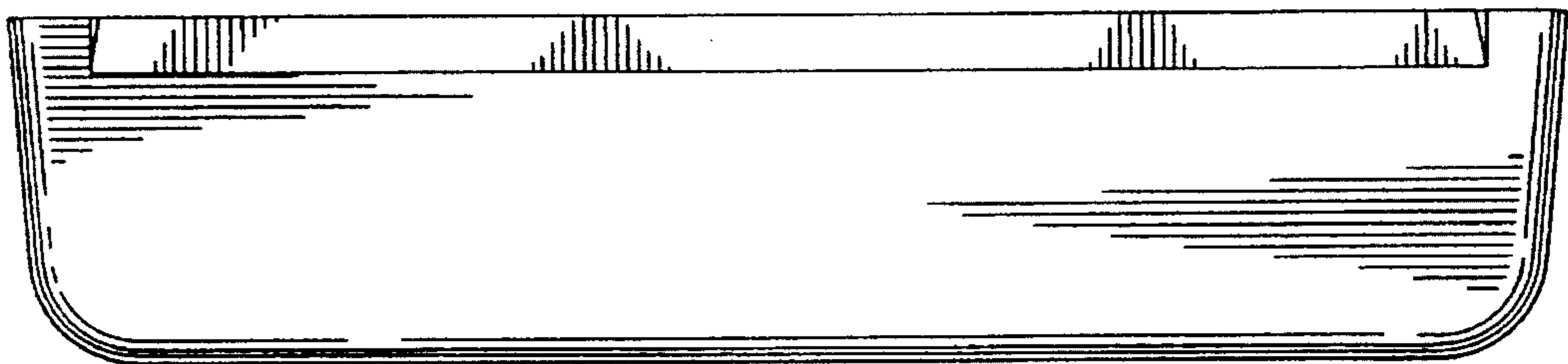

FIG. 17

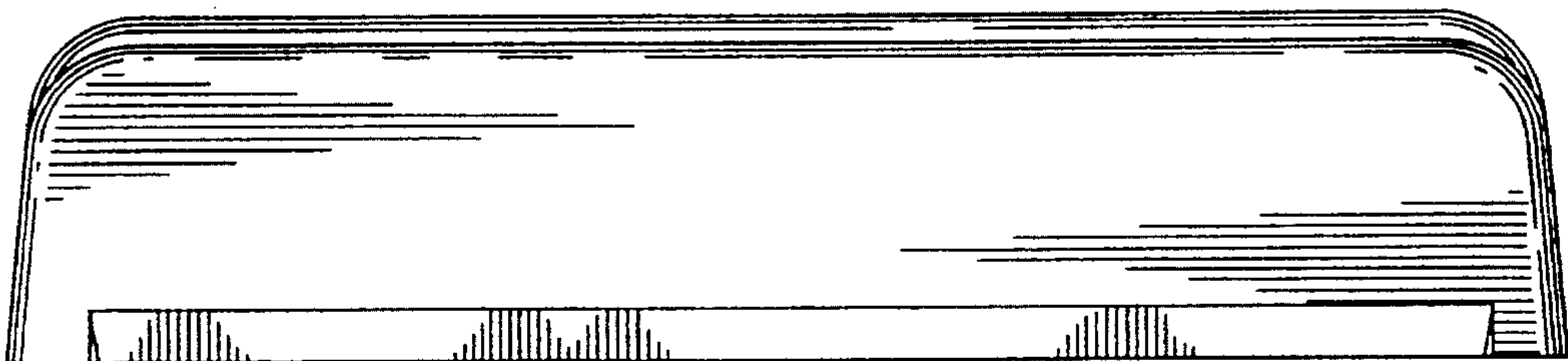

FIG. 18