



US00D365703S

United States Patent [19]

[11] Patent Number: Des. 365,703

Miller et al.

[45] Date of Patent: **Jan. 2, 1996

[54] CABINET

[75] Inventors: **D. Scott Miller**, Orlando, Fla.; **John F. Travers**, North Royalton, Ohio

[73] Assignee: **Rubbermaid Incorporated**, Wooster, Ohio

[**] Term: **14 Years**

[21] Appl. No.: **32,178**

[22] Filed: **Dec. 14, 1994**

[52] U.S. Cl. **D6/446**; D6/561

[58] Field of Search D6/432-448, 559-561, D6/509-511; 312/224, 324, 325, 198-199, 213-214, 242, 245, 283, 285

[56] References Cited

U.S. PATENT DOCUMENTS

D. 103,405	3/1937	Morgan	D6/561
D. 186,116	9/1959	Church	D6/446
D. 253,563	12/1979	Ungart	D6/561
D. 271,353	11/1983	Raz	D6/561
D. 284,050	6/1986	Brunner et al.	D6/432
D. 285,743	9/1986	Richwine	D6/561
D. 312,014	11/1990	Friedman	D6/509
D. 334,852	4/1993	Beirise	D6/436
D. 347,131	5/1994	Wolff	D6/479
1,319,603	10/1919	Monfet	D6/561 X
3,964,810	6/1976	Murphy	312/257
4,474,416	10/1984	Rogahn	312/257
4,691,644	9/1987	Frydman	108/111
5,368,380	11/1994	Mottmiller et al.	312/263

OTHER PUBLICATIONS

Pp. 9, 12, 13, 22, 25 and 26, Bath cabinets; LaMont, P.O. Box 399, Burlington, Iowa 52601. Published at least as early as May, 1993.

Catalog page, Bath cabinets; Zenith Products Corp., address unknown. Published at least as early as Sep., 1993.

Catalog page, Bath cabinets; Zenith Products Corp., address unknown. Published at least as early as Sep., 1993.

Catalog page, Bath cabinets; Zenith Products Corp. address unknown. Published at least as early as Sep., 1993.

Catalog page, Bath cabinets; Zenith Products Corp., address unknown. Published at least as early as Sep., 1993.

P. 776, Bath cabinets; Manufacturers unknown. Published at least as early as Sep., 1993.

Catalog page, Bath cabinets; Creative Bath Products, Brentwood, N.Y., 11717, Published at least as early as Sep., 1993.

Catalog page, Bath cabinets; Keter, address unknown. Published at least as early as May, 1993.

P. 9, Bath cabinets; J. C. Penney Company, Milwaukee, Wis. Published at least as early as May, 1993.

Catalog page, Bath cabinets; J. C. Penney Company, Milwaukee, Wis., Published at least as early as May, 1993.

Sell sheet, Bath cabinets; O'Sullivan, 1900 Gulf Street, Lamar, Mo. 64759. Published at least as early as May, 1993.

Catalog page, Bath cabinets; Manufacturer unknown. Published at least as early as May, 1993.

Catalog page, Bath cabinets; Manufacturer unknown. Published at least as early as May, 1993.

Catalog page, Bath cabinets; Opalo, address unknown. Published at least as early as May, 1993.

Sell sheet, Cabinets; P.I. Industries, Vista, Calif. Published at least as early as Jan., 1993.

Catalog page, Cabinet doors; Hirsh Co., address unknown. Publication date 1989.

P. 18, Changing table with drawer; The Little Tikes Company, 2180 Barlow Road, Hudson, Ohio 44236. Publication date 1986.

Primary Examiner—Carmen H. Vales-Lado

Attorney, Agent, or Firm—Richard B. O'Planick; Lisa B. Riedesel

[57] CLAIM

The ornamental design for a cabinet, as shown and described.

DESCRIPTION

FIG. 1 is a top left front perspective view of a cabinet showing our new design. The surface pattern which is fragmentally shown is understood to repeat uniformly and continuously across the entire indicated surface;

FIG. 2 is a front elevational view thereof;

FIG. 3 is a top plan view thereof;

FIG. 4 is a right side elevational view thereof; the left side elevational view being a mirror image;

FIG. 5 is a bottom plan view thereof; and,

FIG. 6 is a rear elevational view thereof.

1 Claim, 3 Drawing Sheets

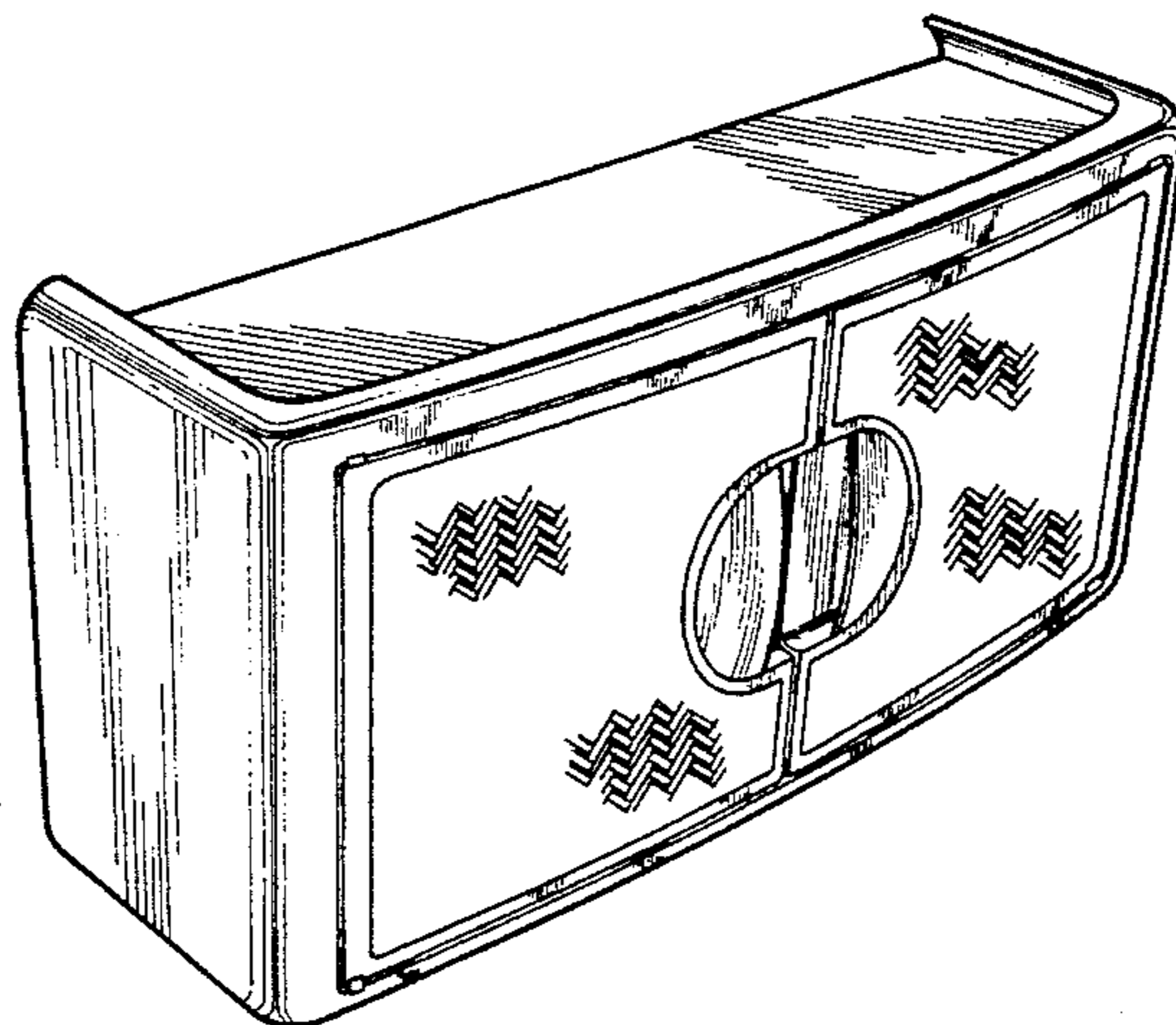

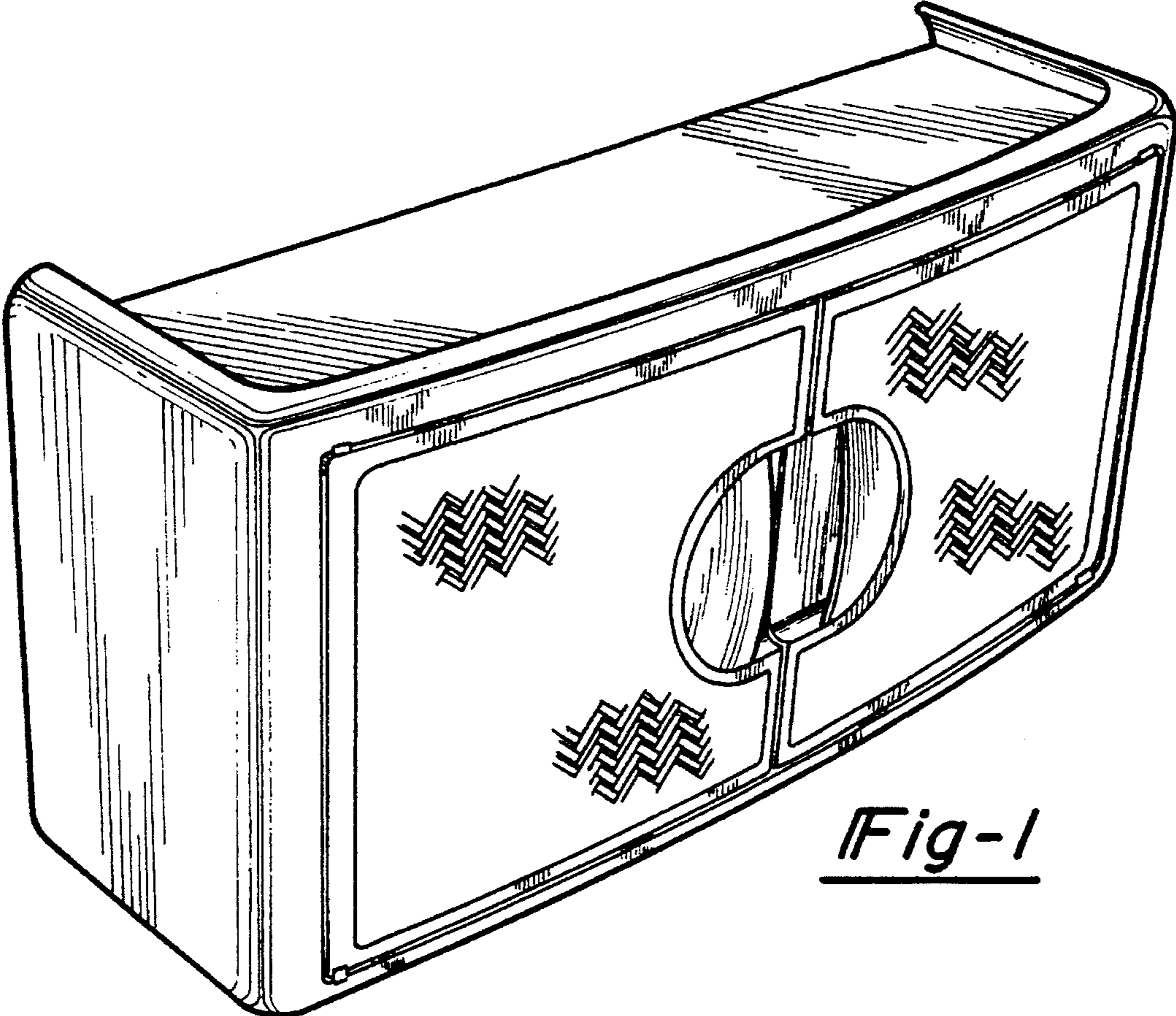

Fig-1

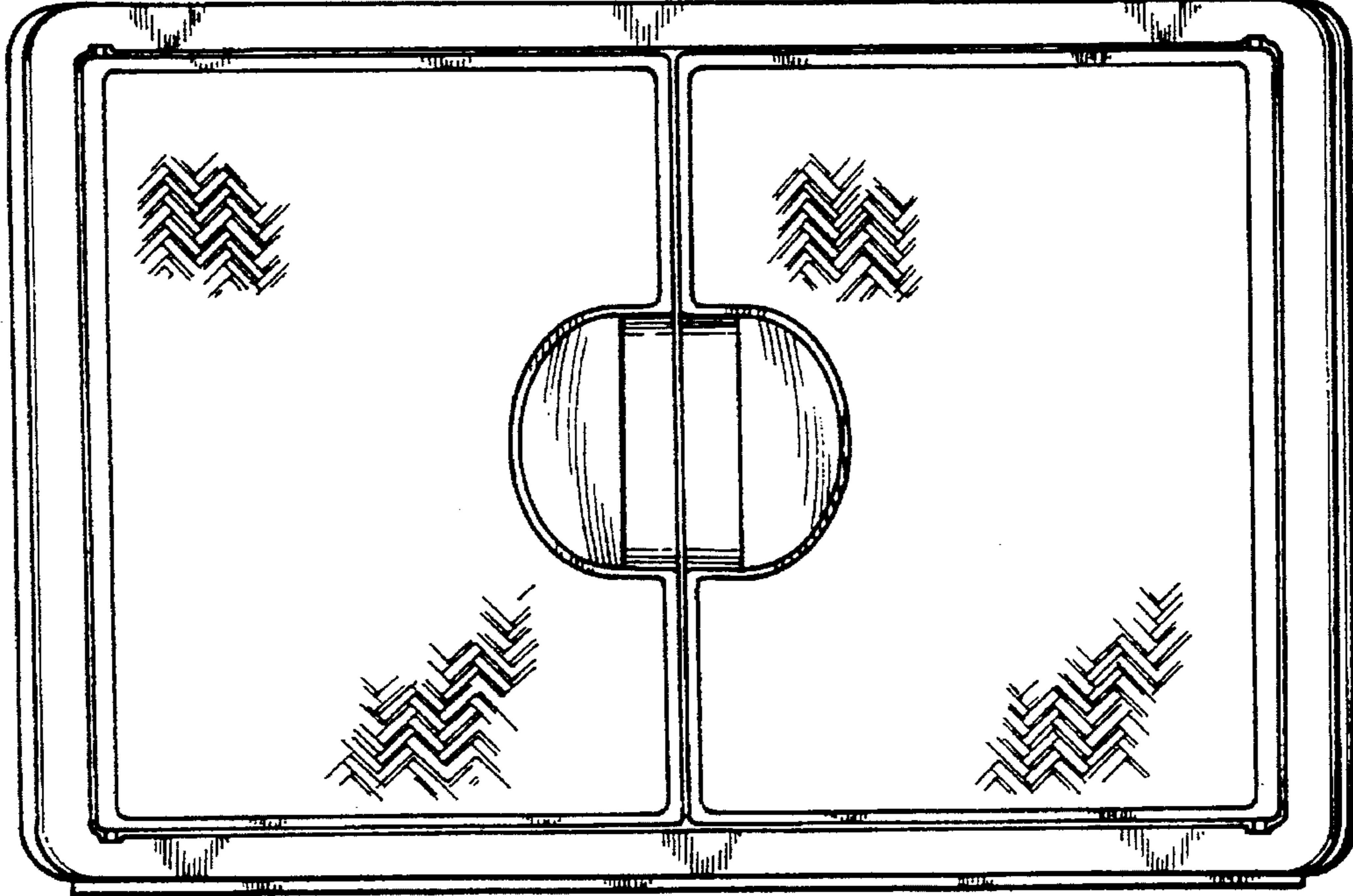

Fig-2

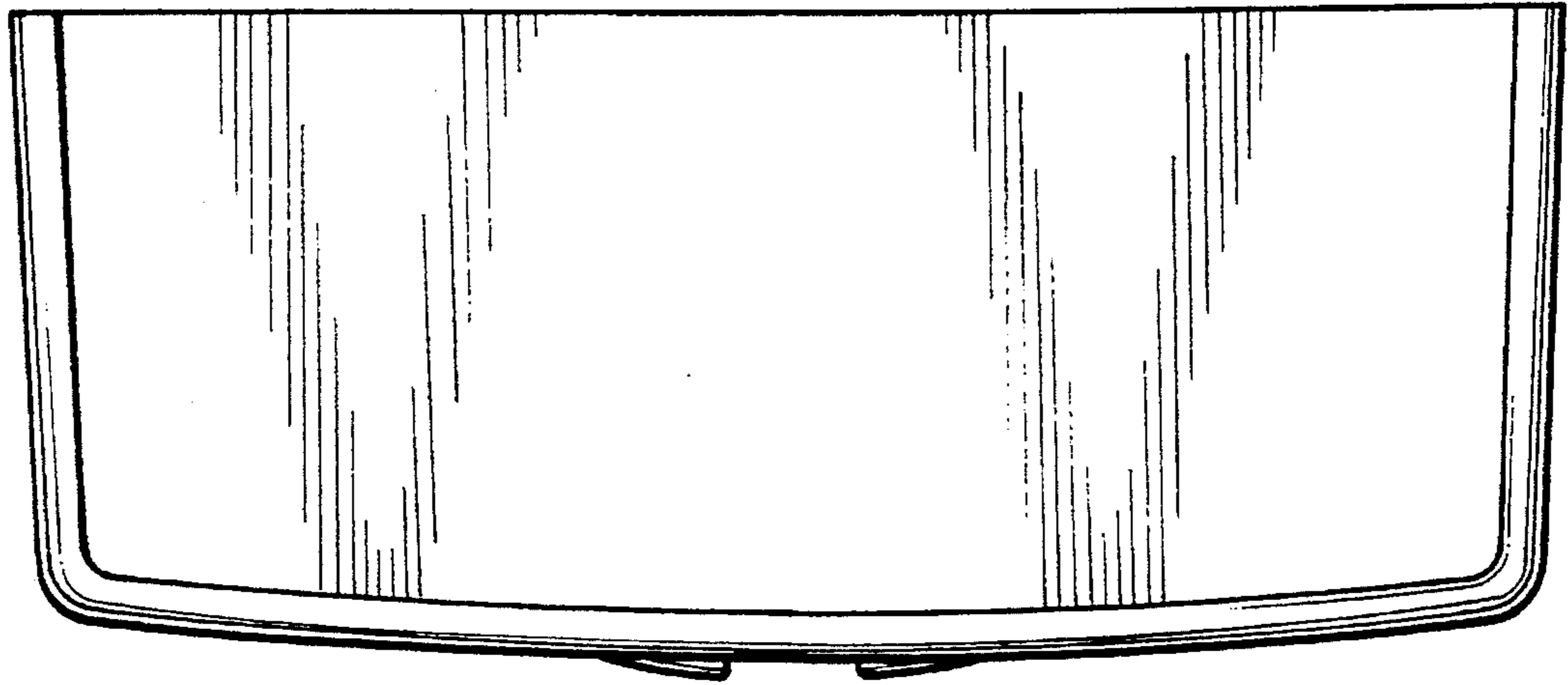

Fig-3

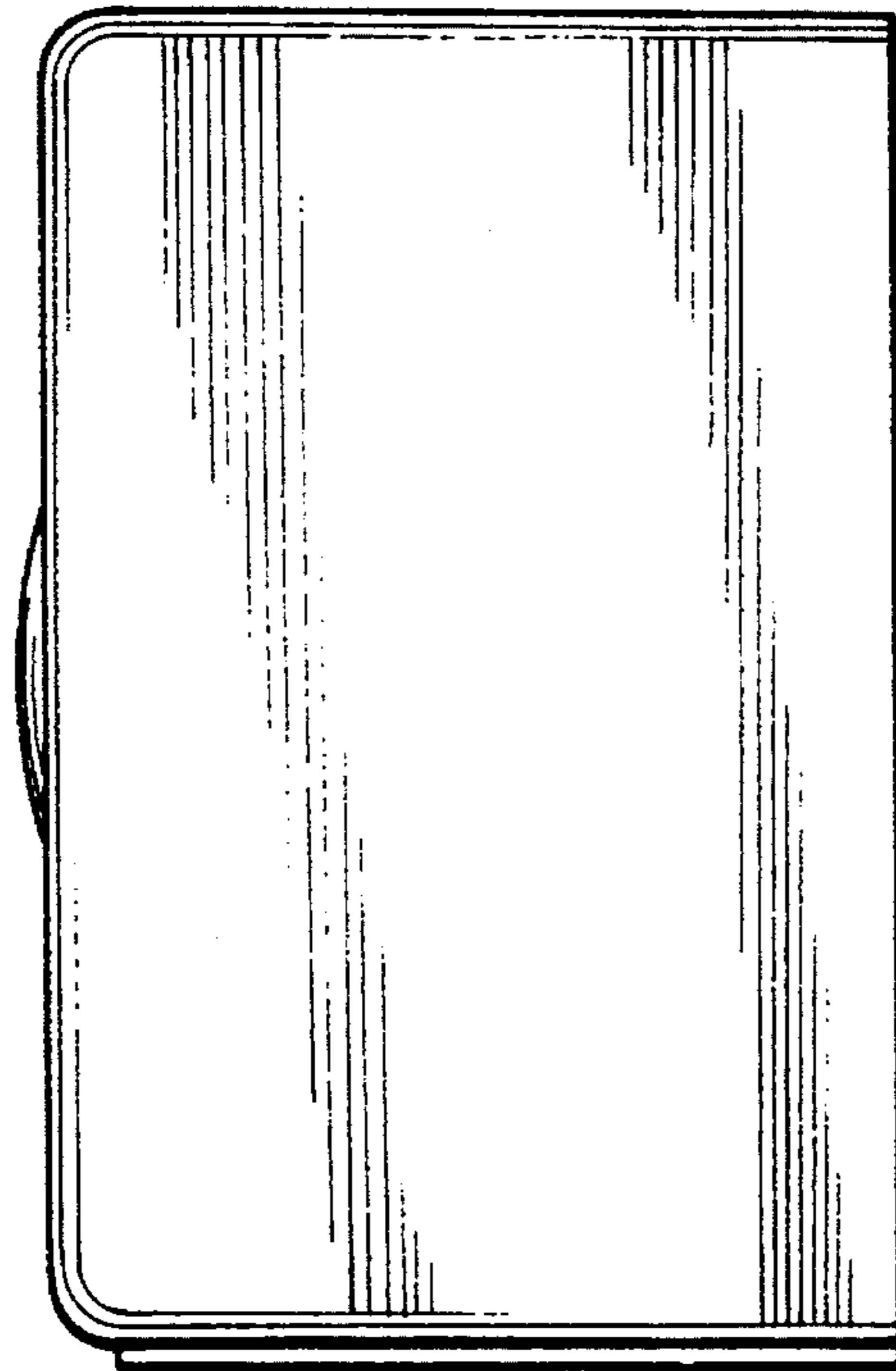

Fig-4

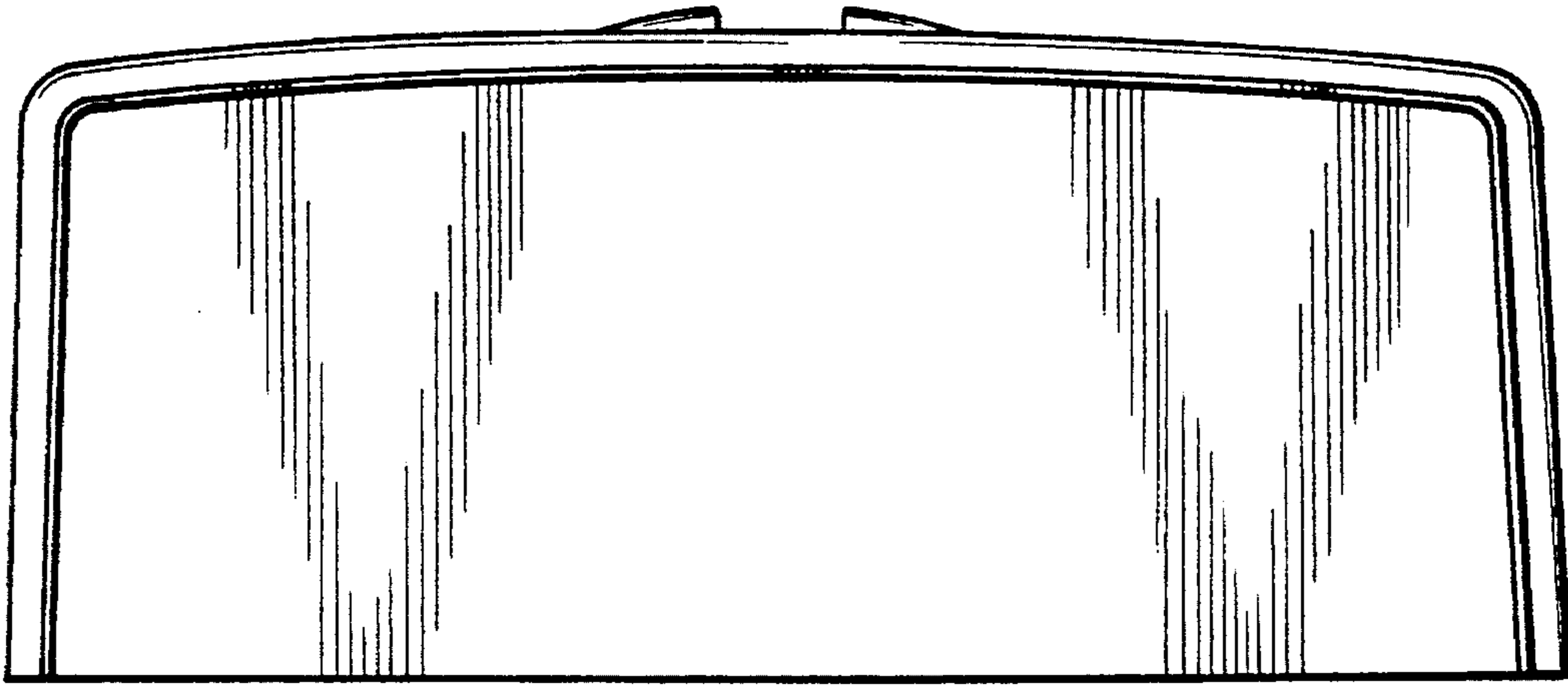

Fig-5

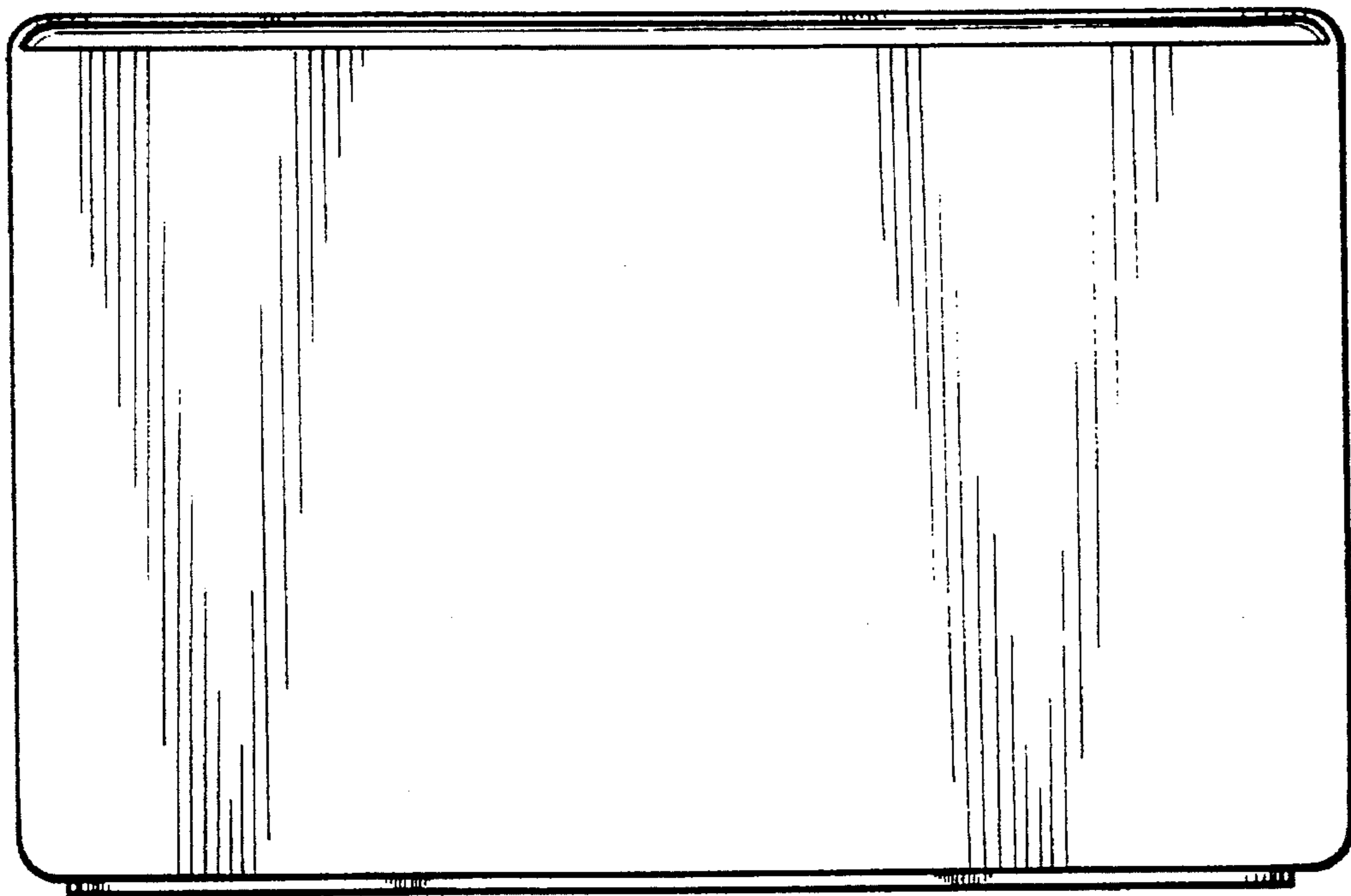

Fig-6