



US00D365630S

**United States Patent** [19]  
**Sullivan**

[11] **Patent Number: Des. 365,630**

[45] **Date of Patent: \*\*Dec. 26, 1995**

[54] **VENTED NEEDLE**

[76] Inventor: **James Sullivan**, P.O. Box 1799, Ojai,  
Calif. 93024

[\*\*] Term: **14 Years**

[21] Appl. No.: **11,210**

[22] Filed: **Jul. 30, 1993**

[52] U.S. Cl. .... **D24/112; D24/130**

[58] Field of Search ..... D24/112, 130;  
604/263, 198, 192, 162, 171, 280, 403,  
411, 412, 413

[56] **References Cited**

**U.S. PATENT DOCUMENTS**

D. 272,850	2/1984	Kulle .....	D24/112
D. 321,250	10/1991	Jepson et al. ....	D24/112
D. 321,252	10/1991	Jepson et al. ....	D24/112
D. 358,464	5/1995	Anderson .....	D24/112
2,833,281	5/1958	Krug .....	604/411 X
2,954,768	10/1960	Hamilton .....	604/411 X

2,989,053	6/1961	Hamilton .....	604/411 X
4,411,661	10/1983	Kersten .....	604/411
4,624,667	11/1986	Rutnarak .....	604/413 X

*Primary Examiner*—Cathy Anne MacCormac  
*Assistant Examiner*—I. Simmons  
*Attorney, Agent, or Firm*—Robert M. Wallace; Michaelson & Wallace

[57] **CLAIM**

The ornamental design for a vented needle, as shown.

**DESCRIPTION**

FIG. 1 is a perspective view of the claimed invention;  
FIG. 2 is an enlarged fragmentary view of the tip portion of  
the claimed design;  
FIG. 3 is a front view of the claimed invention;  
FIG. 4 is a side view of the claimed invention;  
FIG. 5 is a side view of the claimed design; and,  
FIG. 6 is a back view of the claimed invention.

**1 Claim, 2 Drawing Sheets**

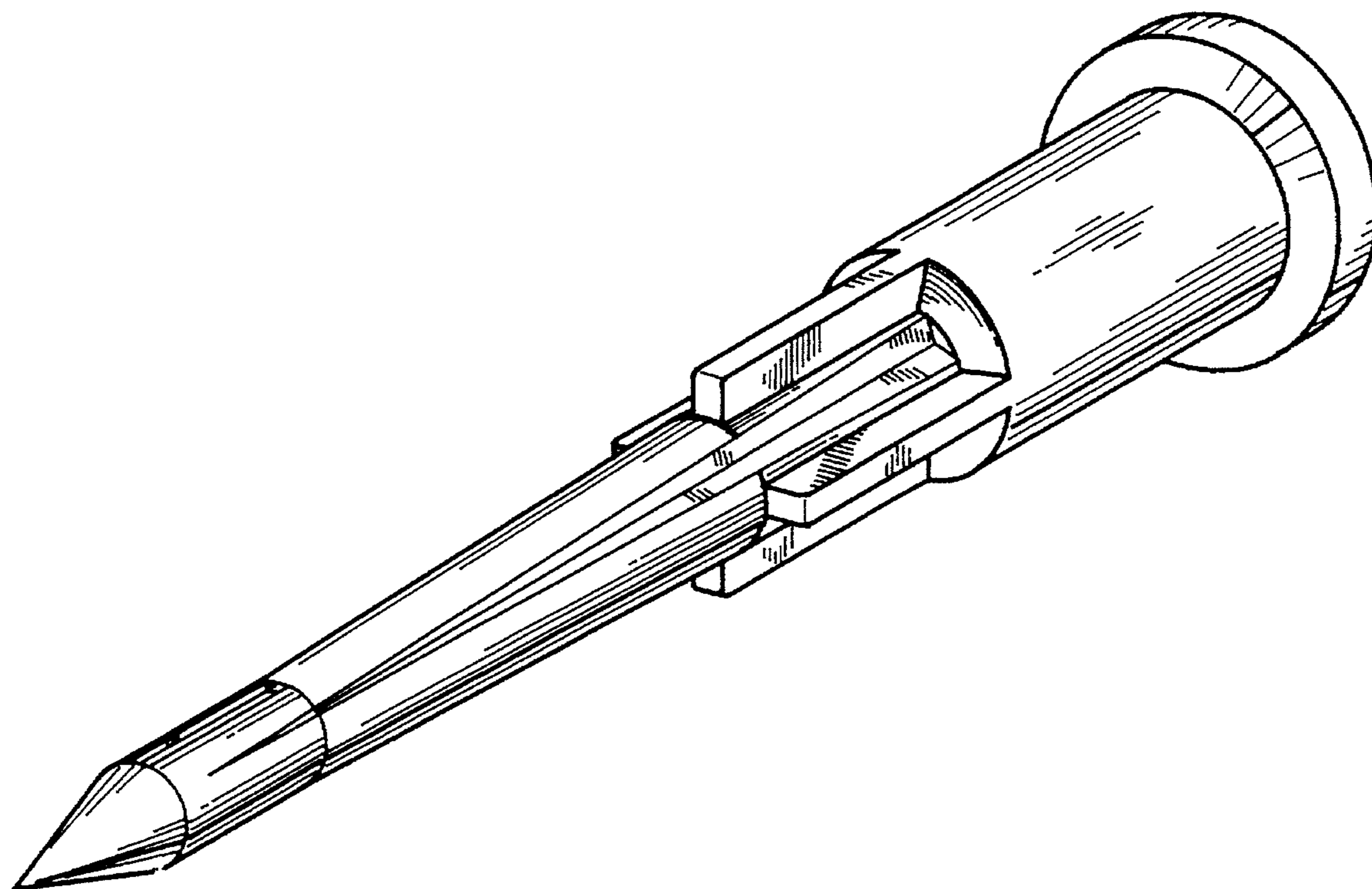

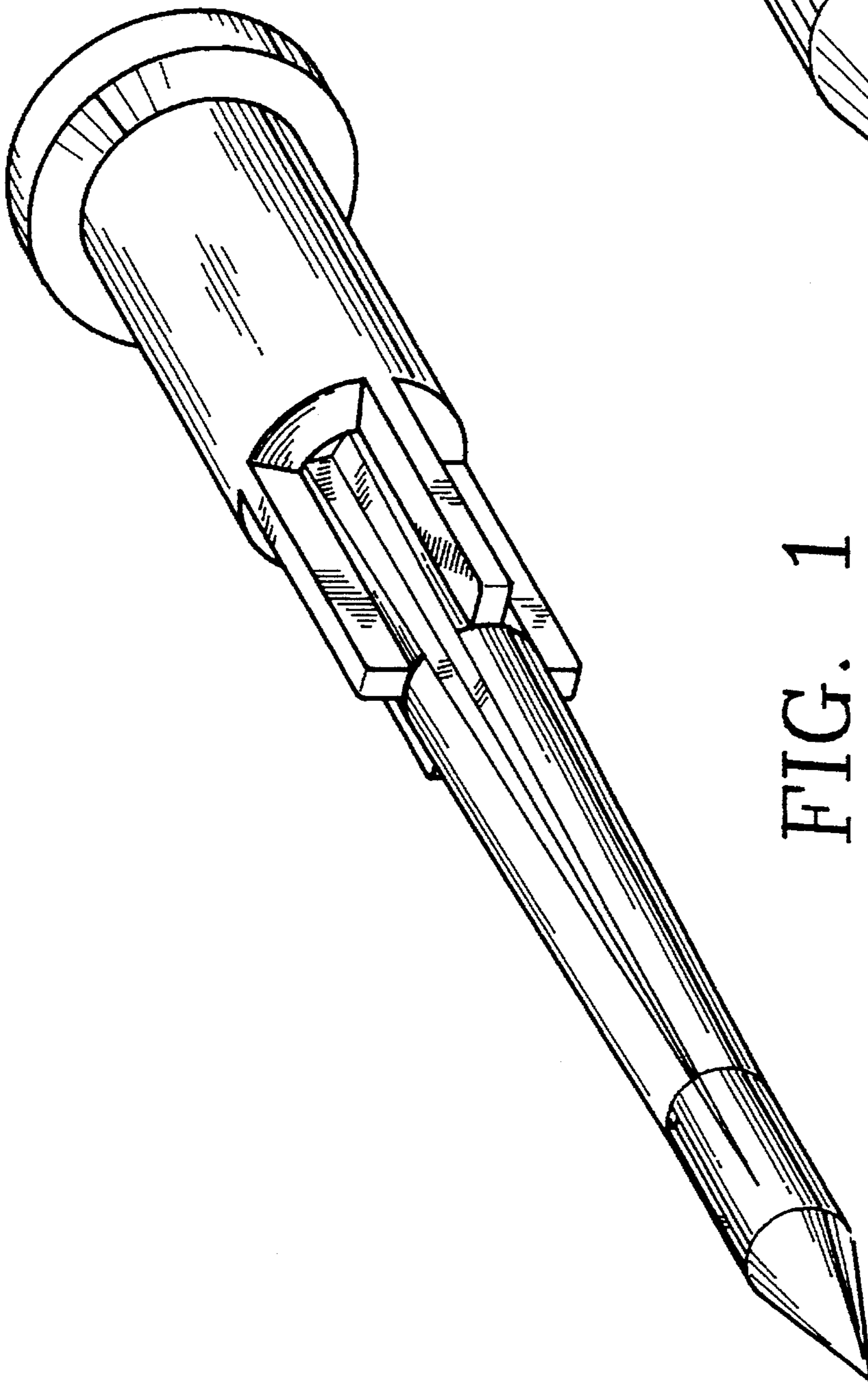

FIG. 1

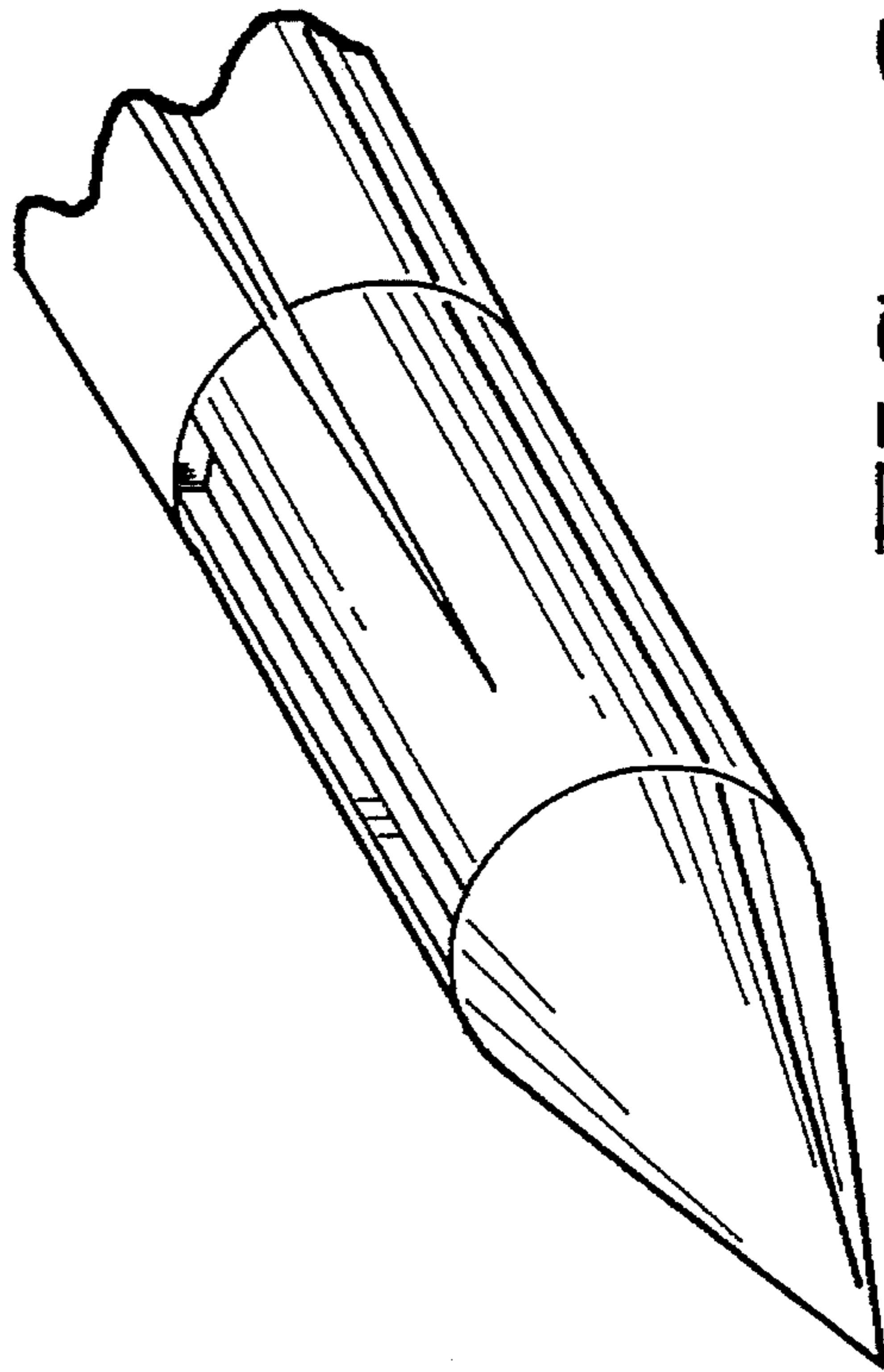

FIG. 2

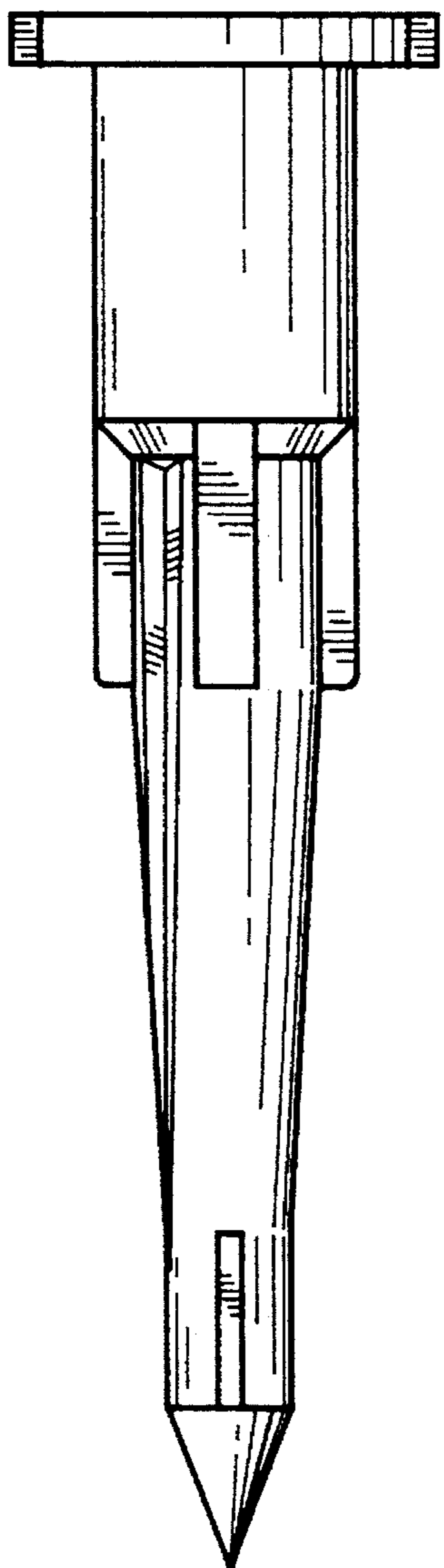

FIG. 4

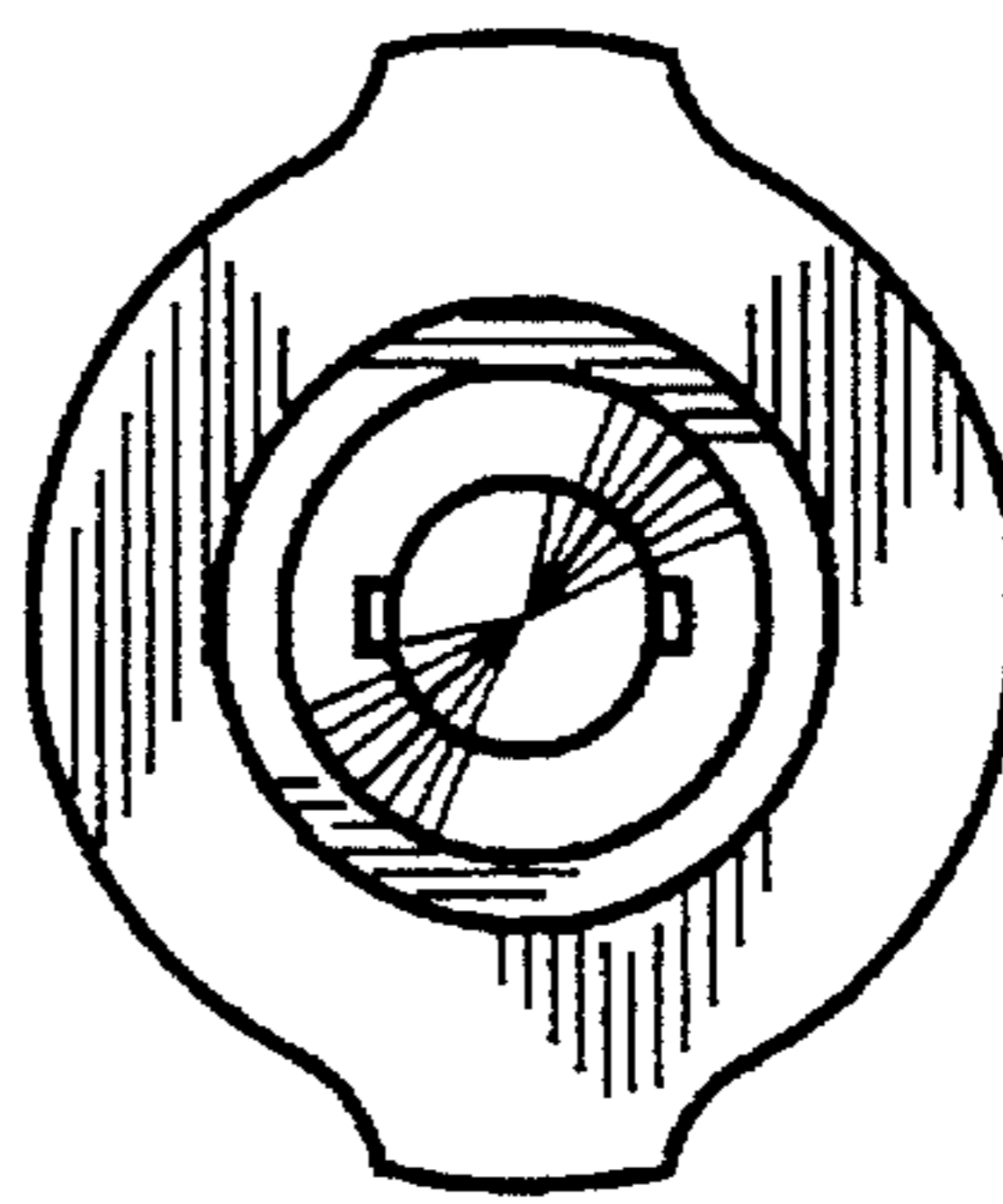

FIG. 6

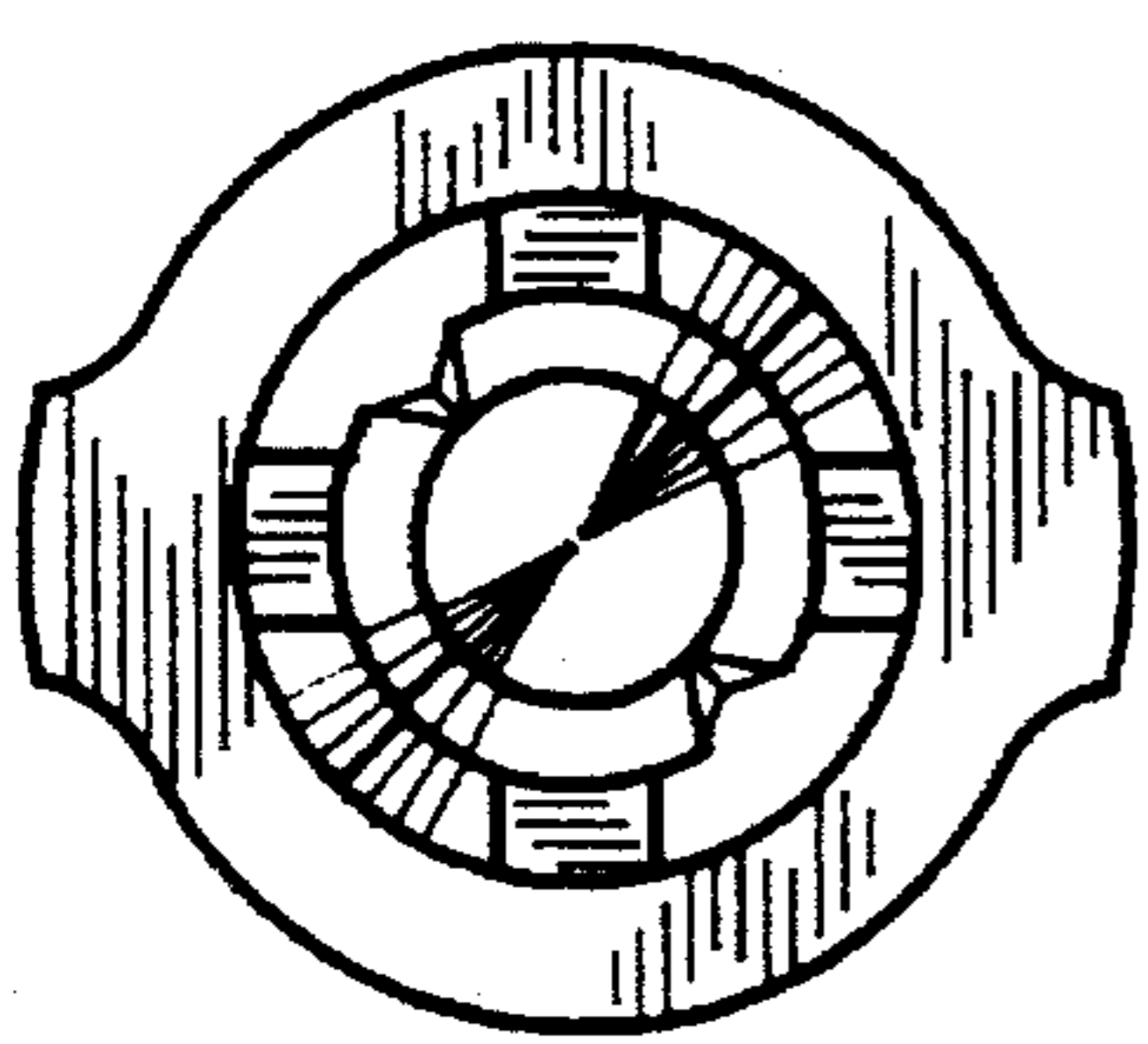

FIG. 3

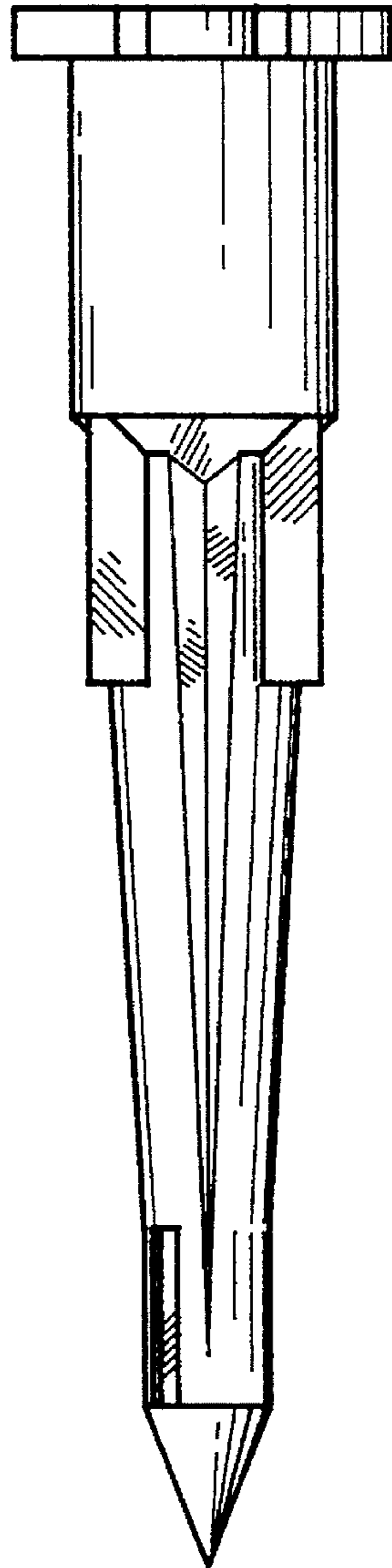

FIG. 5