



US00D365615S

United States Patent [19]
Shimatani

[11] **Patent Number: Des. 365,615**

[45] **Date of Patent: **Dec. 26, 1995**

[54] **HEAD FOR A GOLF PUTTER**

4,712,798 12/1987 Preato 273/167 A X
5,344,151 9/1994 Anderson et al. 273/171

[76] Inventor: **Akio Shimatani**, 9-9, Kamikariyakita,
Ako-city, Hyogo 678-02, Japan

Primary Examiner—Terry A. Wallace
Assistant Examiner—Mitchell I. Siegel
Attorney, Agent, or Firm—Birch, Stewart, Kolasch & Birch

[**] Term: **14 Years**

[57] **CLAIM**

[21] Appl. No.: **28,562**

The ornamental design for a head for a golf putter, as shown and described.

[22] Filed: **Sep. 19, 1994**

[52] U.S. Cl. **D21/219**

DESCRIPTION

[58] Field of Search D21/217-219;
273/167-175

FIG. 1 is a front elevational view of a head for a golf putter showing my new design;
FIG. 2 is a right side elevational view thereof;
FIG. 3 is a left side elevational view thereof;
FIG. 4 is a rear elevational view thereof;
FIG. 5 is a top plan view thereof;
FIG. 6 is a bottom plan view thereof; and,
FIG. 7 is a perspective view thereof.

[56] **References Cited**

U.S. PATENT DOCUMENTS

D. 234,961	4/1975	Swash	D21/217
D. 251,310	3/1979	Paulin	D21/219
D. 344,564	2/1994	Oakleaf	D21/219
3,459,426	8/1969	Sherwood	D21/219 X
4,141,556	2/1979	Paulin	273/167 A X

1 Claim, 4 Drawing Sheets

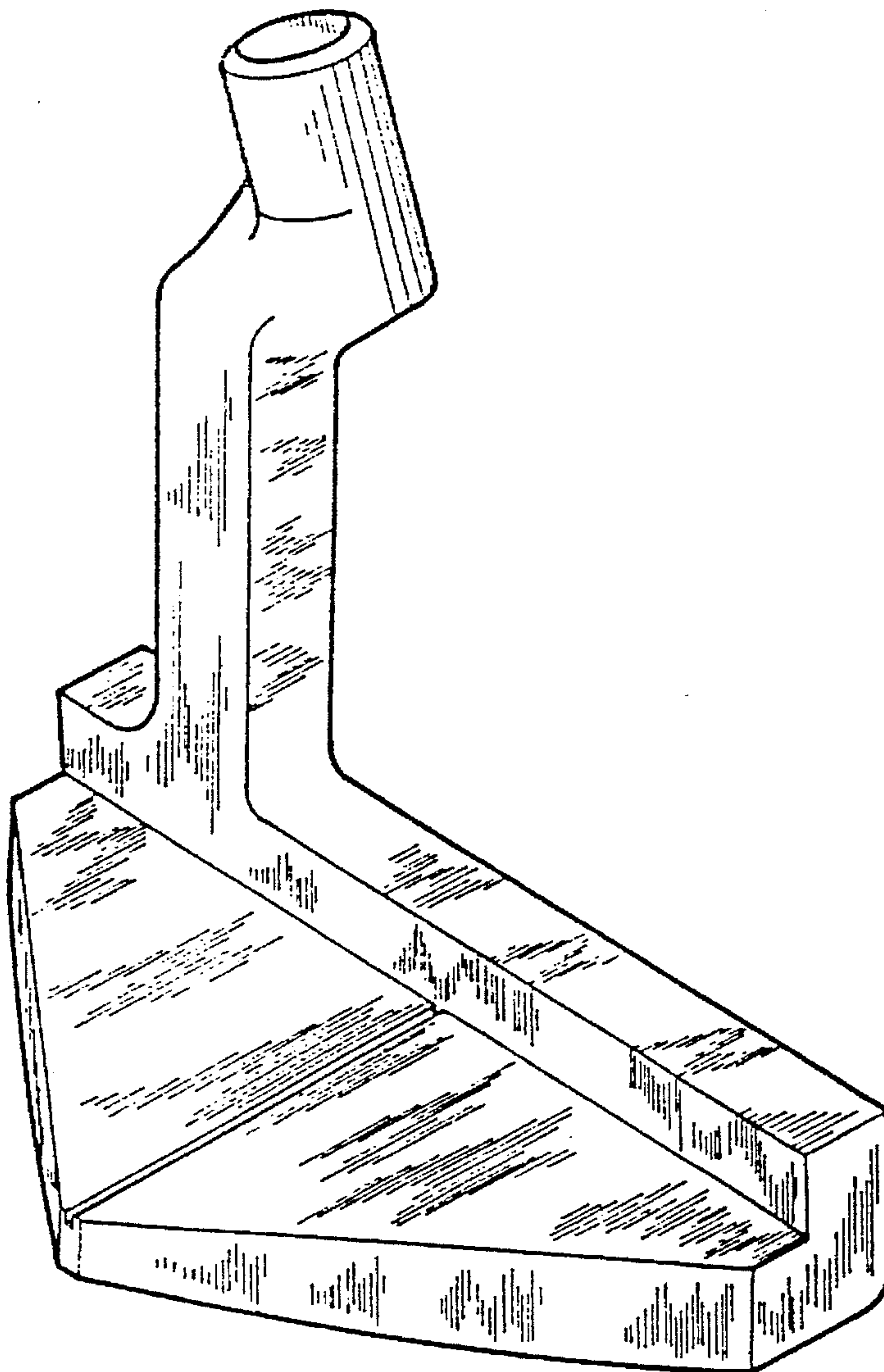

FIG. 1

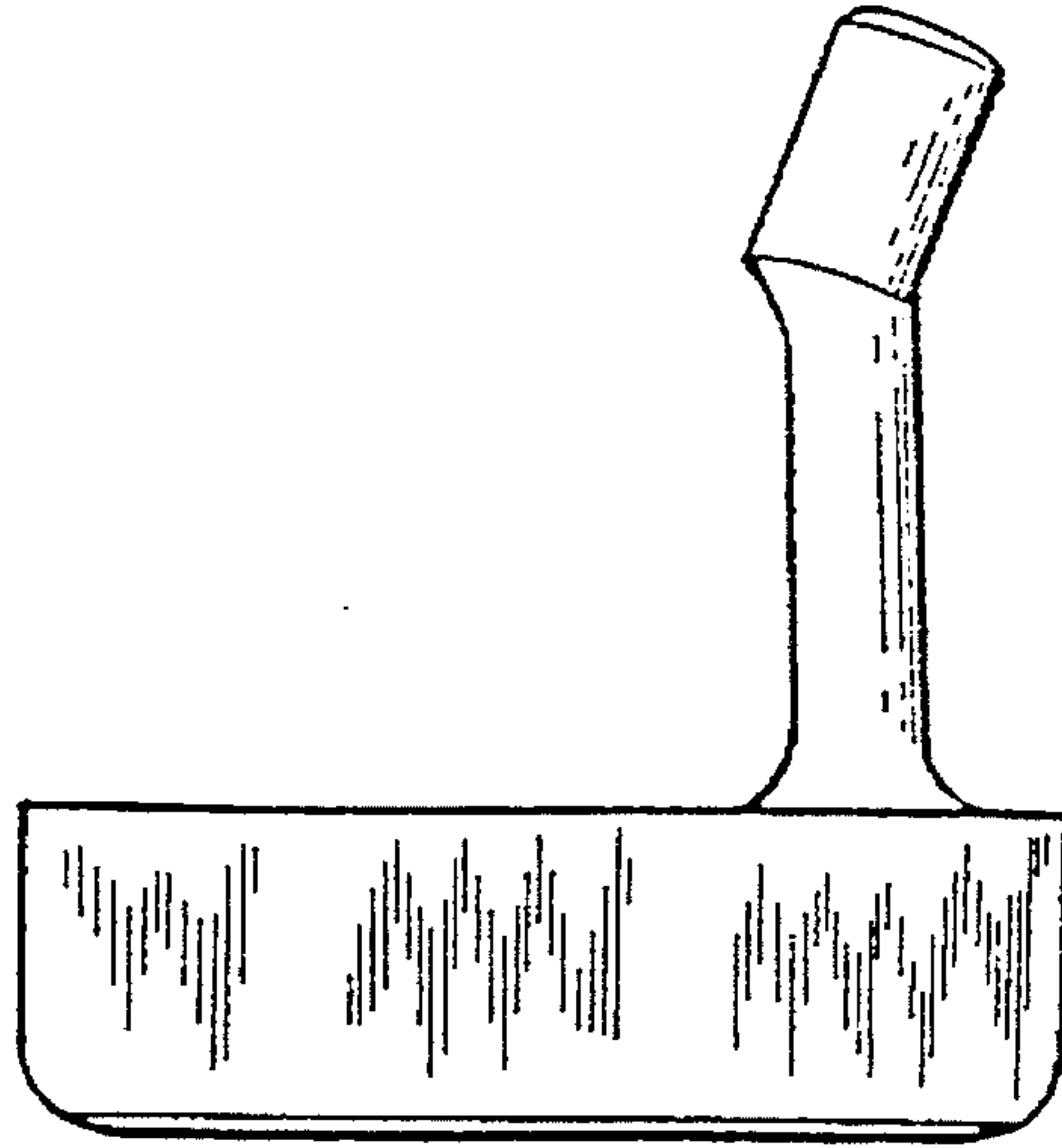

FIG. 2

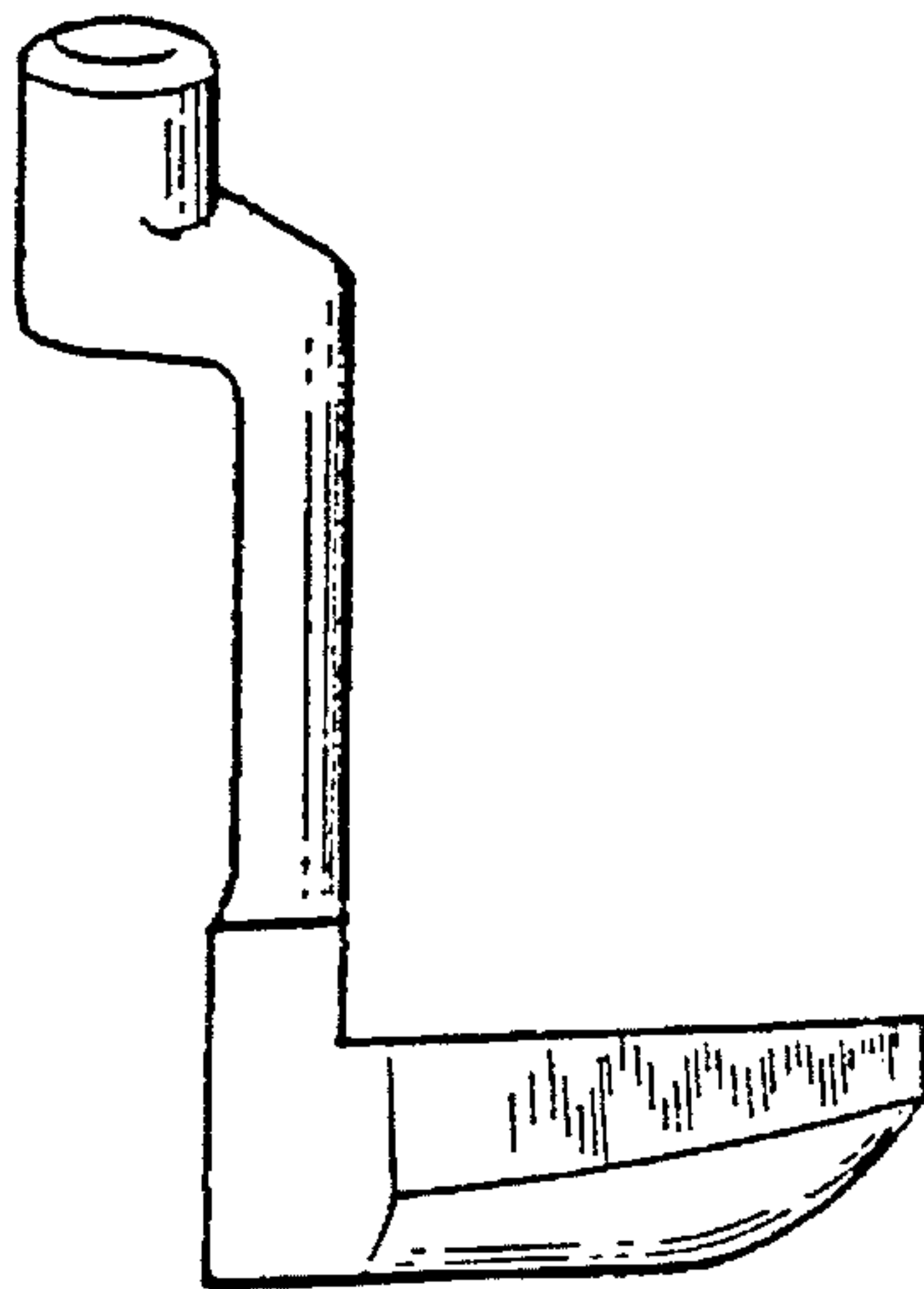

FIG. 3

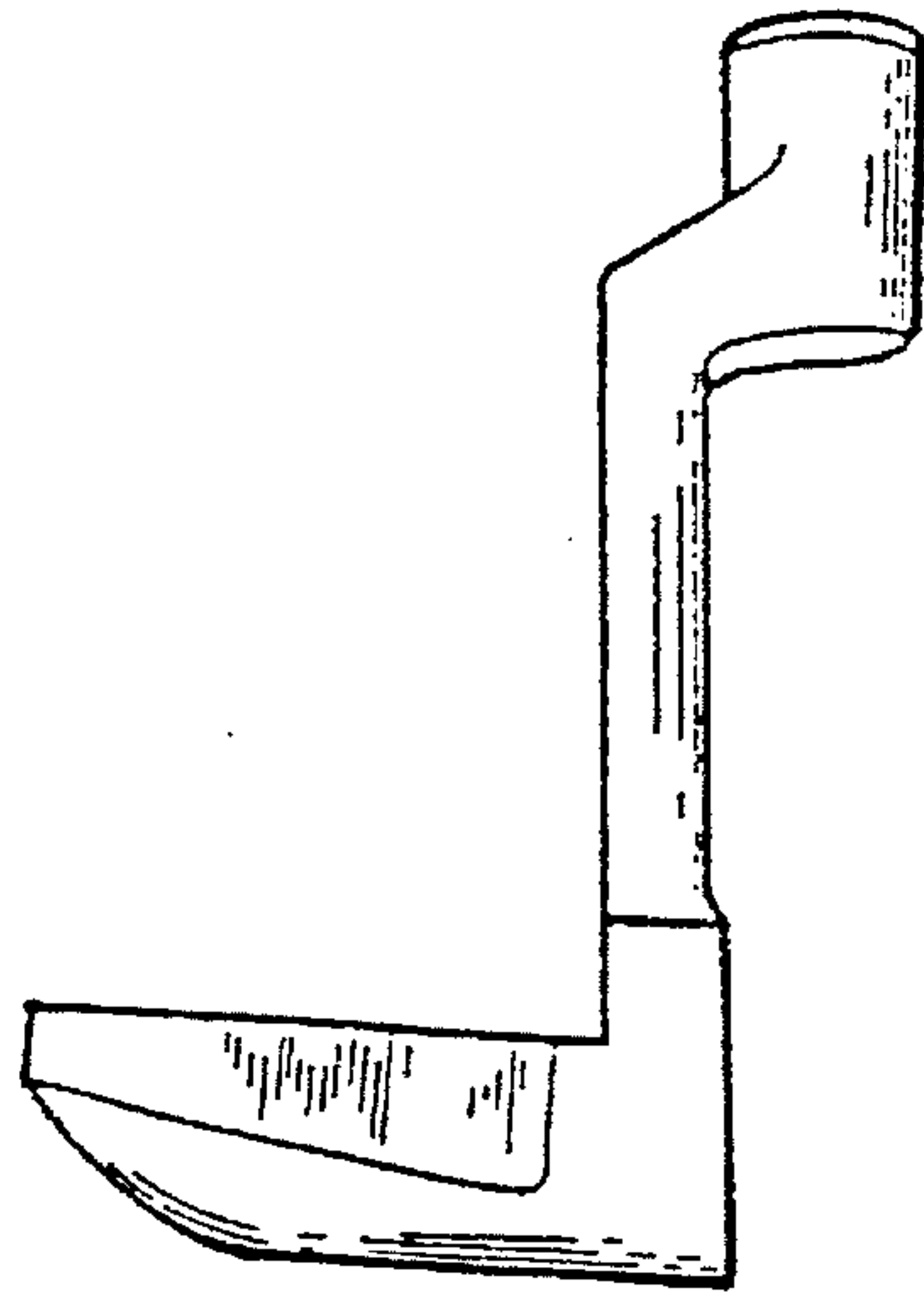

FIG. 4

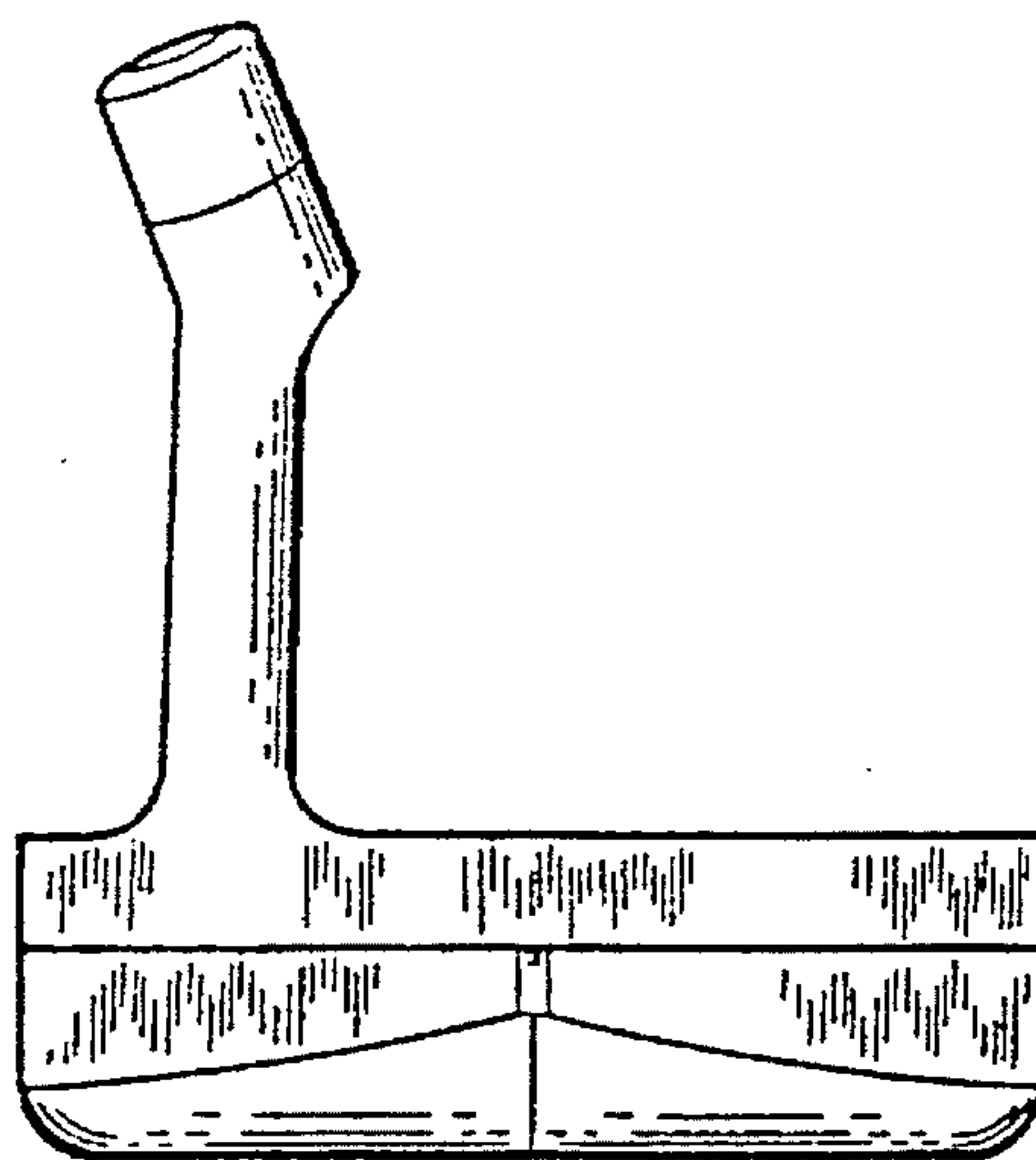

FIG. 5

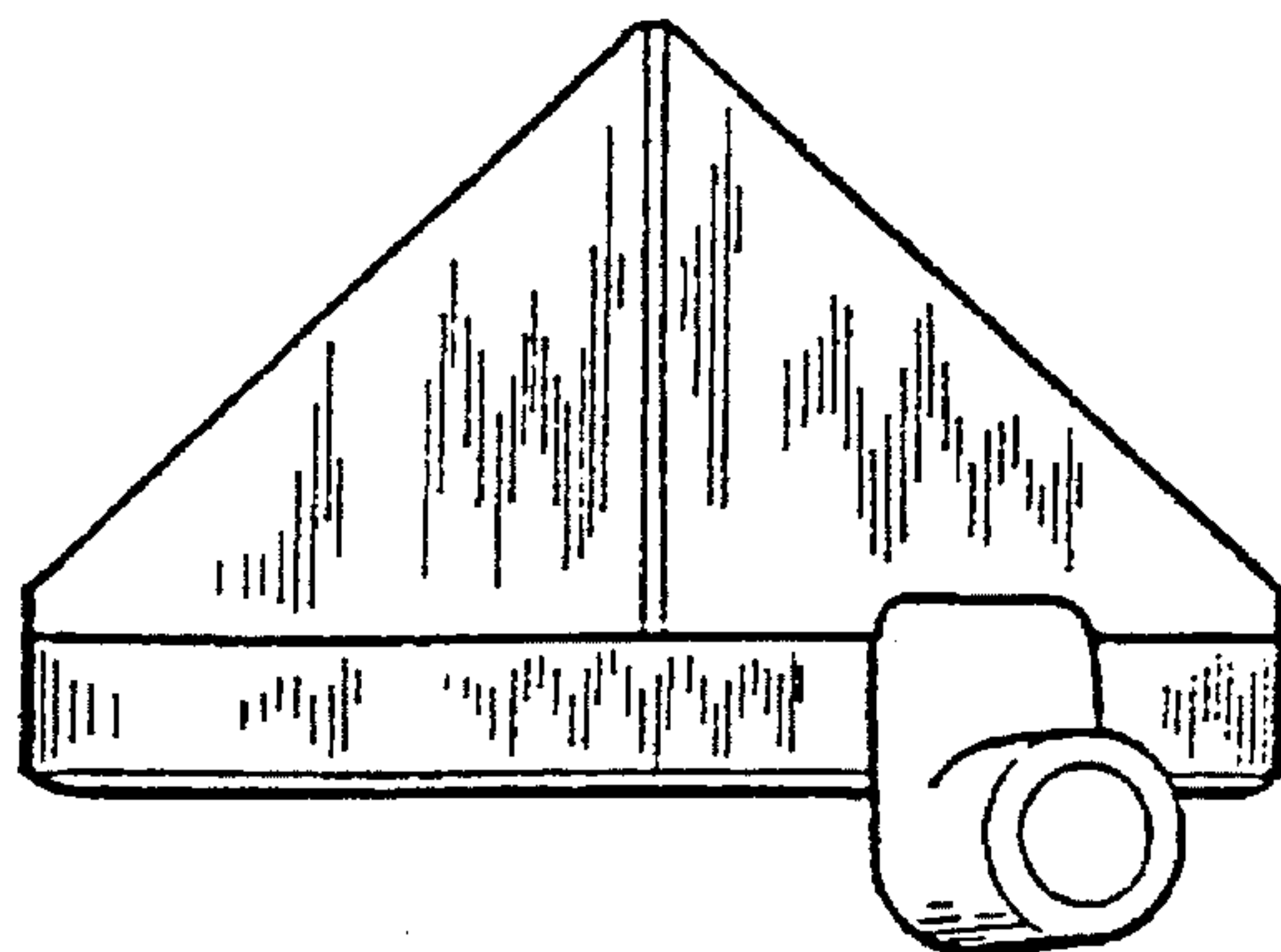

FIG. 6

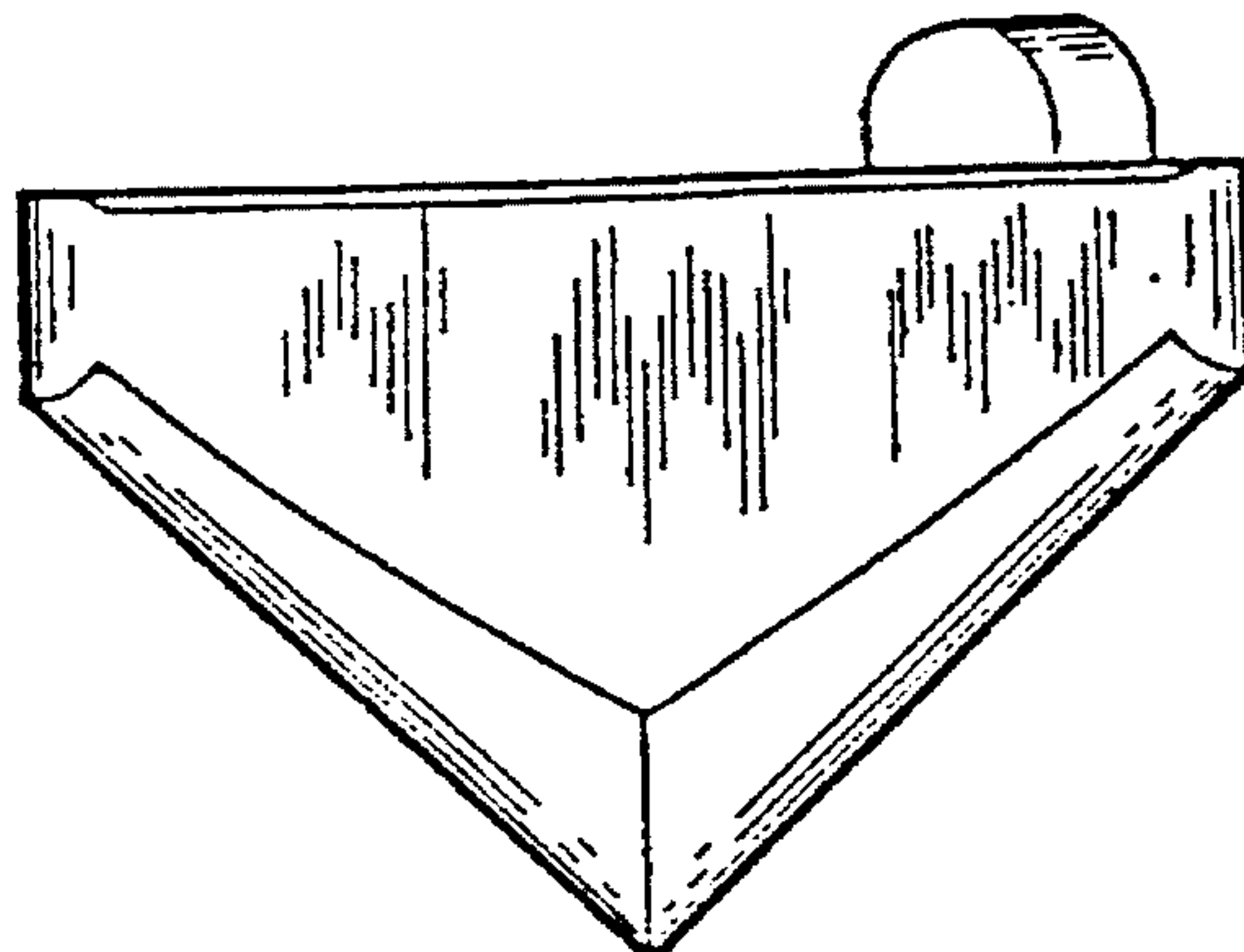

FIG. 7

