



US00D365597S

United States Patent [19]

[11] Patent Number: **Des. 365,597**

Patzak et al.

[45] Date of Patent: ****Dec. 26, 1995**

[54] **HAND HELD LABELER**

0286997 10/1988 European Pat. Off. 156/DIG. 49
0146791 11/1981 Japan 400/288

[75] Inventors: **Peter Patzak**, Mühlthal; **Heinrich Volk**,
Beerfelden-Gammelsbach, both of
Germany

Primary Examiner—Cathy Anne MacCormac
Attorney, Agent, or Firm—Nils H. Ljungman & Associates

[73] Assignee: **Esselte Meto International
Produktions GmbH**, Heppenheim,
Germany

[57] CLAIM

[**] Term: **14 Years**

The ornamental design for a hand-held labeler, as shown and described.

[21] Appl. No.: **14,551**

DESCRIPTION

[22] Filed: **Oct. 22, 1993**

[30] Foreign Application Priority Data

FIG. 1 is a perspective view of a hand held labeler showing our new design;
FIG. 2 is a side elevational view thereof;
FIG. 3 is the opposite side of FIG. 2;
FIG. 4 is a top plan view thereof;
FIG. 5 is a bottom plan view thereof;
FIG. 6 is a front elevational view thereof;
FIG. 7 is a rear elevational view thereof;
FIG. 8 is an additional perspective view from the bottom, side and front thereof;
FIG. 9 is a perspective view of a second embodiment of FIG. 1;
FIG. 10 is a side elevational view of FIG. 9;
FIG. 11 is the opposite side of FIG. 10;
FIG. 12 is a top plan view of FIG. 9;
FIG. 13 is a bottom plan view of FIG. 9;
FIG. 14 is a front elevational view of FIG. 9;
FIG. 15 is a rear elevational view of FIG. 9; and,
FIG. 16 is an additional perspective view from the bottom, side and front of FIG. 9.

Apr. 22, 1993 [DE] Germany M9303190

[52] U.S. Cl. **D18/19**

[58] Field of Search D18/14, 19, 52;
101/288; 156/384, DIG. 48, DIG. 49

[56] References Cited

U.S. PATENT DOCUMENTS

D. 269,527	6/1983	Becker	D18/19
D. 292,102	9/1987	Takahaski	D18/19
D. 316,105	4/1991	Hermann	D18/19
D. 347,238	5/1994	Patzak	D18/19
3,705,833	12/1972	Wada	156/354
3,890,188	6/1975	Sams	156/384
4,308,797	1/1982	Bicker et al.	156/384
4,724,034	2/1988	Bicker	156/384
4,986,874	1/1991	Kawada	156/DIG. 48

FOREIGN PATENT DOCUMENTS

0280877 9/1988 European Pat. Off. 156/DIG. 49

1 Claim, 16 Drawing Sheets

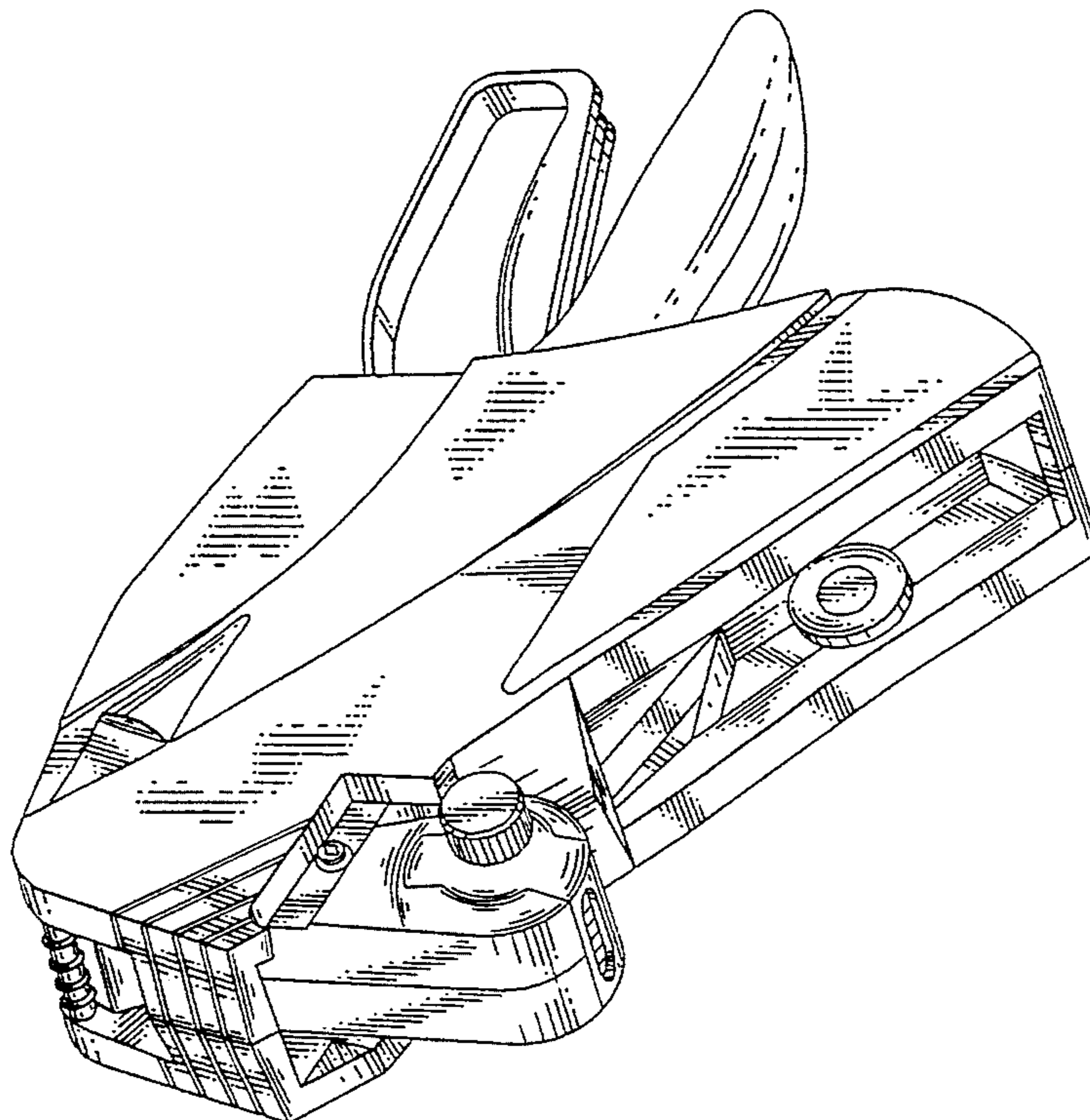

FIG. 1

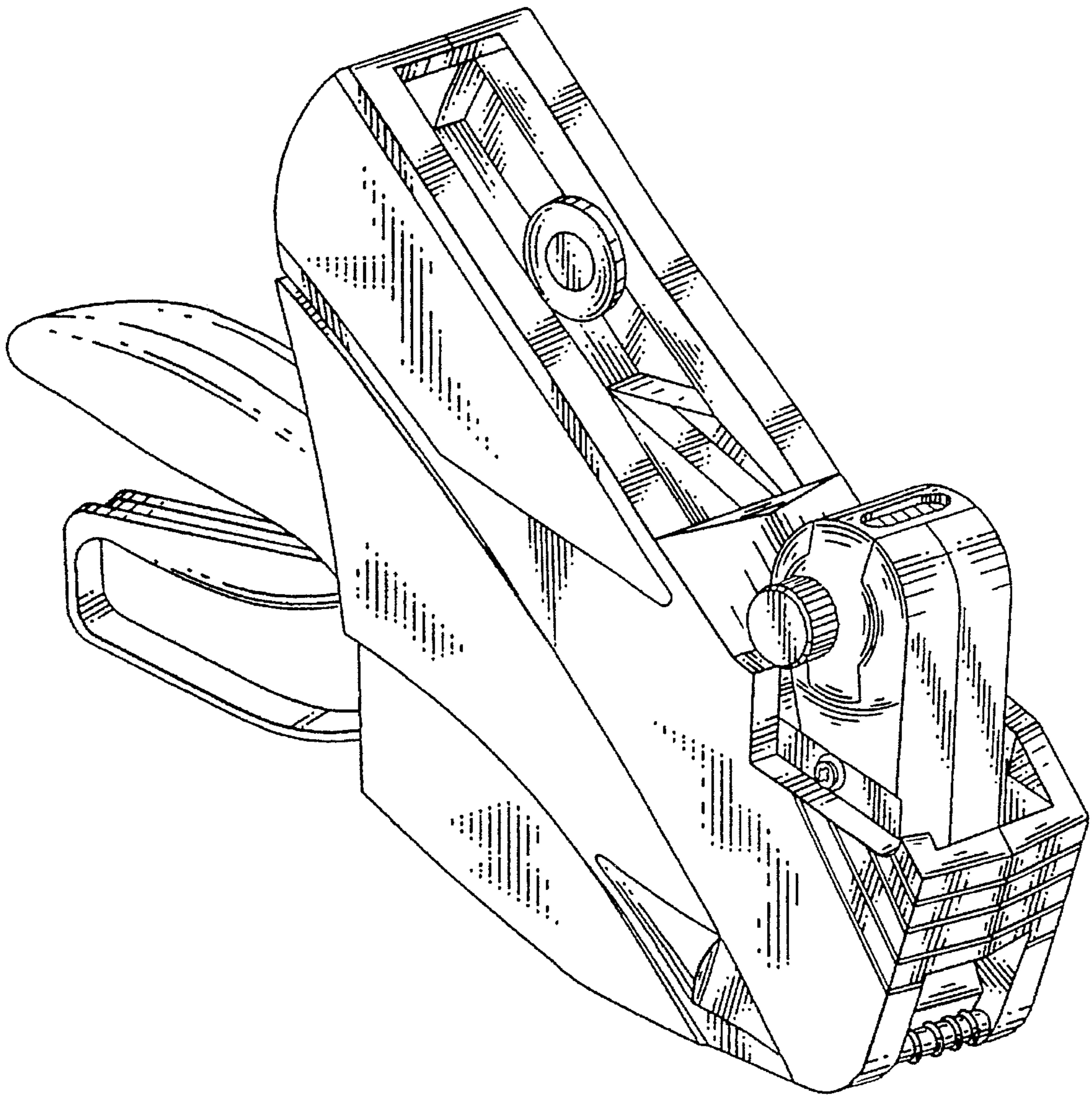
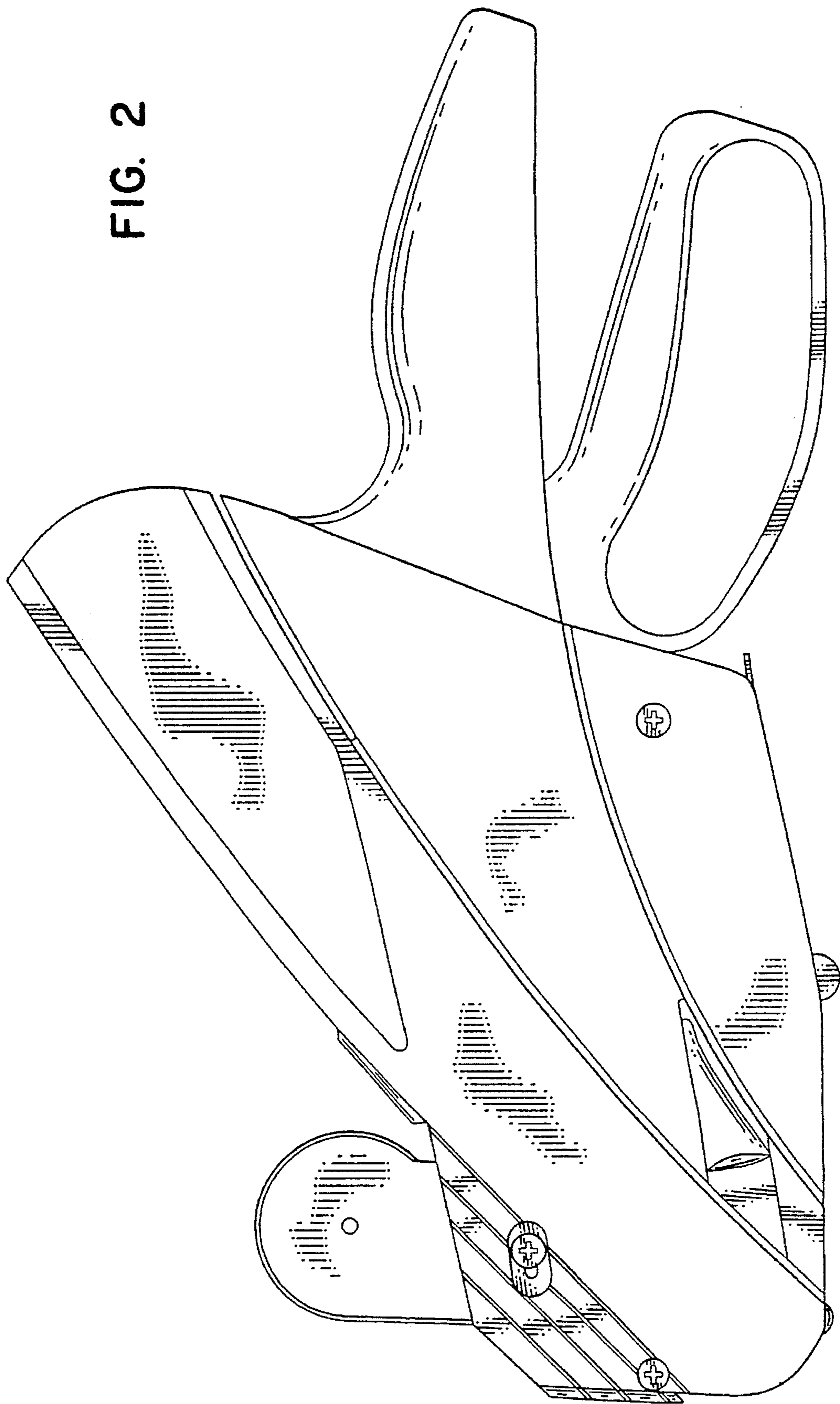

FIG. 2



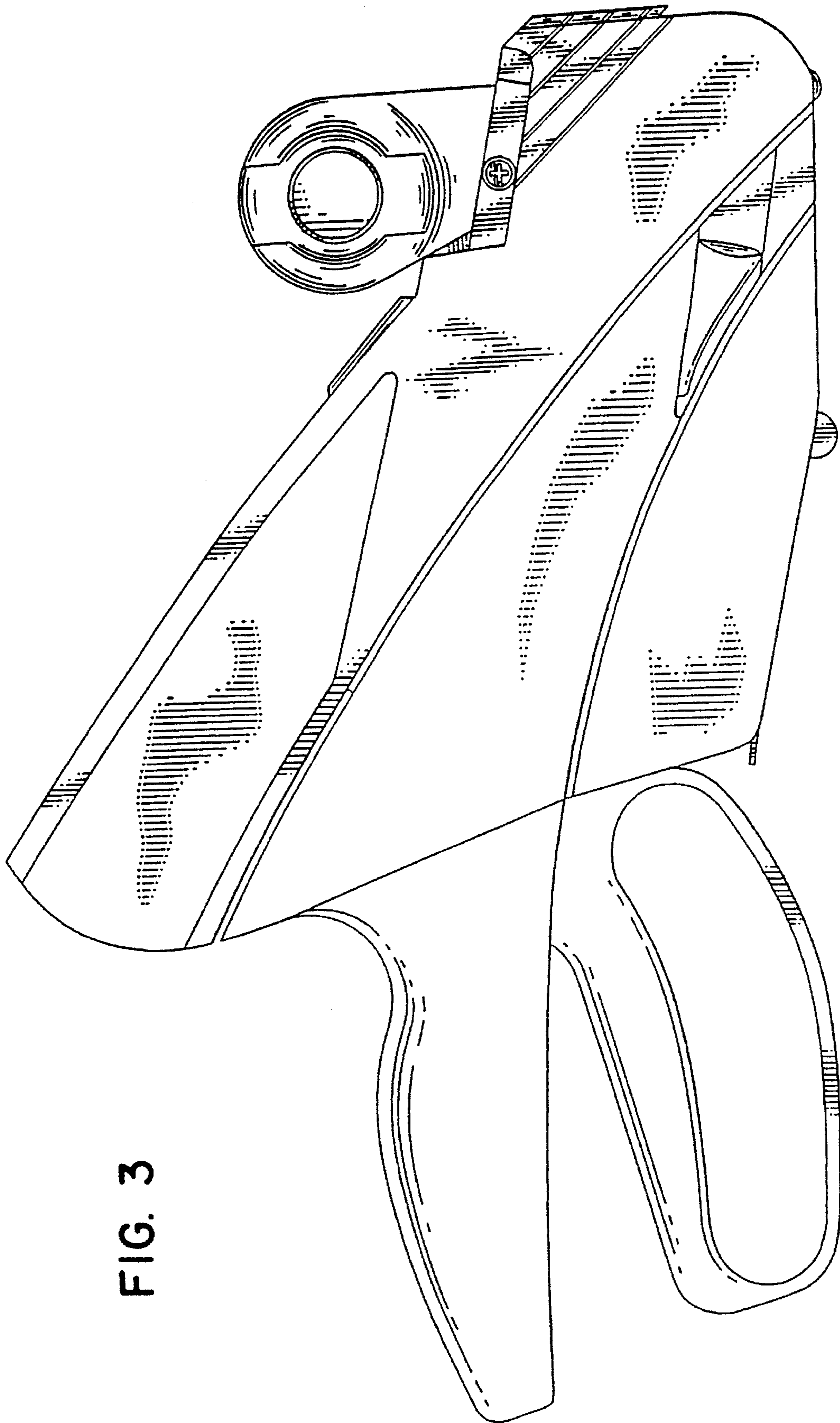

FIG. 3

FIG. 4

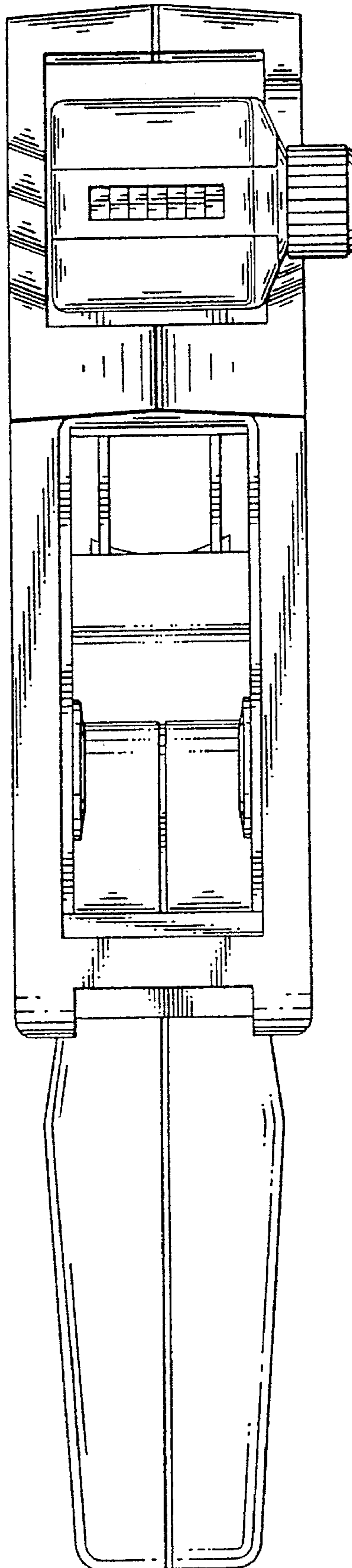

FIG. 5

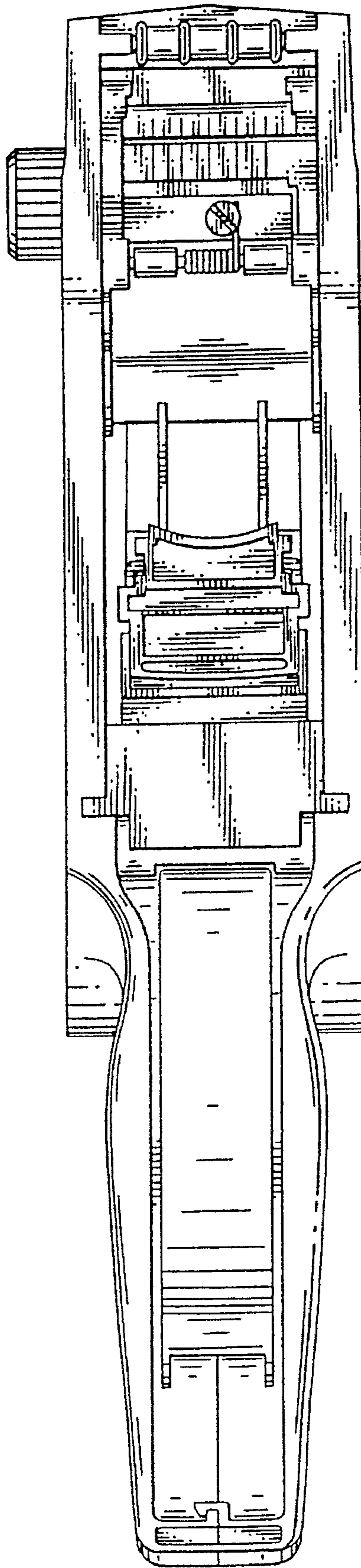

FIG. 6

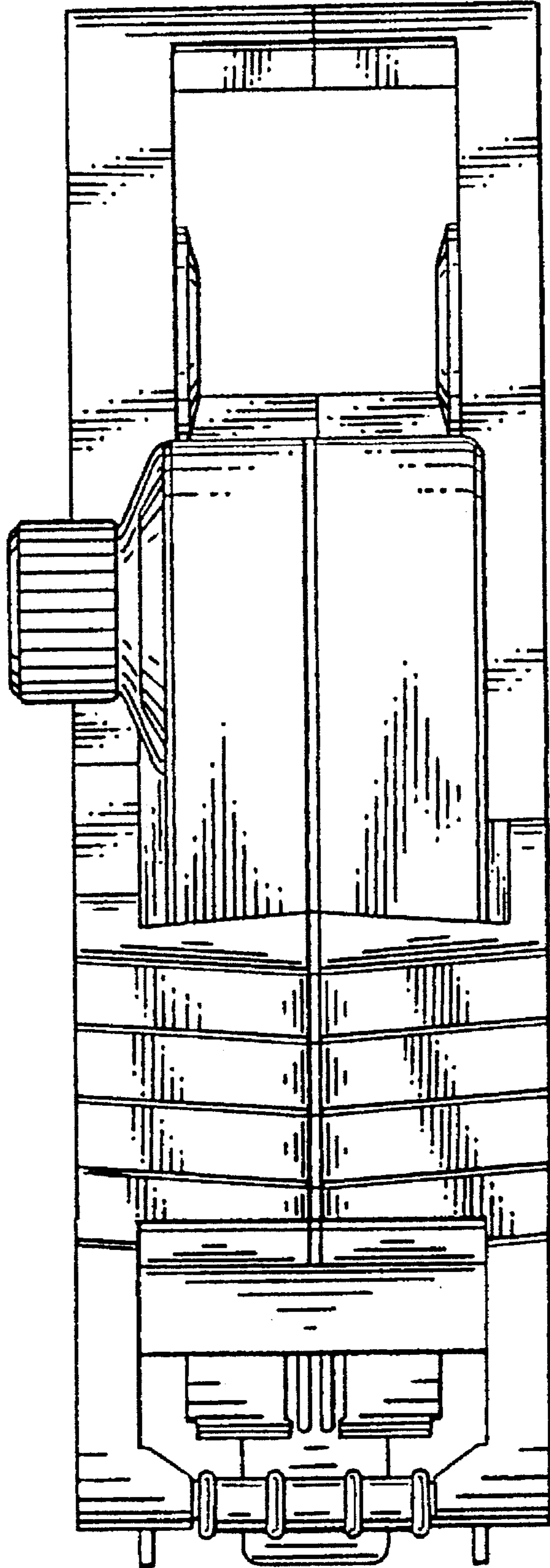
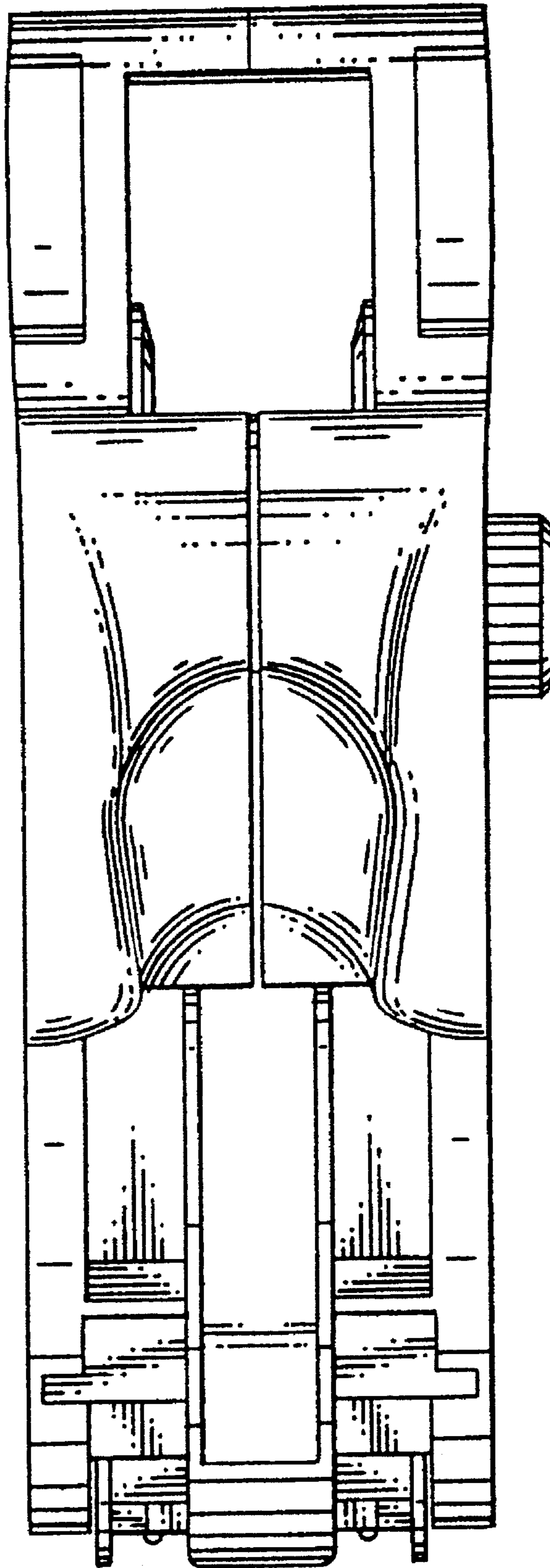

FIG. 7



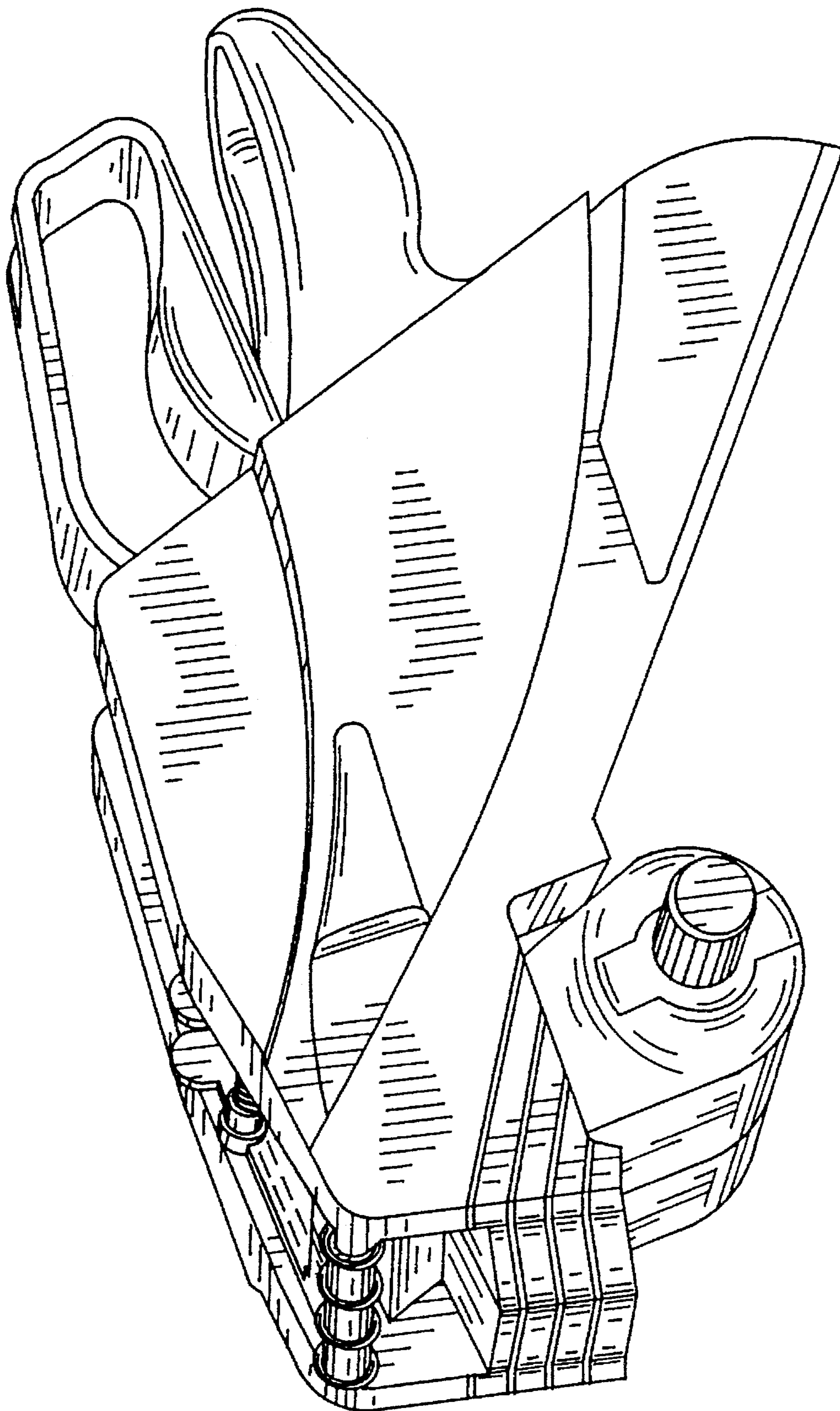

FIG. 8

FIG. 9

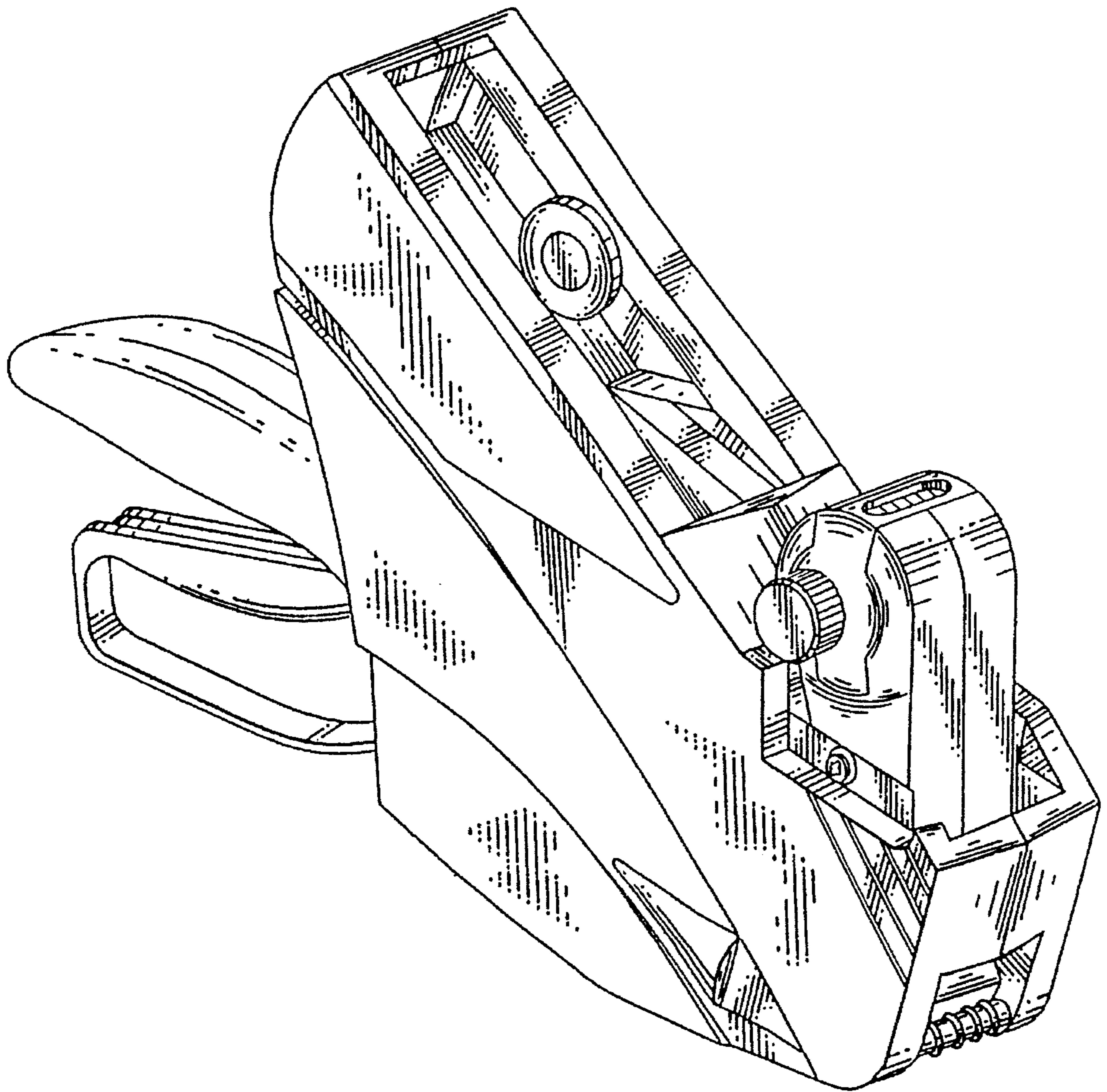
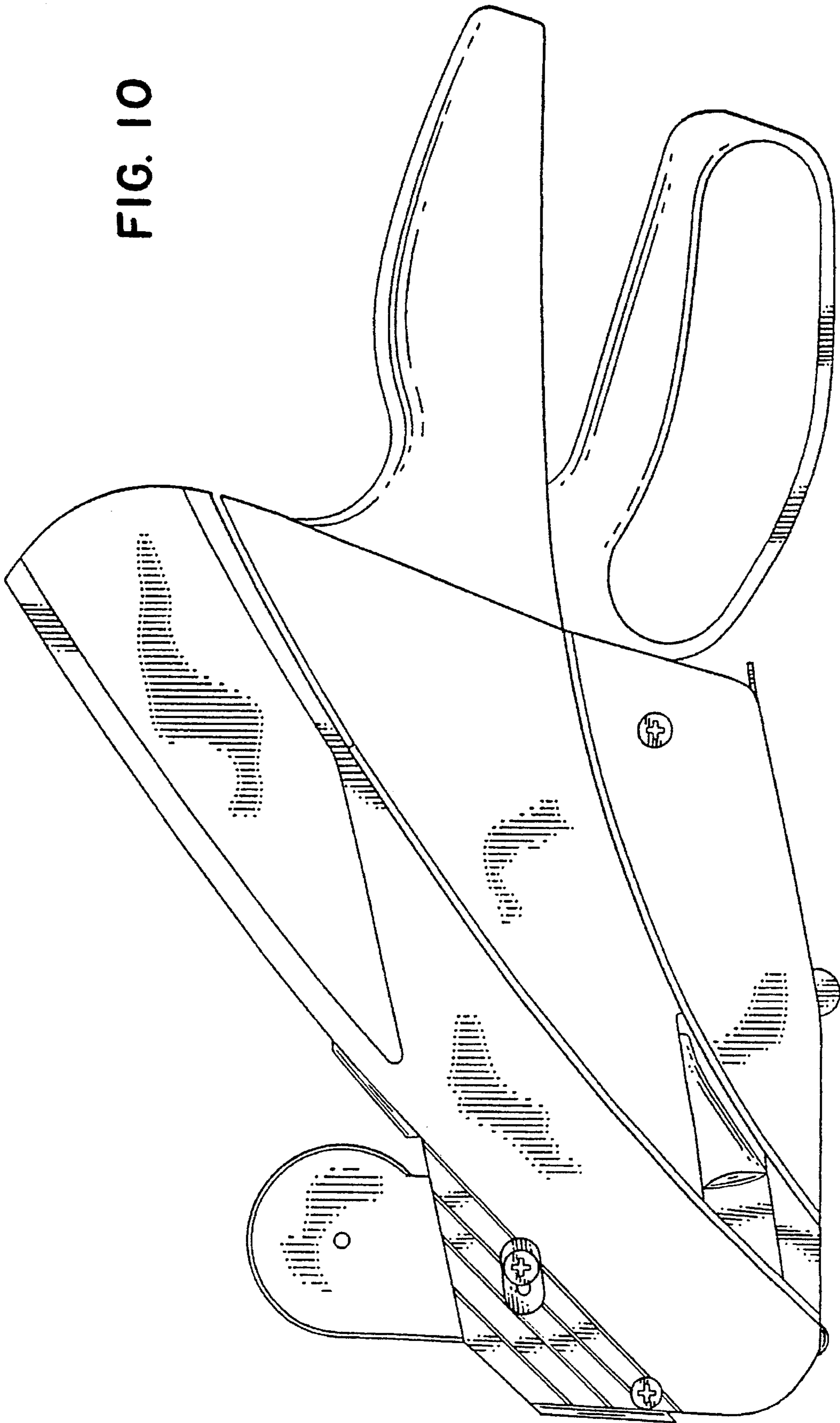

FIG. 10



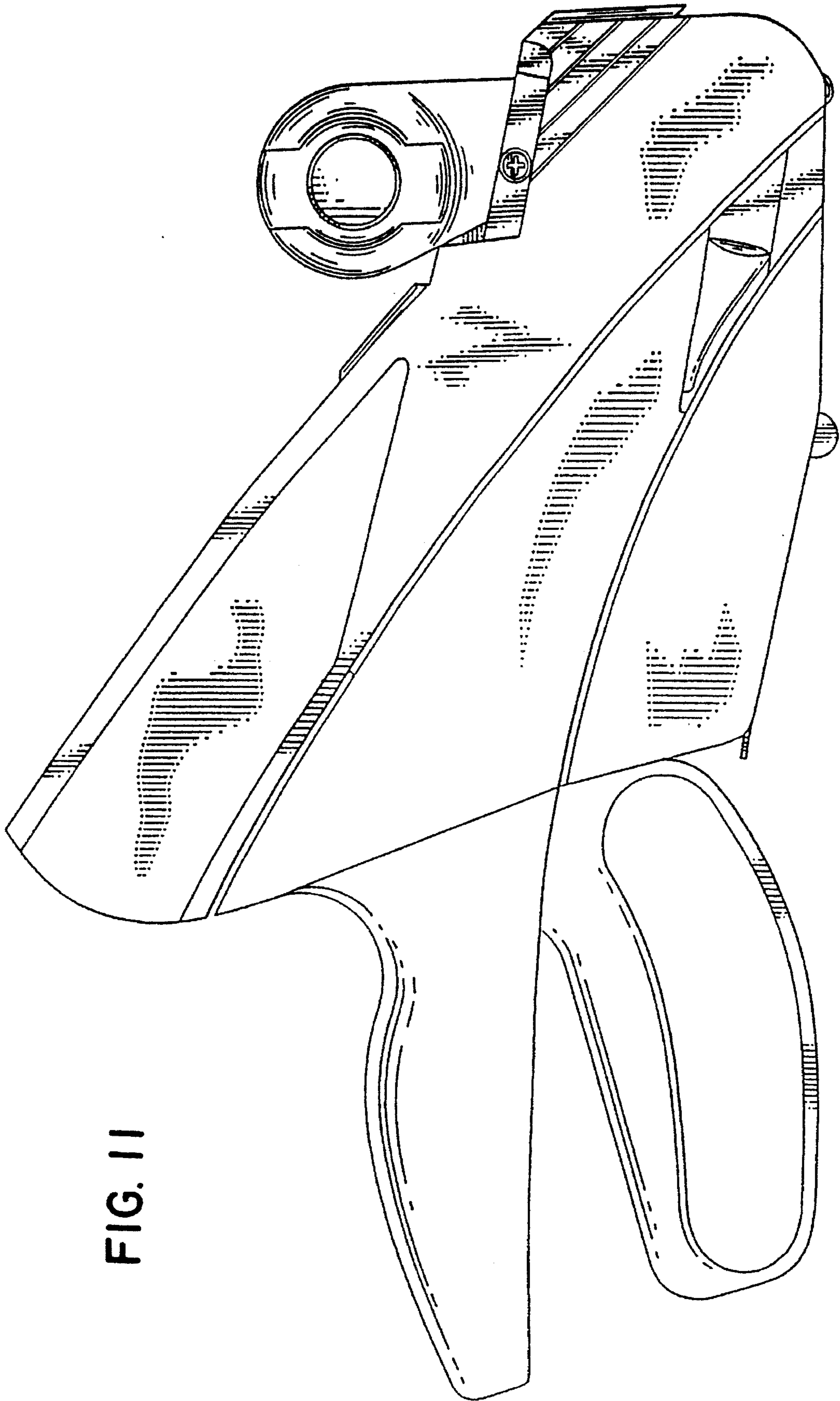

FIG. 11

FIG. 12

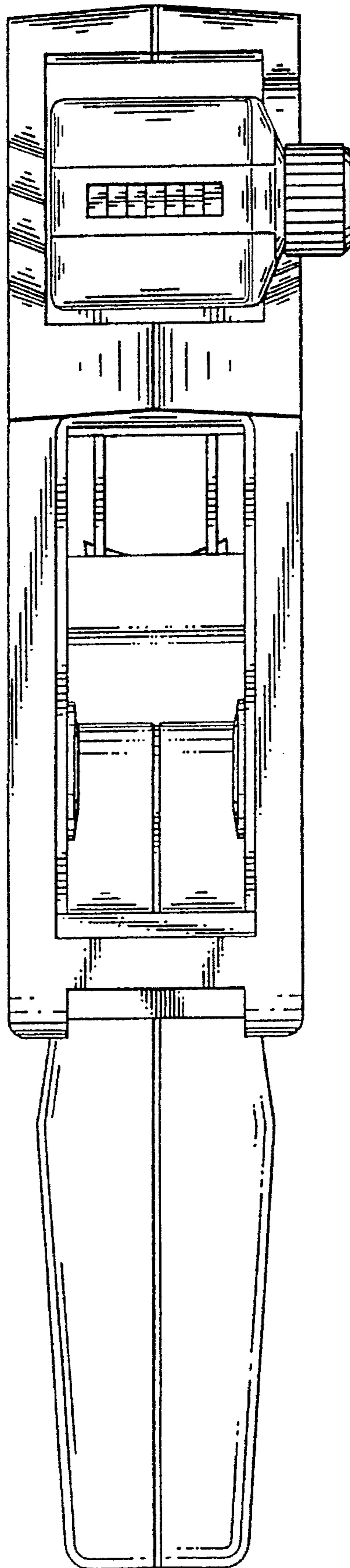

FIG. 13

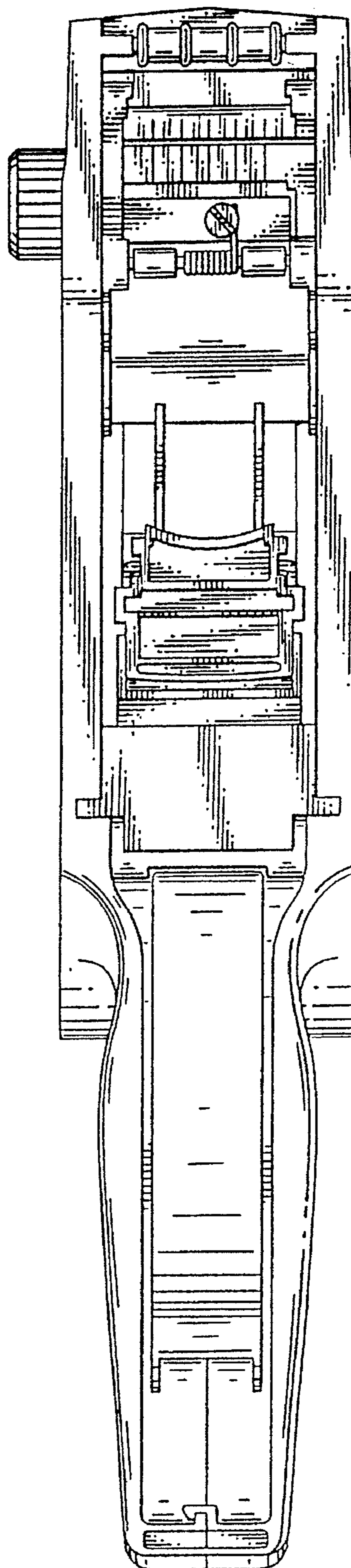

FIG. 14

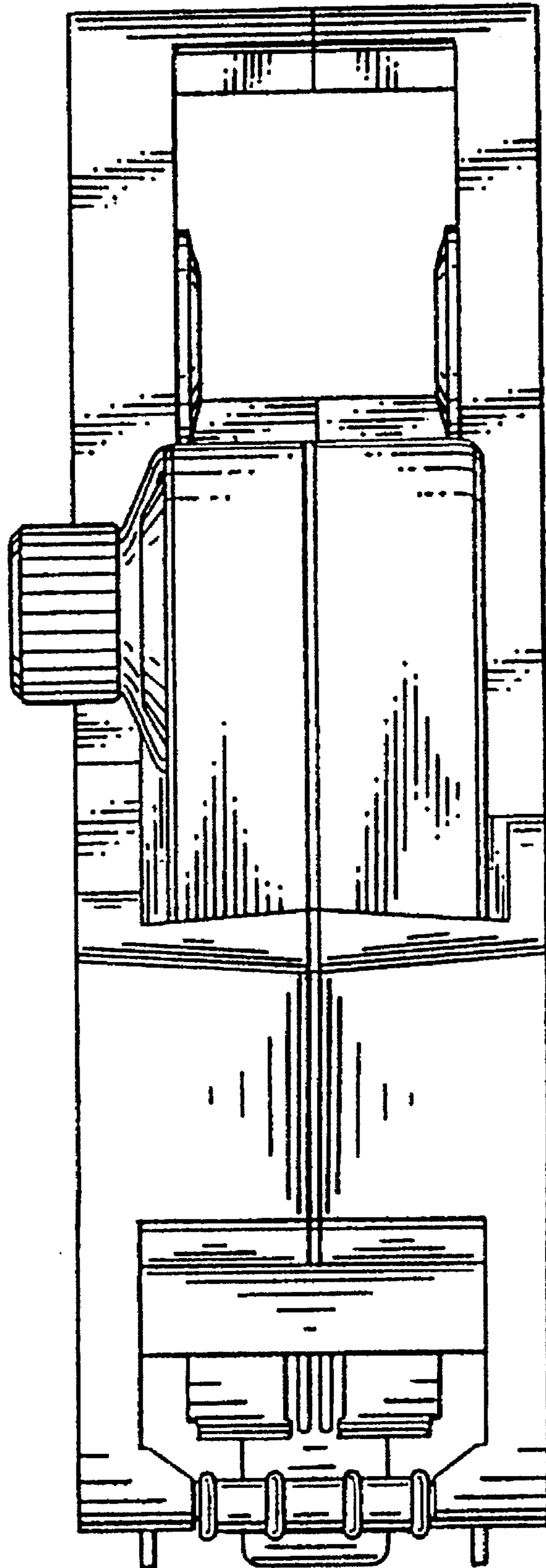
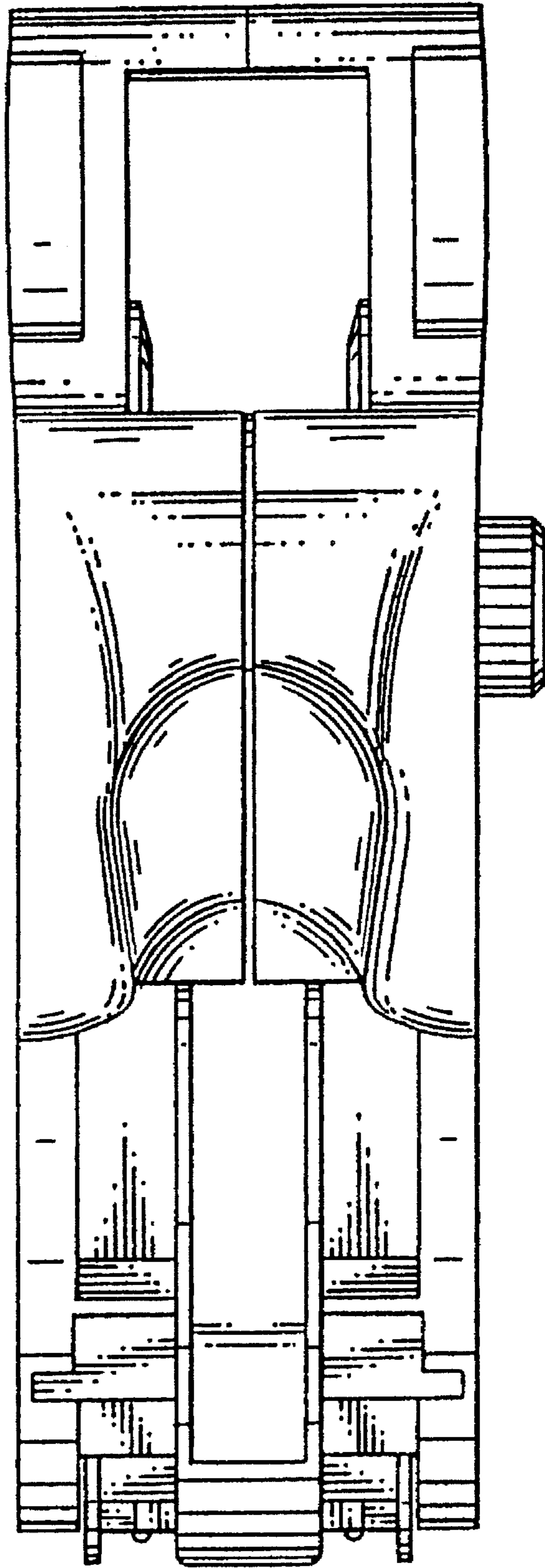

FIG. 15



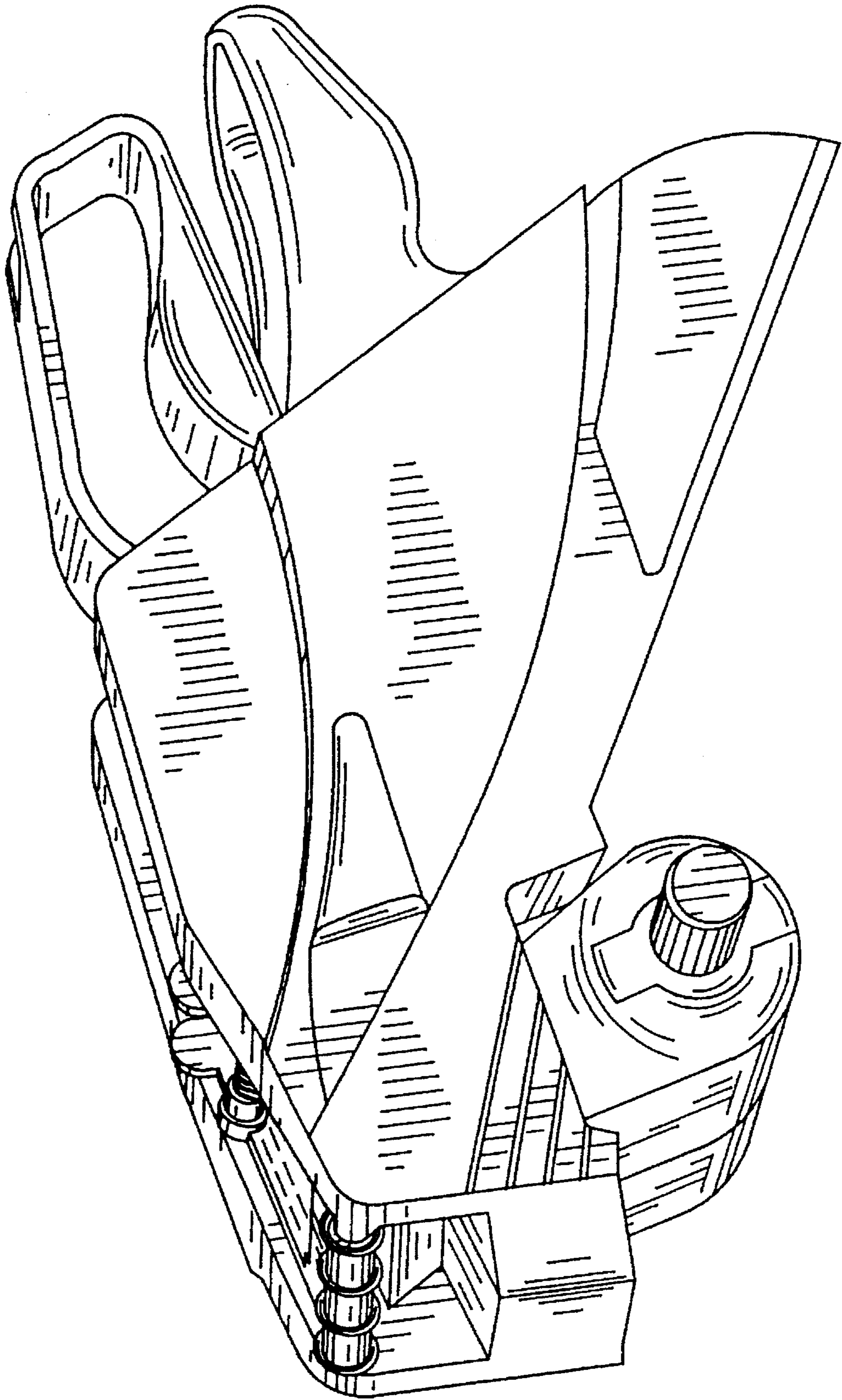

FIG. 16