



US00D365518S

United States Patent [19]
Wysocki

[11] **Patent Number: Des. 365,518**

[45] **Date of Patent: **Dec. 26, 1995**

[54] **OVERCAP FOR A DISPENSER**

[75] Inventor: **J. Christopher Wysocki**, Stow, Ohio

[73] Assignee: **GOJO Industries, Inc.**, Cuyahoga Falls, Ohio

[**] Term: **14 Years**

[21] Appl. No.: **18,961**

[22] Filed: **Feb. 15, 1994**

[52] U.S. Cl. **D9/445**

[58] **Field of Search** D7/396.2, 317,
D7/510-511, 622, 629; D9/434-436, 438,
480, 443, 445-448, 449, 453-454; 215/211,
216, 232, 235, 237, 246, 251, 253; 220/266,
268, 259, 283, 288, 334, 337-338, 344,
359, 375, 711, 713, 715; 222/480, 485,
545

[56] **References Cited**

U.S. PATENT DOCUMENTS

| | | | |
|------------|---------|---------------------|----------|
| D. 241,918 | 10/1976 | Knickerbocker | D9/448 |
| D. 242,227 | 11/1976 | Donoghue | D9/436 |
| D. 274,499 | 7/1984 | Soos | D9/445 |
| D. 282,053 | 1/1986 | Paas | D9/436 |
| D. 287,469 | 12/1986 | Weinberger | D9/435 |
| D. 289,379 | 4/1987 | DeVaughn | D9/453 |
| D. 315,095 | 3/1991 | Wright | D9/443 |
| D. 338,828 | 8/1993 | Segati | D9/447 |
| 4,170,316 | 10/1979 | LaBarbera | D9/434 X |

OTHER PUBLICATIONS

Middle overcap shown in top left photograph, *Packaging Magazine*, May 1993, p. 31.

Clear overcap in Exal Corp. ad, *Spray Technology and Marketing Magazine*, Dec. 1993, p. 19.

Primary Examiner—Alan P. Douglas
Assistant Examiner—Robert M. Spear
Attorney, Agent, or Firm—Reese Taylor

[57] **CLAIM**

The ornamental design for an overcap for a dispenser, as shown and described.

DESCRIPTION

FIG. 1 is a perspective view of an overcap for a dispenser; FIG. 2 is a top plan view thereof; FIG. 3 is a front elevational view thereof; FIG. 4 is a side elevational view taken from the left of FIG. 3, the right side being a mirror image thereof; FIG. 5 is a bottom plan view thereof; and, FIG. 6 is a rear elevational view thereof.

The broken lines shown in FIG. 4 are for illustrative purposes only and form no part of the claimed design.

The broken line showing of a pump spout and bottle is for illustrative purposes only and forms no part of the claimed design.

1 Claim, 2 Drawing Sheets

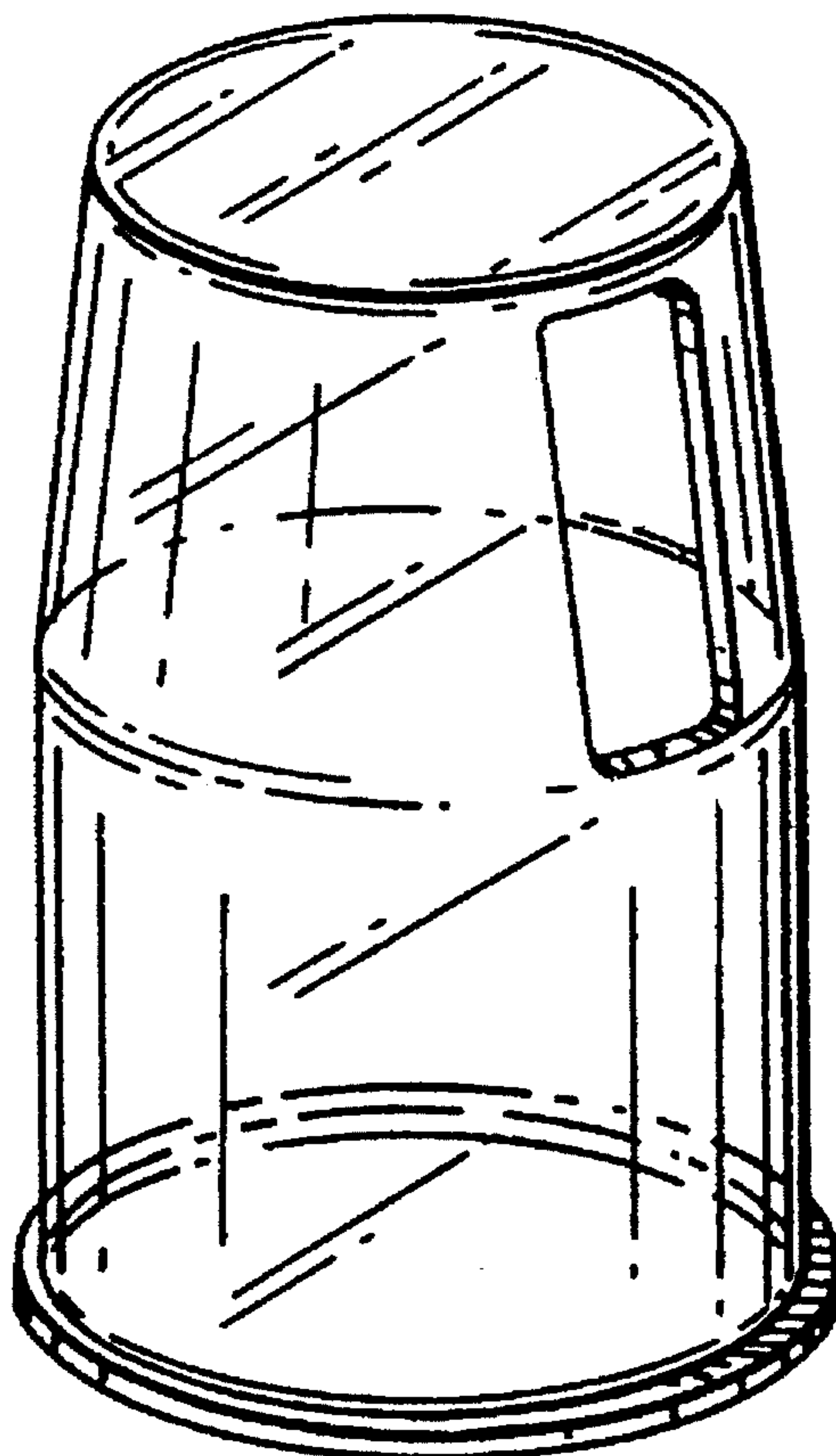

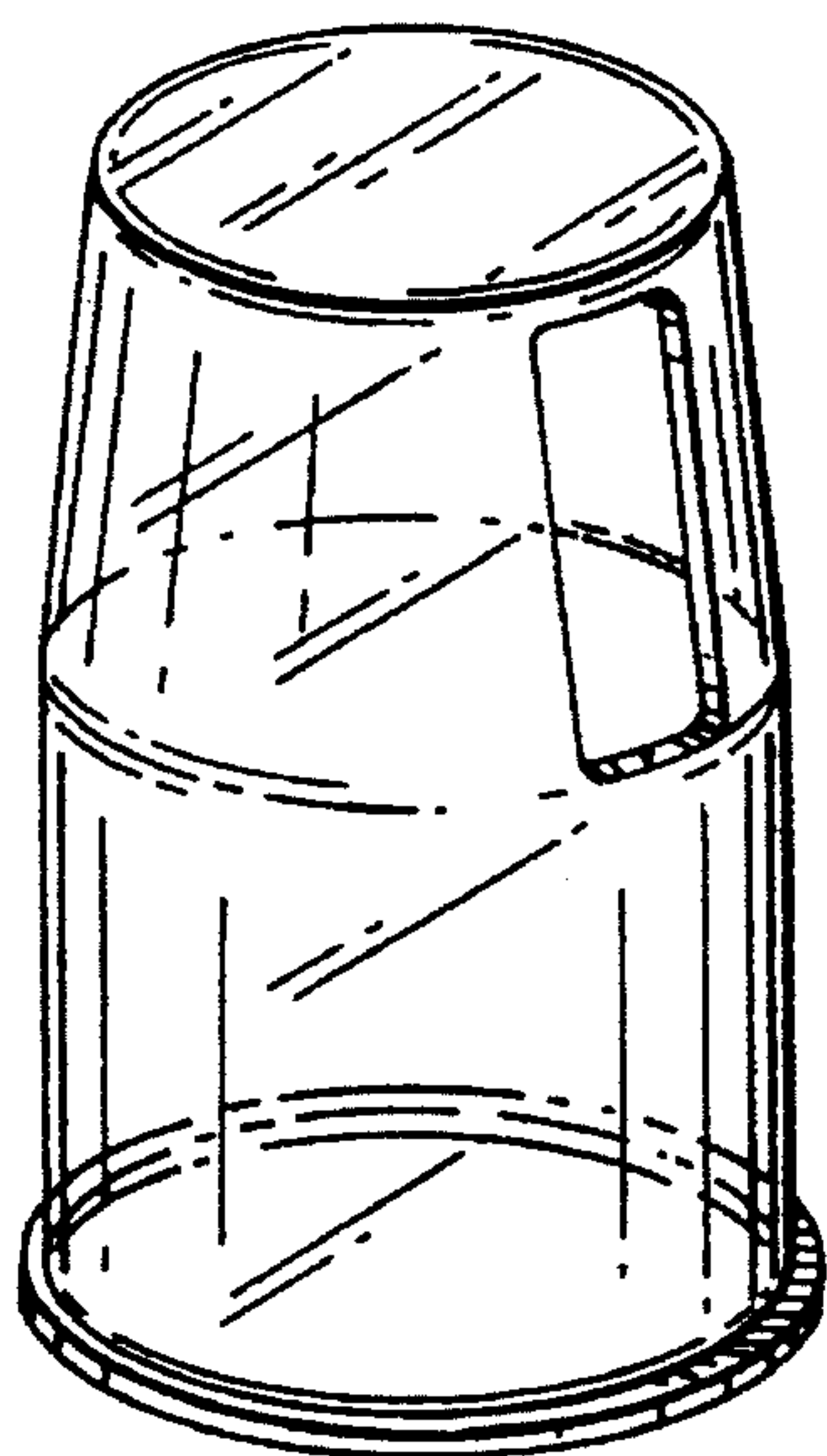

FIG. 1

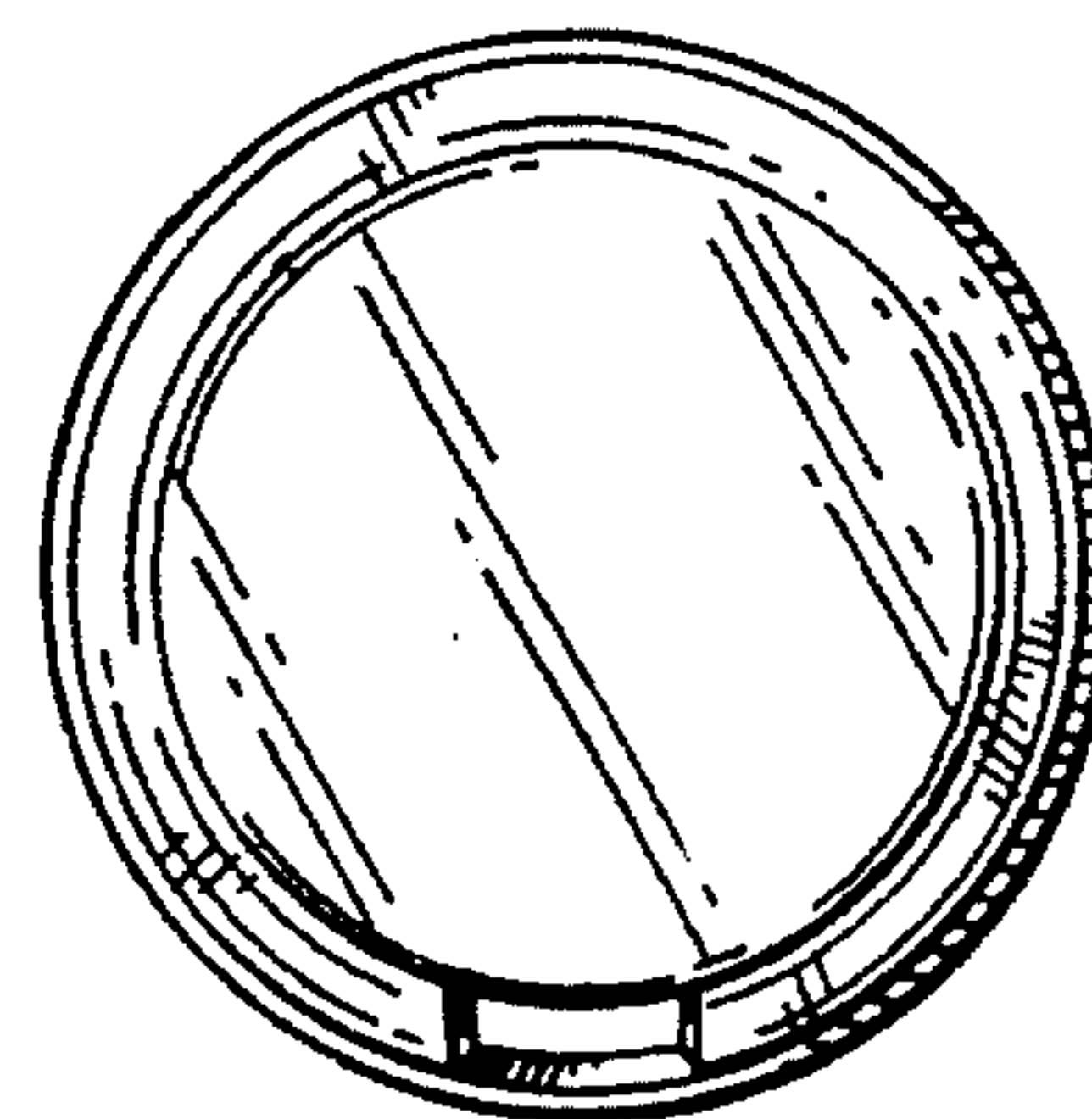

FIG. 2

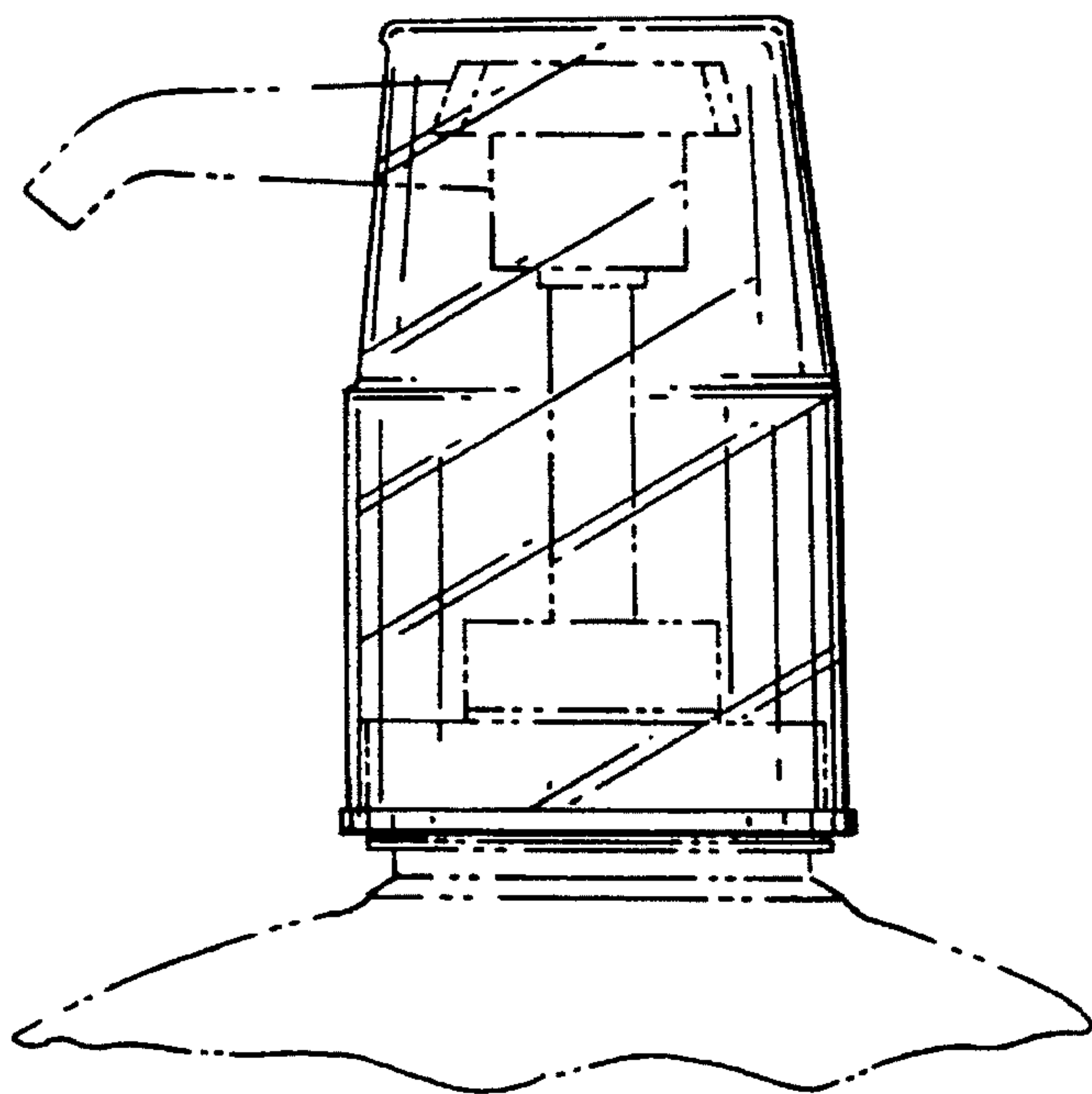

FIG. 4

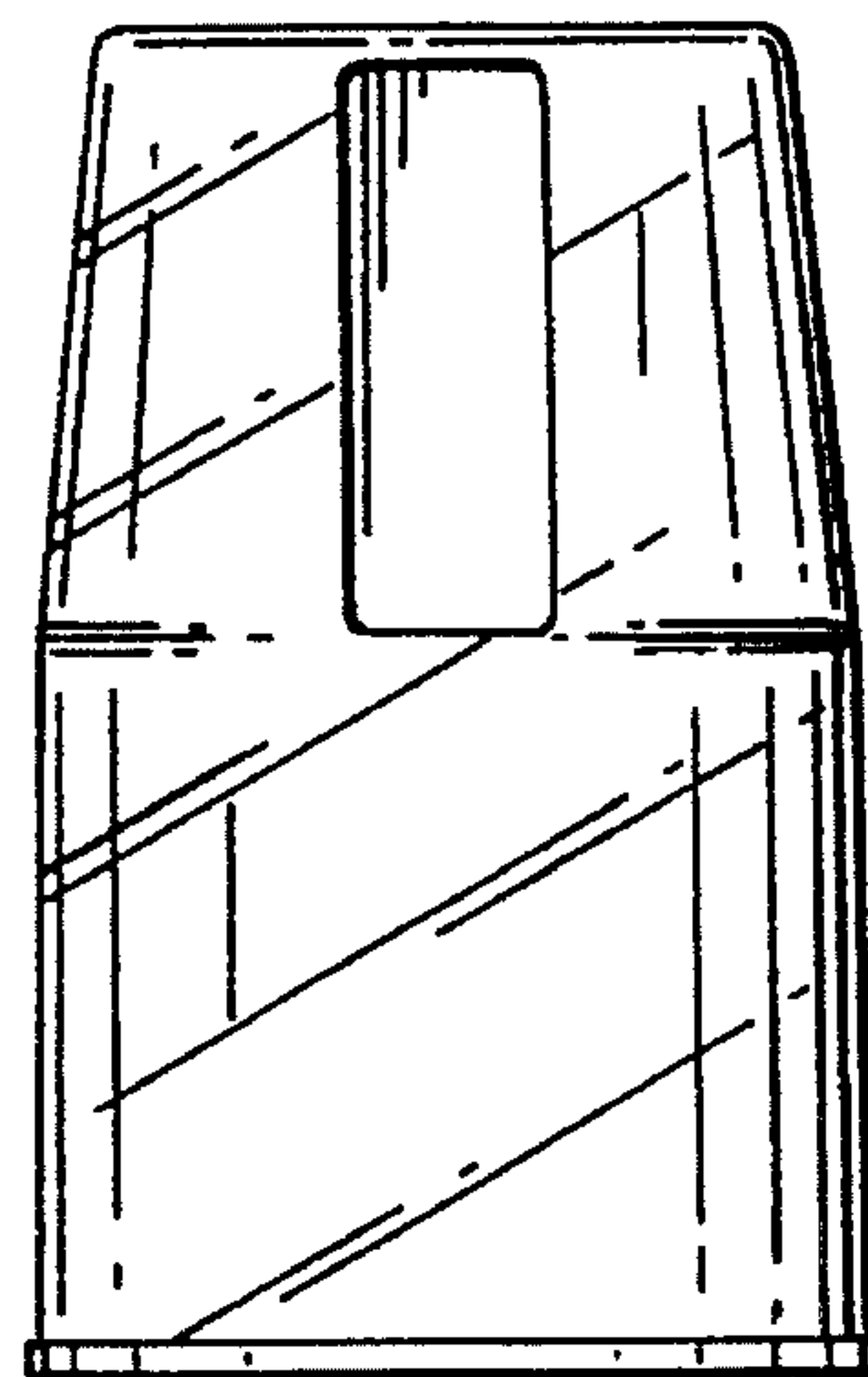

FIG. 3

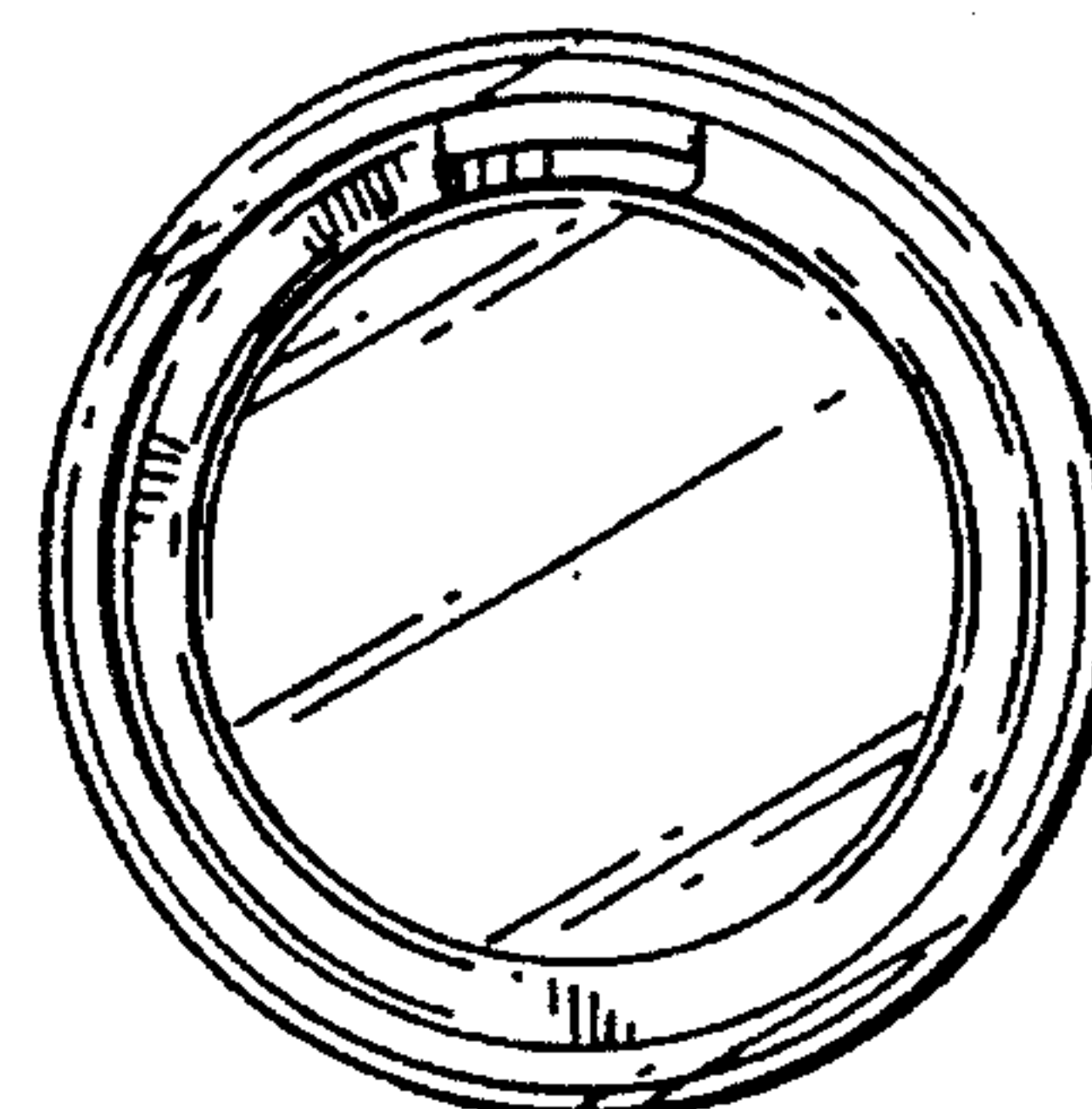

FIG. 5

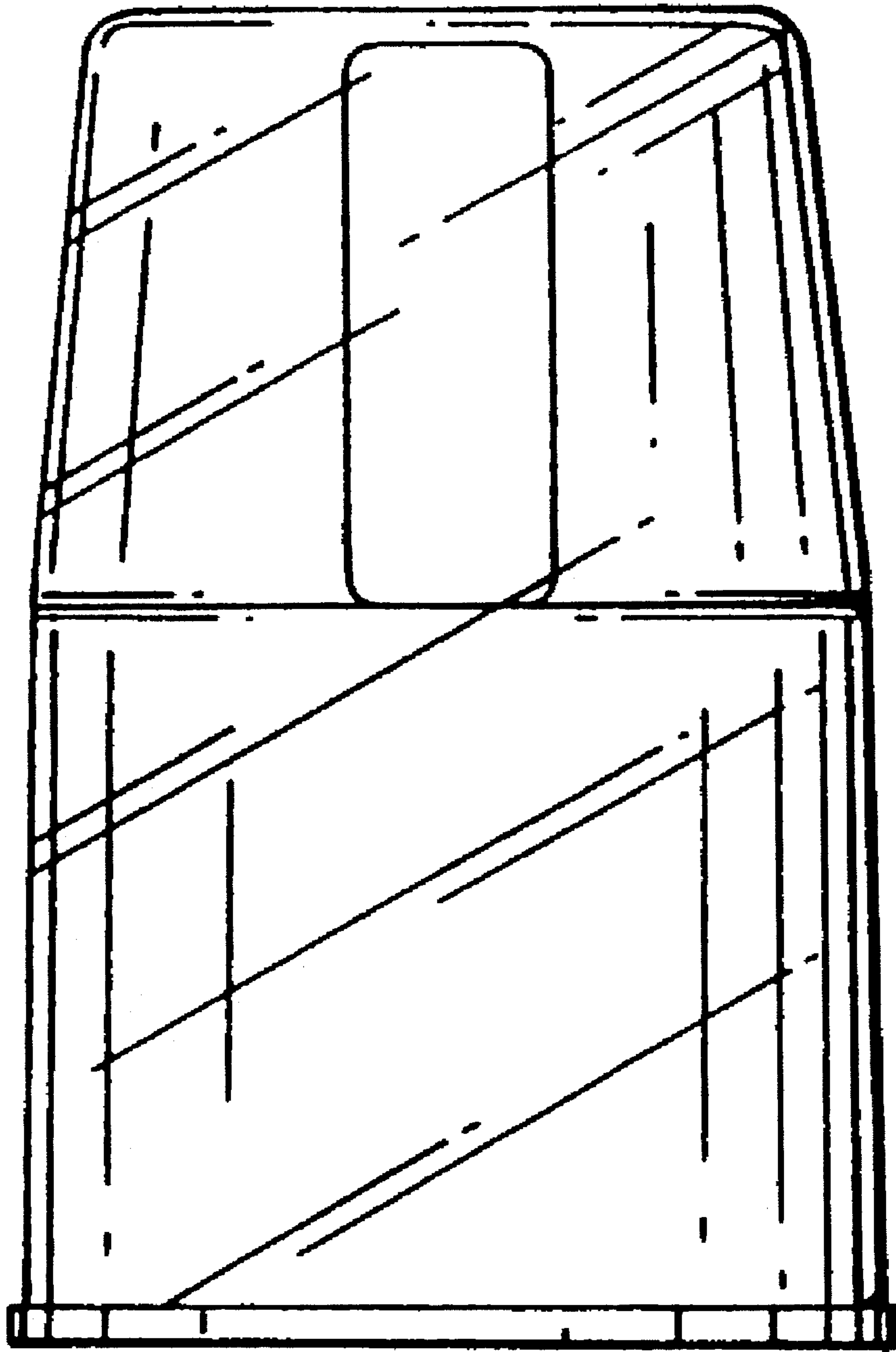

FIG. 6