



US00D365515S

# United States Patent [19]

Boykin

[11] Patent Number: **Des. 365,515**

[45] Date of Patent: **\*\*Dec. 26, 1995**

[54] **COMBINED CONTAINER AND SPRAYER FOR SUN BLOCK**

[76] Inventor: **Marc L. Boykin**, 1440 Violet Ave.,  
Coeur d'Alene, Id. 83814

[\*\*] Term: **14 Years**

[21] Appl. No.: **30,451**

[22] Filed: **Oct. 31, 1994**

[52] U.S. Cl. .... **D9/300**

[58] Field of Search ..... D9/300, 448, 523;  
D23/223-226, 213; 222/383-385, 335,  
380, 207, 145, 135; 239/337, 333

[56] **References Cited**

**U.S. PATENT DOCUMENTS**

D. 89,152	1/1933	Herbsman et al. ....	D23/225
D. 209,873	1/1968	Smith .....	D23/226 X
D. 213,170	1/1969	Muller et al. ....	D9/300
D. 244,531	5/1977	Klingaman .....	D23/225
D. 256,271	8/1980	Tada .....	D23/226
D. 305,451	1/1990	Rosenbaum .....	D9/300 X

D. 333,616	3/1993	Perkins et al. ....	D9/448
D. 345,302	3/1994	Goehring .....	D9/300
4,220,285	9/1980	Gualdi .....	222/383.1 X
5,421,483	6/1995	Parise .....	222/383.1 X

*Primary Examiner*—Ted Shooman  
*Assistant Examiner*—Cheri Cohen  
*Attorney, Agent, or Firm*—J. Michael McClanahan

[57] **CLAIM**

The ornamental design for a combined container and sprayer for sun block, as shown and described.

**DESCRIPTION**

FIG. 1 is a perspective view of a combined container and sprayer for sun block showing my new design; FIG. 2 is a front elevation view thereof; FIG. 3 is a right side elevation view thereof; FIG. 4 is a left side elevation view thereof; FIG. 5 is a rear elevation view thereof; FIG. 6 is a top plan view thereof; and, FIG. 7 is a bottom plan view thereof.

**1 Claim, 2 Drawing Sheets**

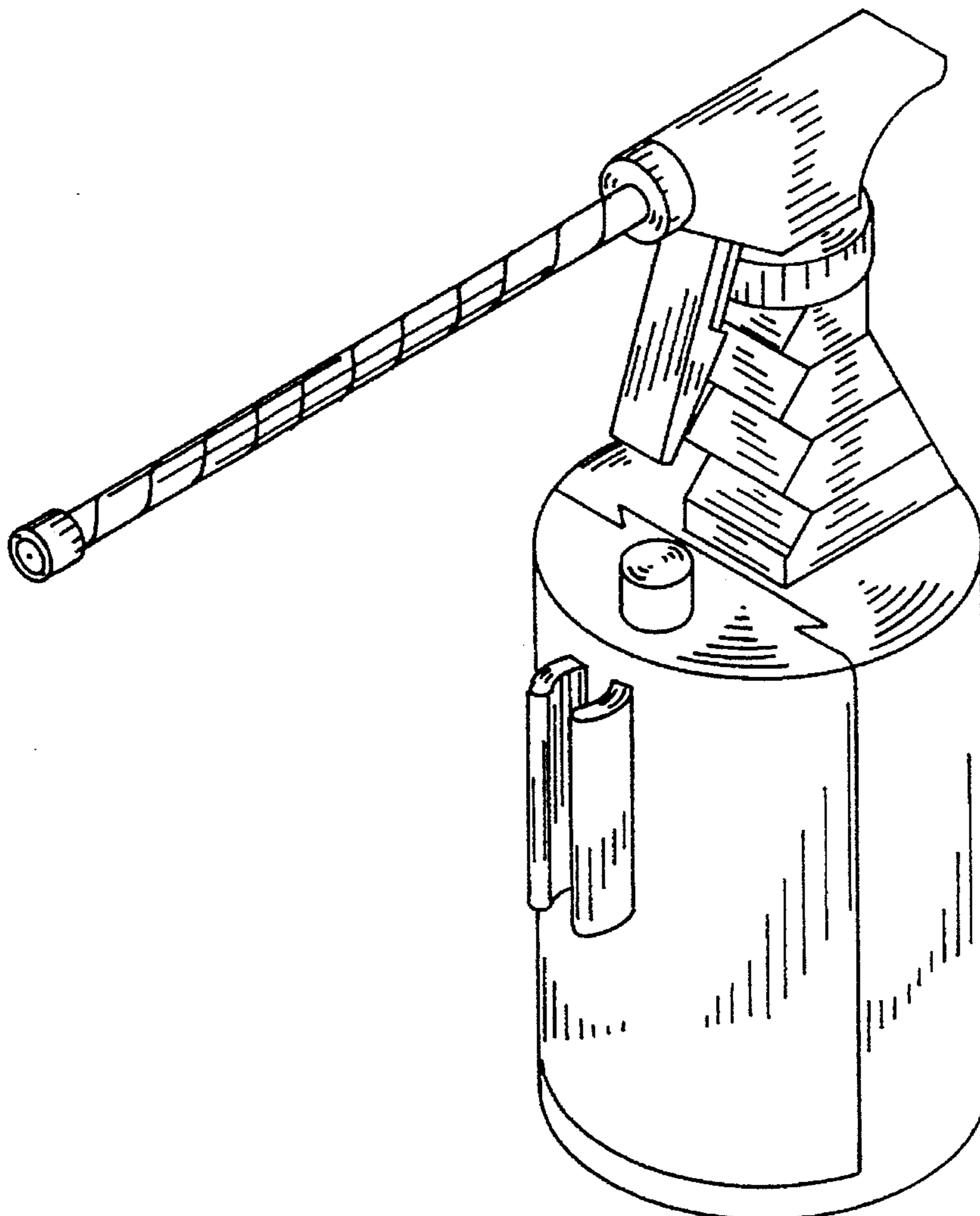

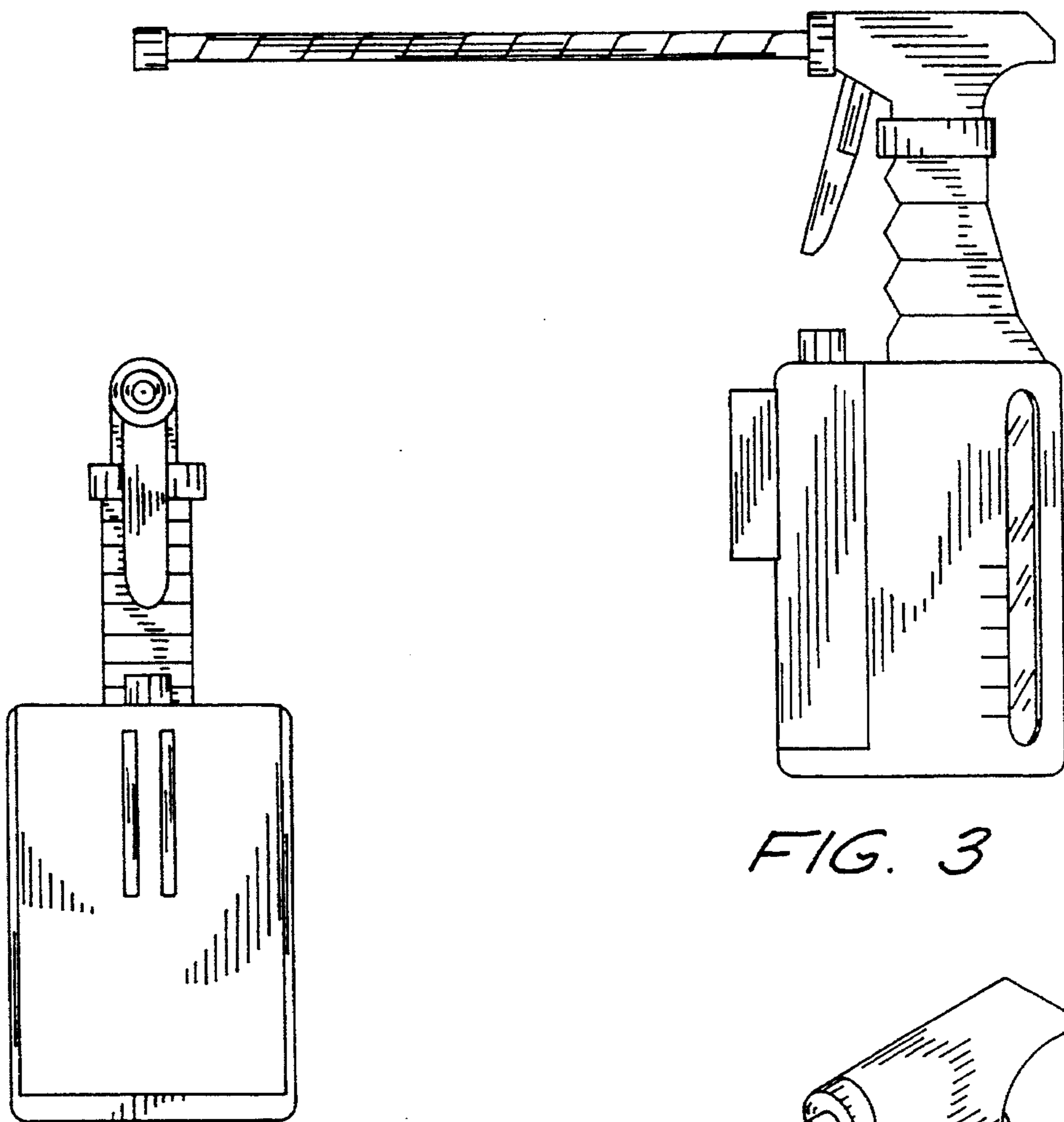

FIG. 2

FIG. 3

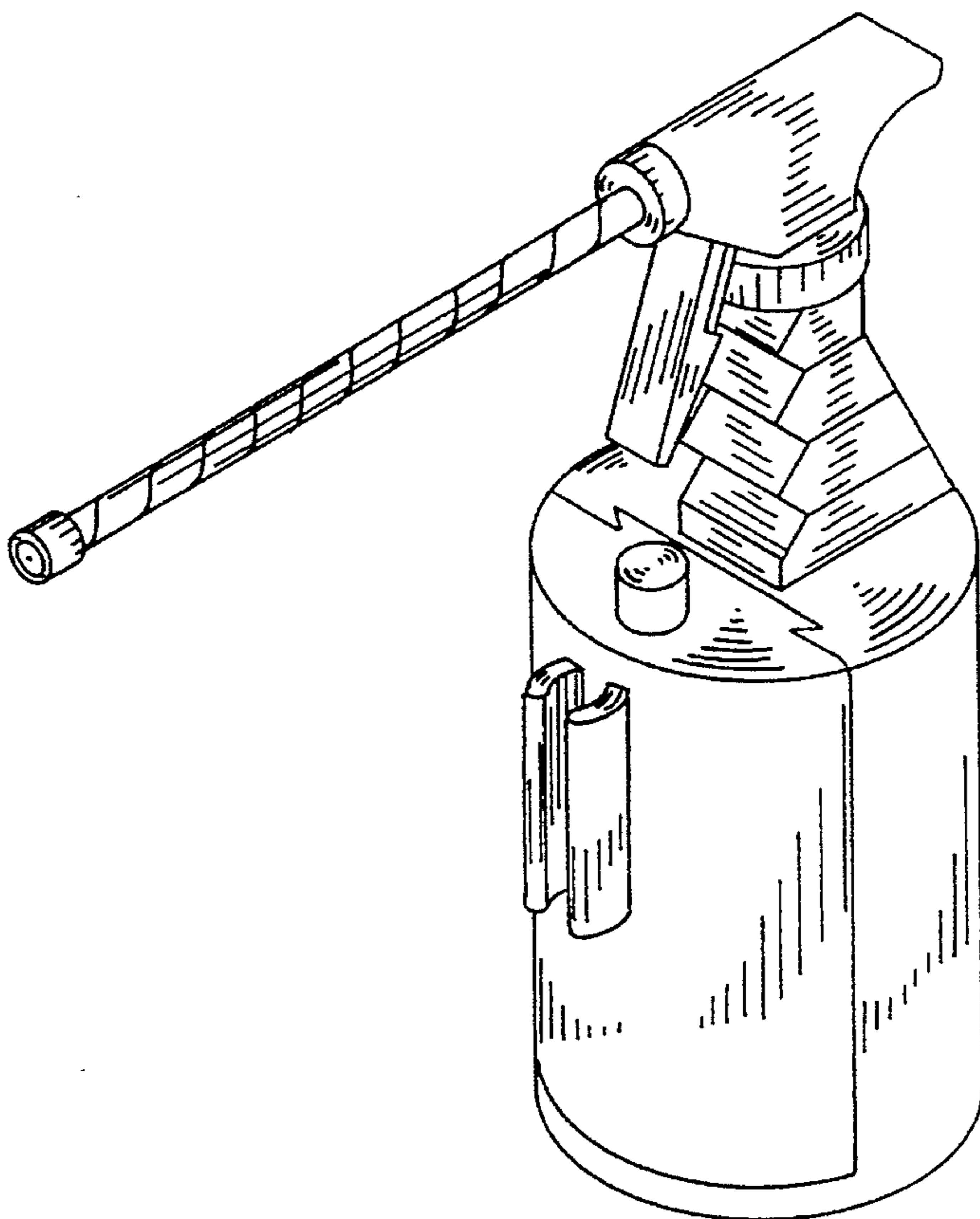

FIG. 1

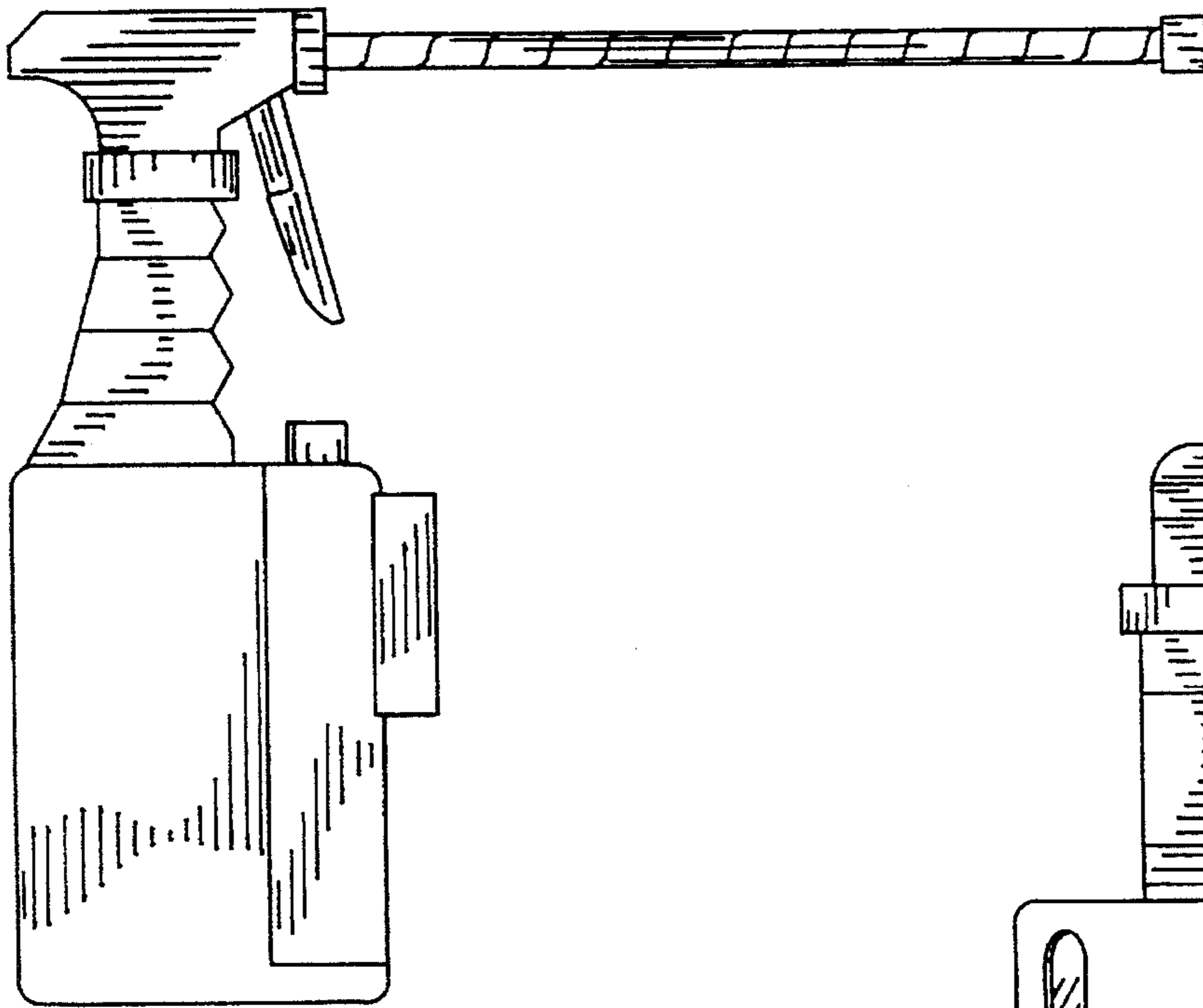

FIG. 4

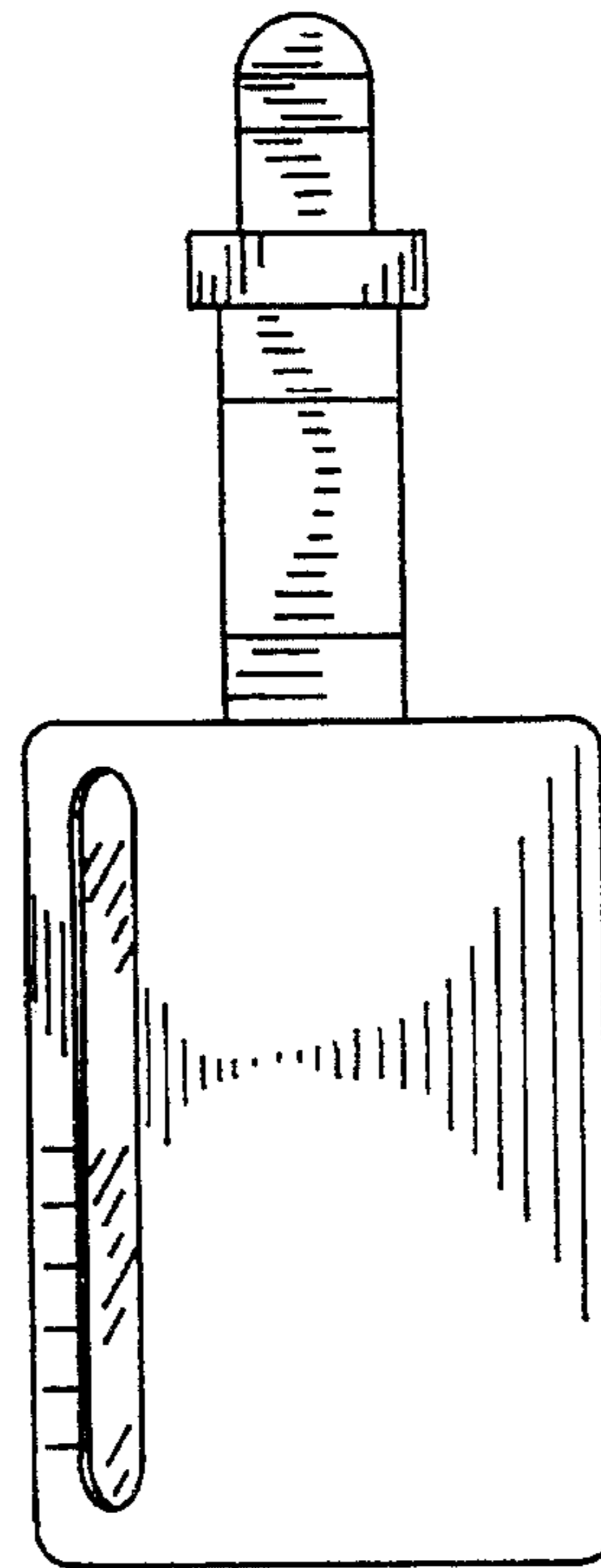

FIG. 5

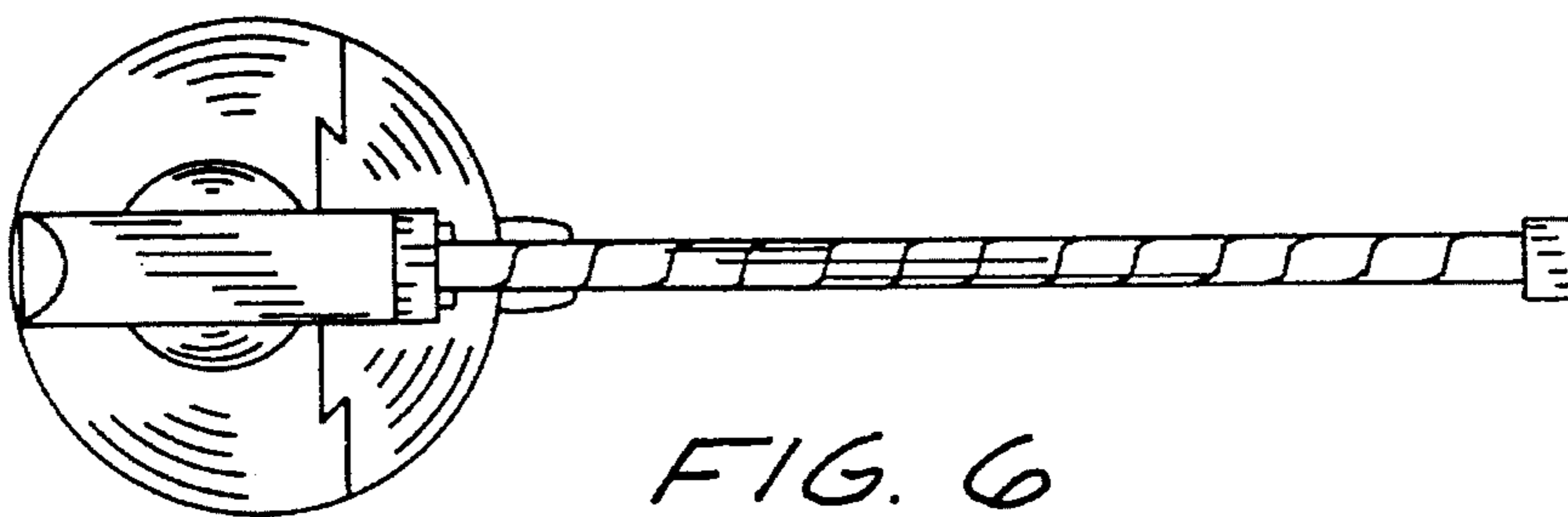

FIG. 6

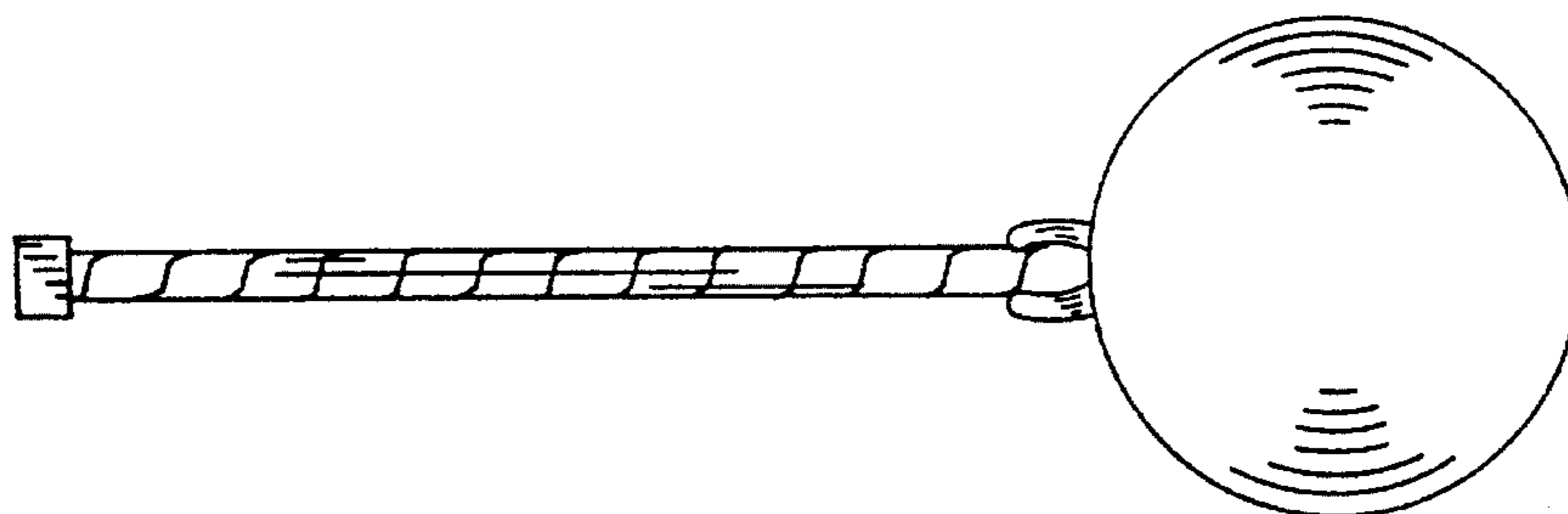

FIG. 7