



US00D365458S

United States Patent [19]

[11] Patent Number: **Des. 365,458**

Natuzzi et al.

[45] Date of Patent: ****Dec. 26, 1995**

[54] SEAT

[75] Inventors: **Pasquale Natuzzi**, Santeramo In Colle;
Arcangelo Scarati, Talsano, both of
Italy

[73] Assignee: **Industrie Natuzzi, SpA**, Bari, Italy

[**] Term: **14 Years**

[21] Appl. No.: **35,907**

[22] Filed: **Mar. 9, 1995**

[52] U.S. Cl. **D6/381**; D6/334

[58] Field of Search D6/334, 335, 336,
D6/364, 371, 373, 381, 500, 501, 502;
297/232, 445, 446

[56] References Cited

U.S. PATENT DOCUMENTS

- D. 343,742 2/1994 Gera D6/381
- D. 353,062 12/1994 Natuzzi et al. D6/381
- D. 358,505 5/1995 Natuzzi et al D6/381

OTHER PUBLICATIONS

Bonmarche, Oct. 30, 1994, p. 2, "Lorenzo" sofa by Natuzzi at top left.

Natuzzi Model 488, Apr. 1989 at International Home Furnishings Market in High Point, North Carolina.

Natuzzi Model 499, Apr. 1989 at International Home Furnishings Market in High Point, North Carolina.

Natuzzi Model 721, Oct. 1989 at International Home Furnishings Market in High Point, North Carolina.

Natuzzi Model 760, Apr. 1990 at International Home Furnishings Market in High Point, North Carolina.

Natuzzi Model 762, Apr. 1990 at International Home Furnishings Market in High Point, North Carolina.

Natuzzi Model 787, Oct. 1990 at International Home Furnishings Market in High Point, North Carolina.

Natuzzi Model 801, Oct. 1990 at International Home Furnishings Market in High Point, North Carolina.

Natuzzi Model 827, Apr. 1991 at International Home Furnishings Market in High Point, North Carolina.

Natuzzi Model 856, Oct. 1991 at International Home Furnishings Market in High Point, North Carolina.

Natuzzi Model 871, Oct. 1991 at International Home Fur-

nishings Market in High Point, North Carolina.

Natuzzi Model 876, Oct. 1991 at International Home Furnishings Market in High Point, North Carolina.

Natuzzi Model 883, Apr. 1991 at International Home Furnishings Market in High Point, North Carolina.

Natuzzi Model 894, Apr. 1992 at International Home Furnishings Market in High Point, North Carolina.

Natuzzi Model 899, Apr. 1992 at International Home Furnishings Market in High Point, North Carolina.

Natuzzi Model 912, Apr. 1992 at International Home Furnishings Market in High Point, North Carolina.

Natuzzi Model 915, Apr. 1992 at International Home Furnishings Market in High Point, North Carolina.

Natuzzi Model 922, Apr. 1992 at International Home Furnishings Market in High Point, North Carolina.

Natuzzi Model 924, Apr. 1992 at International Home Furnishings Market in High Point, North Carolina.

Natuzzi Model 927, Apr. 1992 at International Home Furnishings Market in High Point, North Carolina.

(List continued on next page.)

Primary Examiner—Alan P. Douglas

Assistant Examiner—Gary D. Watson

Attorney, Agent, or Firm—Bell, Seltzer, Park & Gibson

[57] CLAIM

The ornamental design for a seat, as shown and described.

DESCRIPTION

FIG. 1 is a front perspective view of a seat showing our new design in the form of a sofa;

FIG. 2 is a right side elevational view, the left side being a mirror image thereof;

FIG. 3 is a front elevational view;

FIG. 4 is a top plan view;

FIG. 5 is a rear perspective view;

FIG. 6 is a front elevational view of a seat showing our new design in the form of a loveseat; and,

FIG. 7 is a front elevational view of a seat showing our new design in the form of a chair.

The rear view for embodiments 2 and 3 corresponds to FIG. 5, the difference being only a matter of length.

The broken lines shown herein are for illustrative purposes only and form no part of the claimed design.

1 Claim, 3 Drawing Sheets

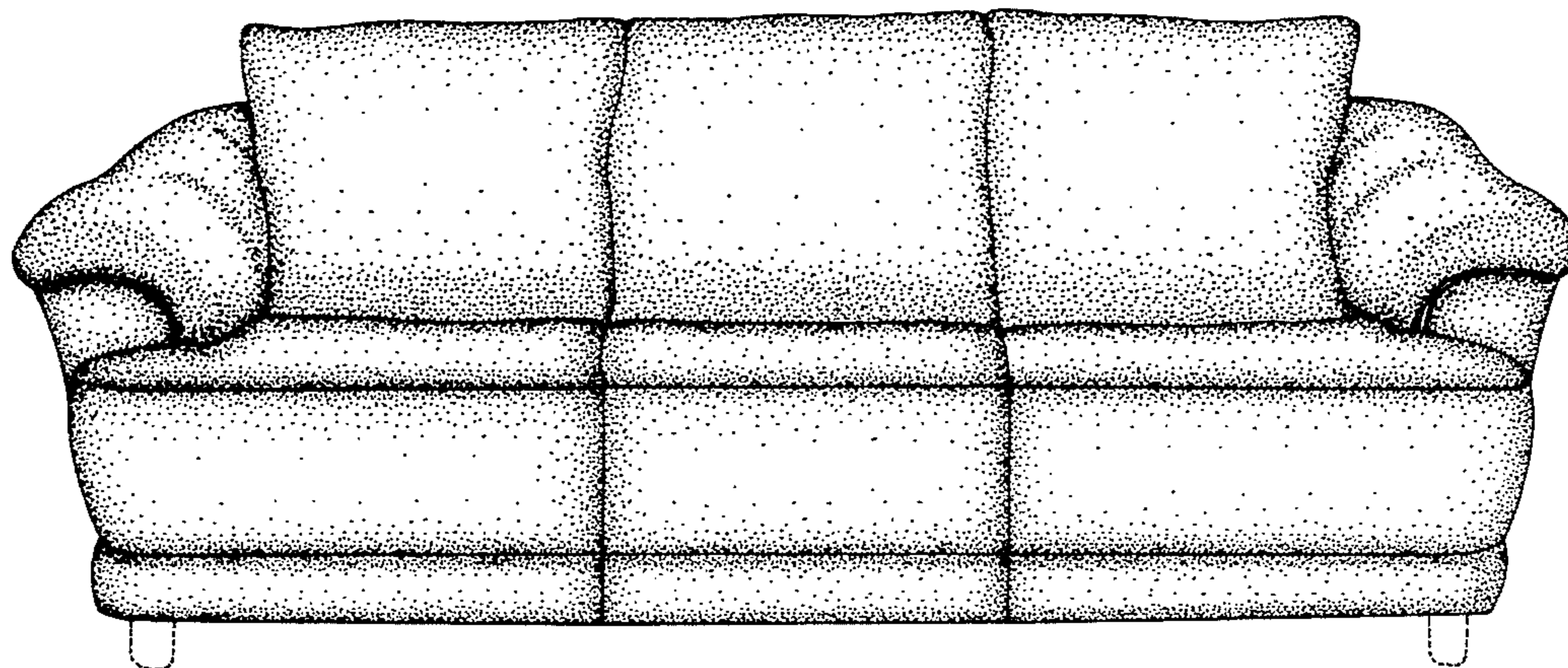

OTHER PUBLICATIONS

Natuzzi Model 942, Oct. 1992 at International Home Furnishings Market in High Point, North Carolina.

Natuzzi Model 954, Oct. 1992 at International Home Furnishings Market in High Point, North Carolina.

Natuzzi Model 972, Oct. 1992 at International Home Furnishings Market in High Point, North Carolina.

Natuzzi Model 1015, Apr. 1993 at International Home Furnishings Market in High Point, North Carolina.

Natuzzi Model 1034, Apr. 1993 at International Home Furnishings Market in High Point, North Carolina.

Natuzzi Model 1035, Apr. 1993 at International Home Furnishings Market in High Point, North Carolina.

Natuzzi Model 1045, Apr. 1993 at International Home Furnishings Market in High Point, North Carolina.

Natuzzi Model 1066, Oct. 1993 at International Home Furnishings Market in High Point, North Carolina.

Natuzzi Model 1090, Oct. 1993 at International Home Furnishings Market in High Point, North Carolina.

Natuzzi Model 1100, Oct. 1993 at International Home Furnishings Market in High Point, North Carolina.

Natuzzi Model 1118, Oct. 1993 at International Home Furnishings Market in High Point, North Carolina.

Natuzzi Model 1127, Jan. 1994 at International Home Furnishings Market in High Point, North Carolina.

Natuzzi Model 1129, Jan. 1994 at International Home Furnishings Market in High Point, North Carolina.

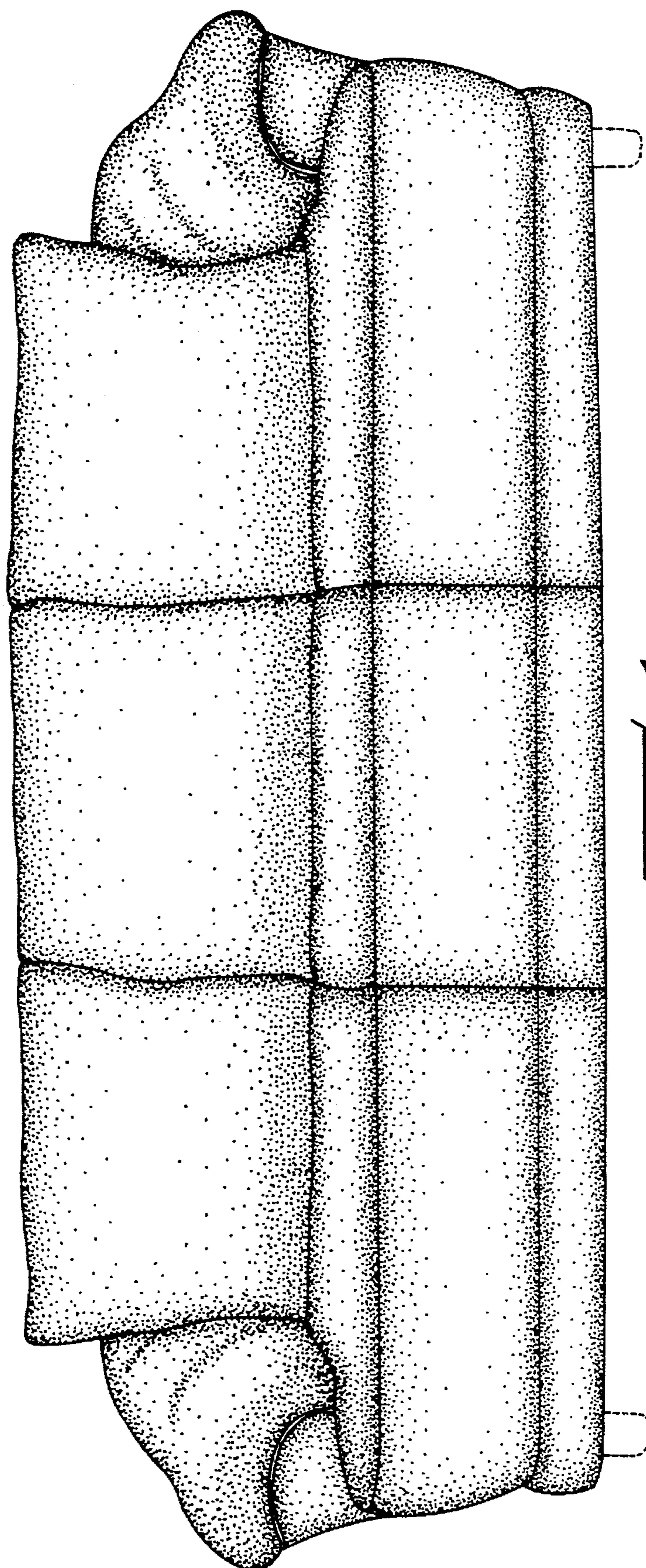

FIG. 1

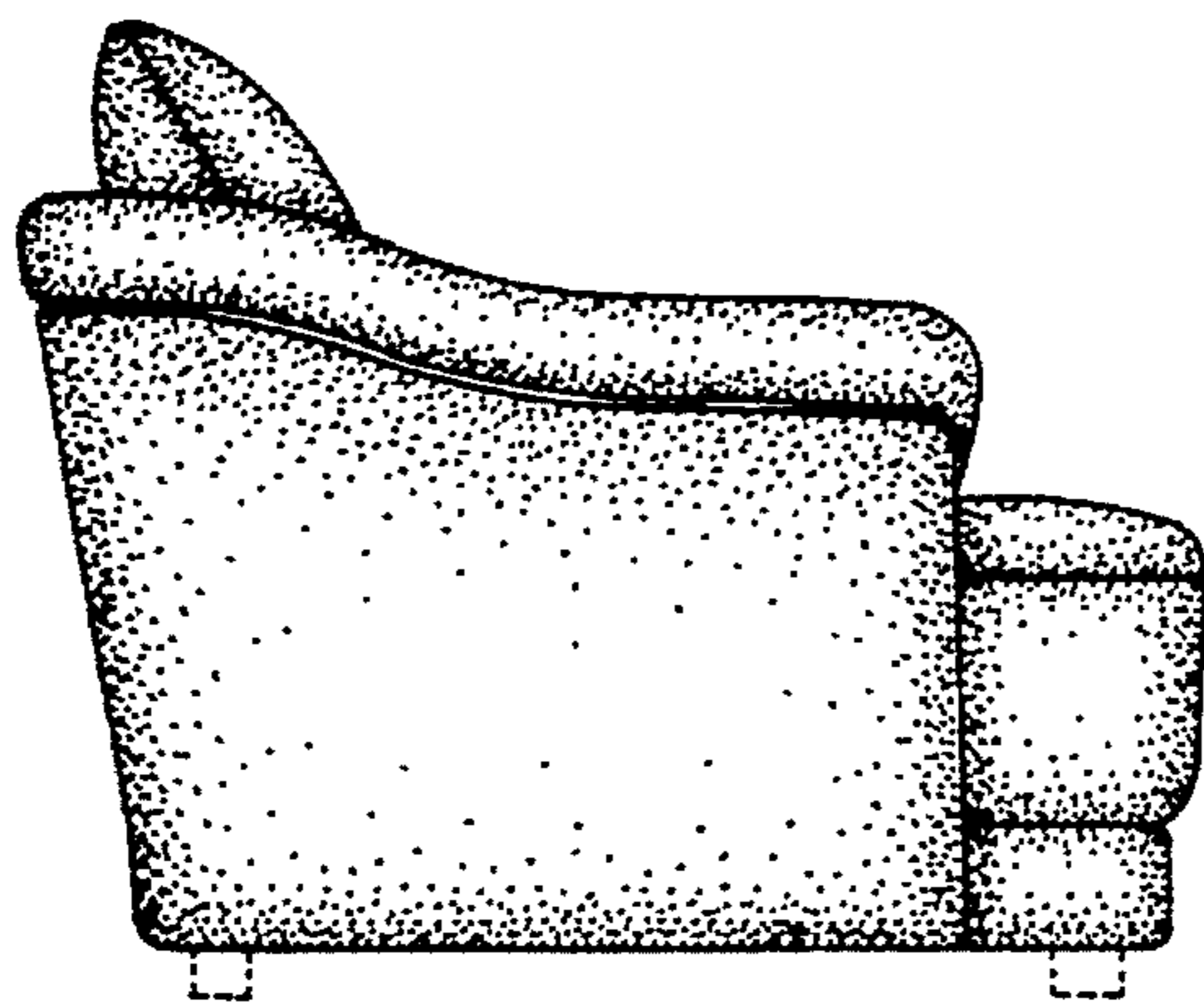

FIG- 2

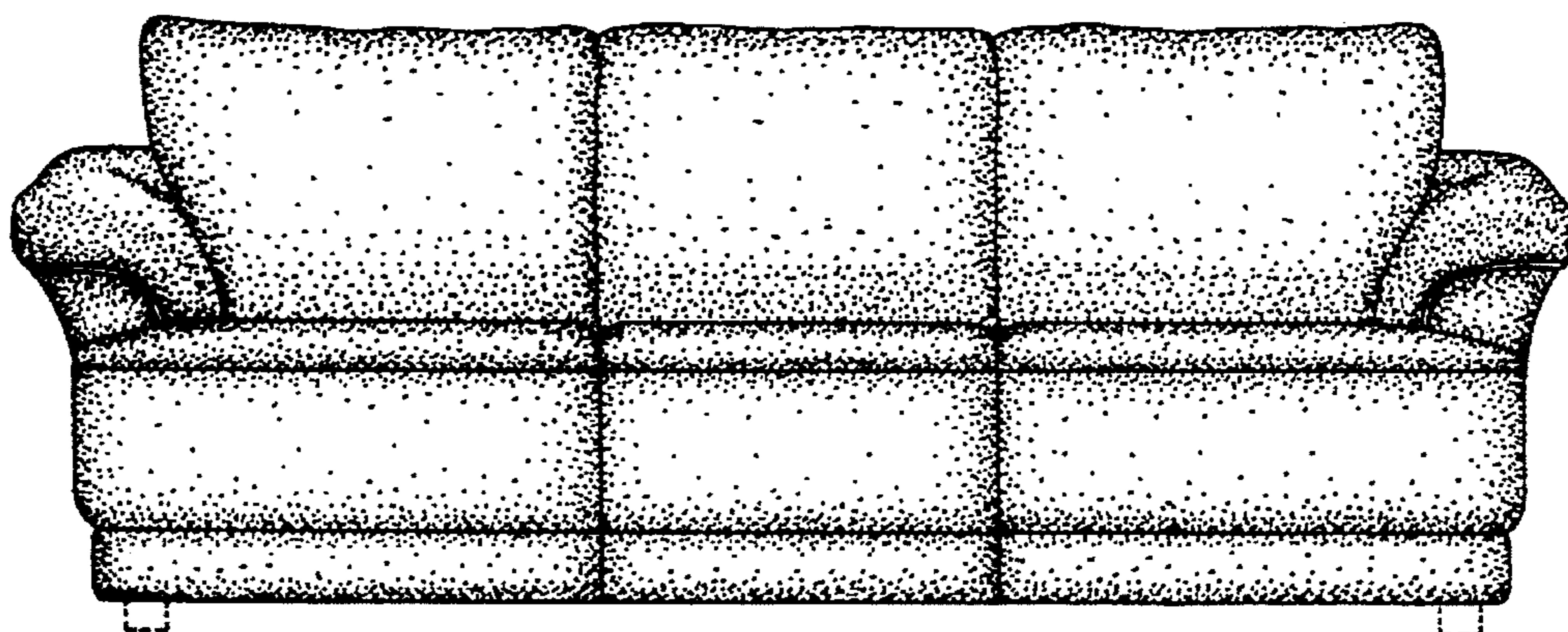

FIG- 3

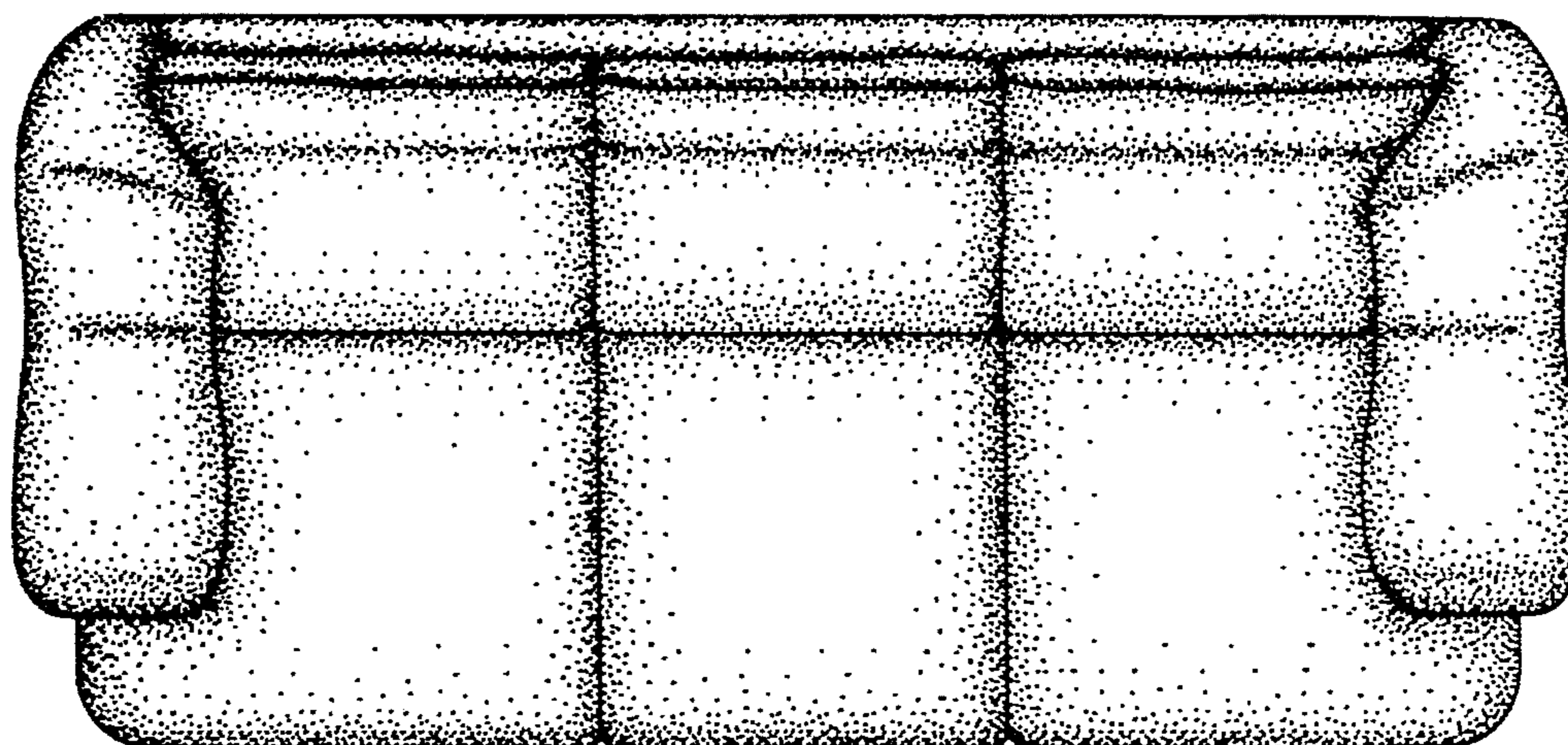

FIG- 4

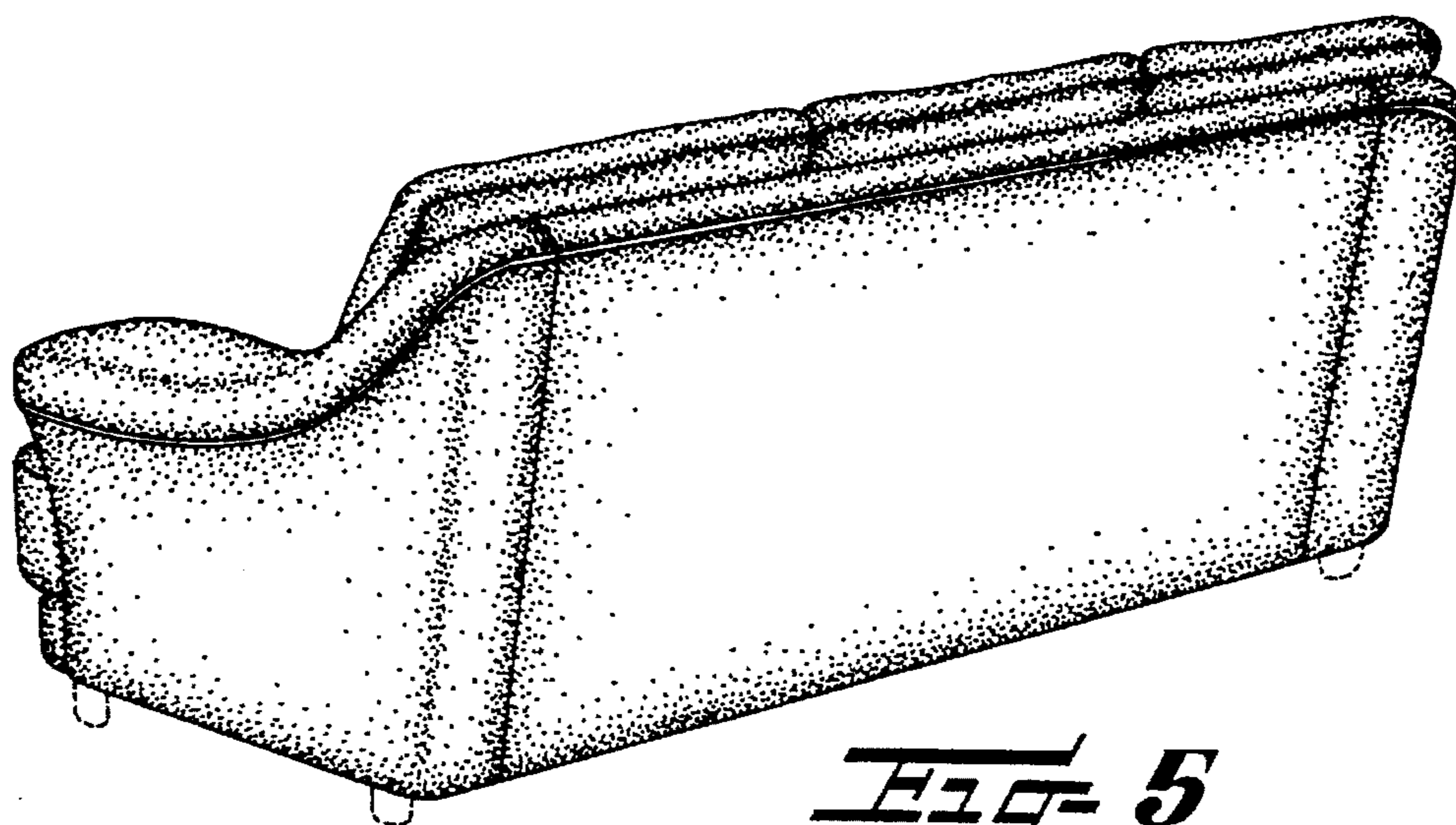

FIG-5

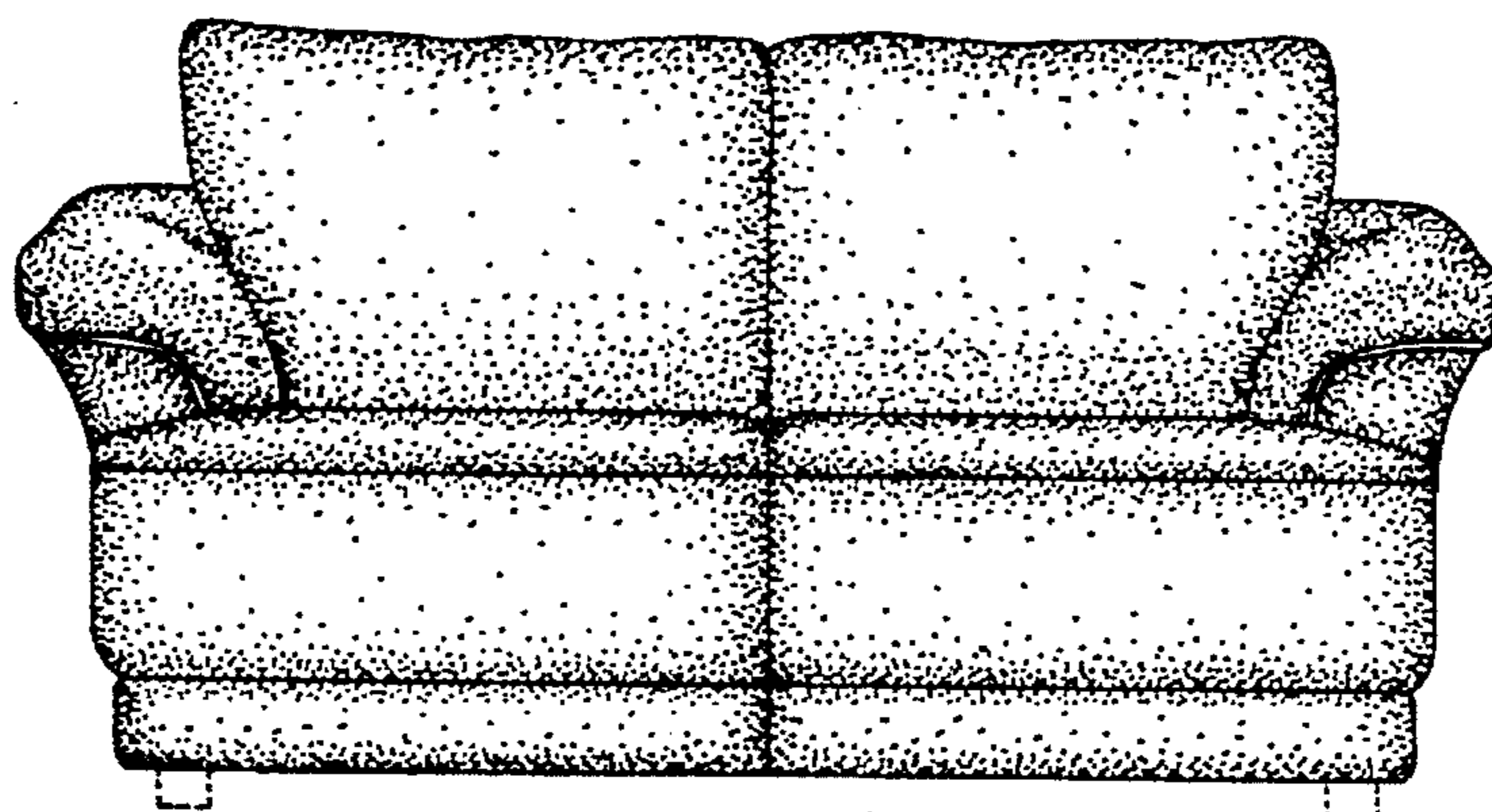

FIG-6

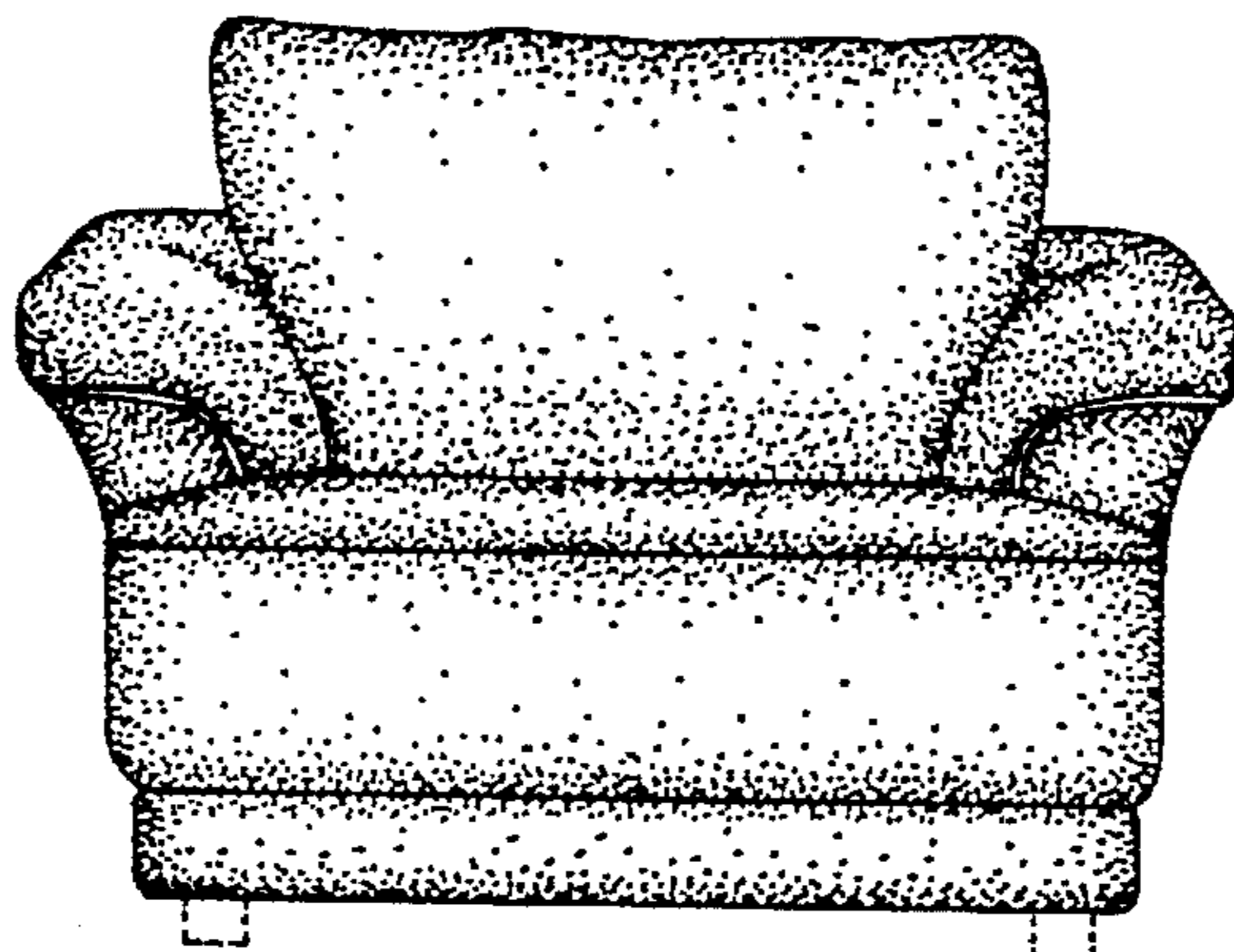

FIG-7