



US00D365336S

United States Patent [19]

[11] Patent Number: Des. 365,336

Vossoughi et al.

[45] Date of Patent: **Dec. 19, 1995

[54] PORTABLE COMPUTER

D. 359,033 6/1995 Lee D14/106

[75] Inventors: **Sohrab Vossoughi**, Portland; **Hiroaki Watanabe**, Beaverton; **Iulius Lucaci**, Portland, all of Oreg.

Primary Examiner—Freda Nunn
Attorney, Agent, or Firm—Curtis G. Rose

[73] Assignee: **Hewlett-Packard Corporation**, Palo Alto, Calif.

[57] CLAIM

The ornamental design for a portable computer, as shown and described.

[**] Term: 14 Years

DESCRIPTION

[21] Appl. No.: 30,705

[22] Filed: Nov. 4, 1994

[52] U.S. Cl. D14/106

[58] Field of Search D14/100, 101, D14/106, 113, 115, 124-127; D18/1, 7, 11; 235/145 A, 145 R; 341/22, 23; 345/104, 156, 168, 173, 901-905, 87; 361/679-686; 364/708.1, 709.04, 709.12; 400/486, 489

FIG. 1 is a perspective view of a portable computer showing my new design, where the top portion of the portable computer is in an open position;
FIG. 2 is a perspective view of the portable computer, where the top portion of the portable computer is in a closed position;
FIG. 3 is a top plan view thereof in the open position;
FIG. 4 is a top plan view thereof in the closed position;
FIG. 5 is a bottom plan view thereof;
FIG. 6 is a front elevational view thereof;
FIG. 7 is a back elevational view thereof;
FIG. 8 is a right side elevational view thereof; and,
FIG. 9 is a left side elevational view thereof.

[56] References Cited

U.S. PATENT DOCUMENTS

D. 350,121 8/1994 Kaneko D14/106
D. 356,069 3/1995 Lee D14/106

1 Claim, 6 Drawing Sheets

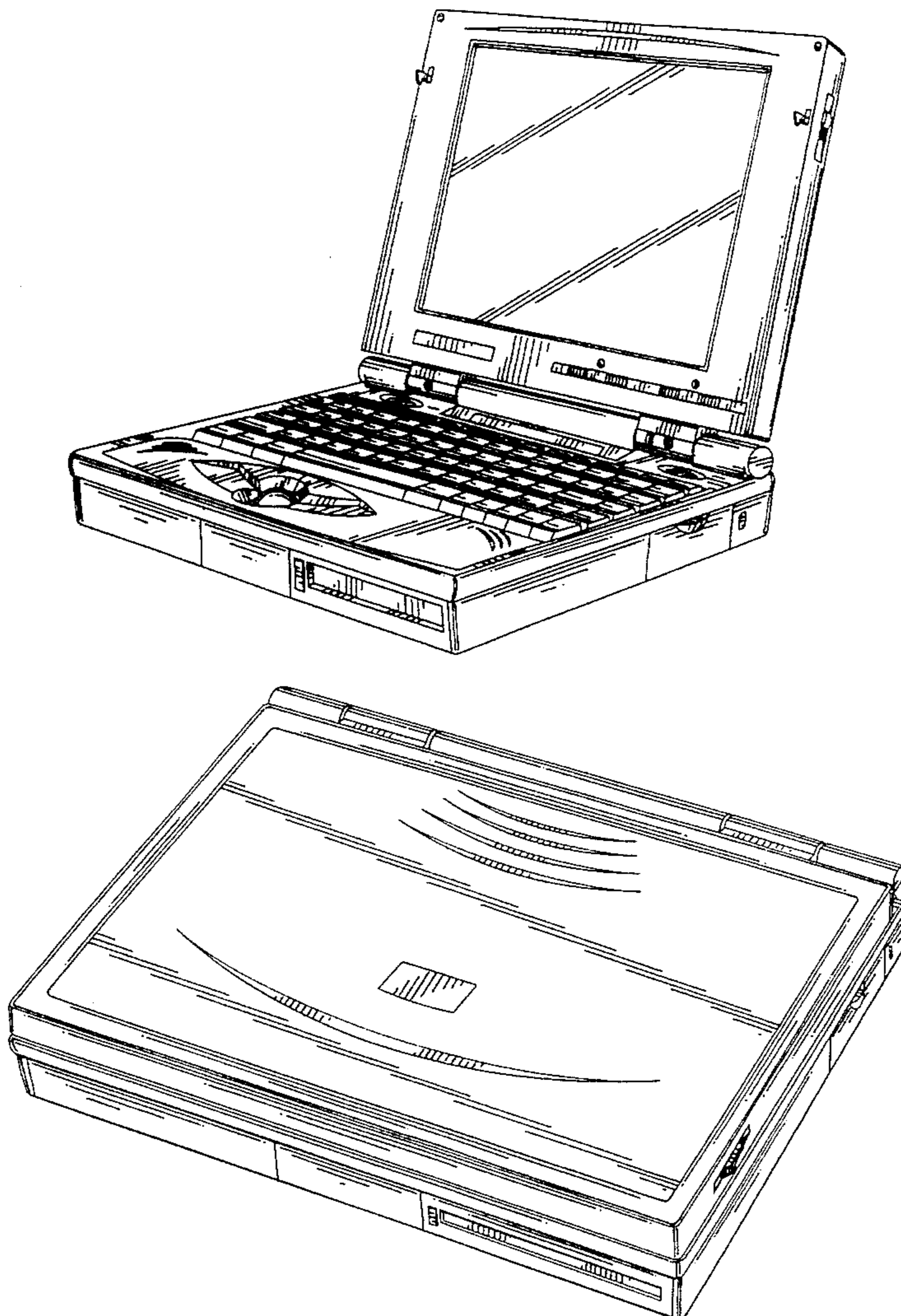

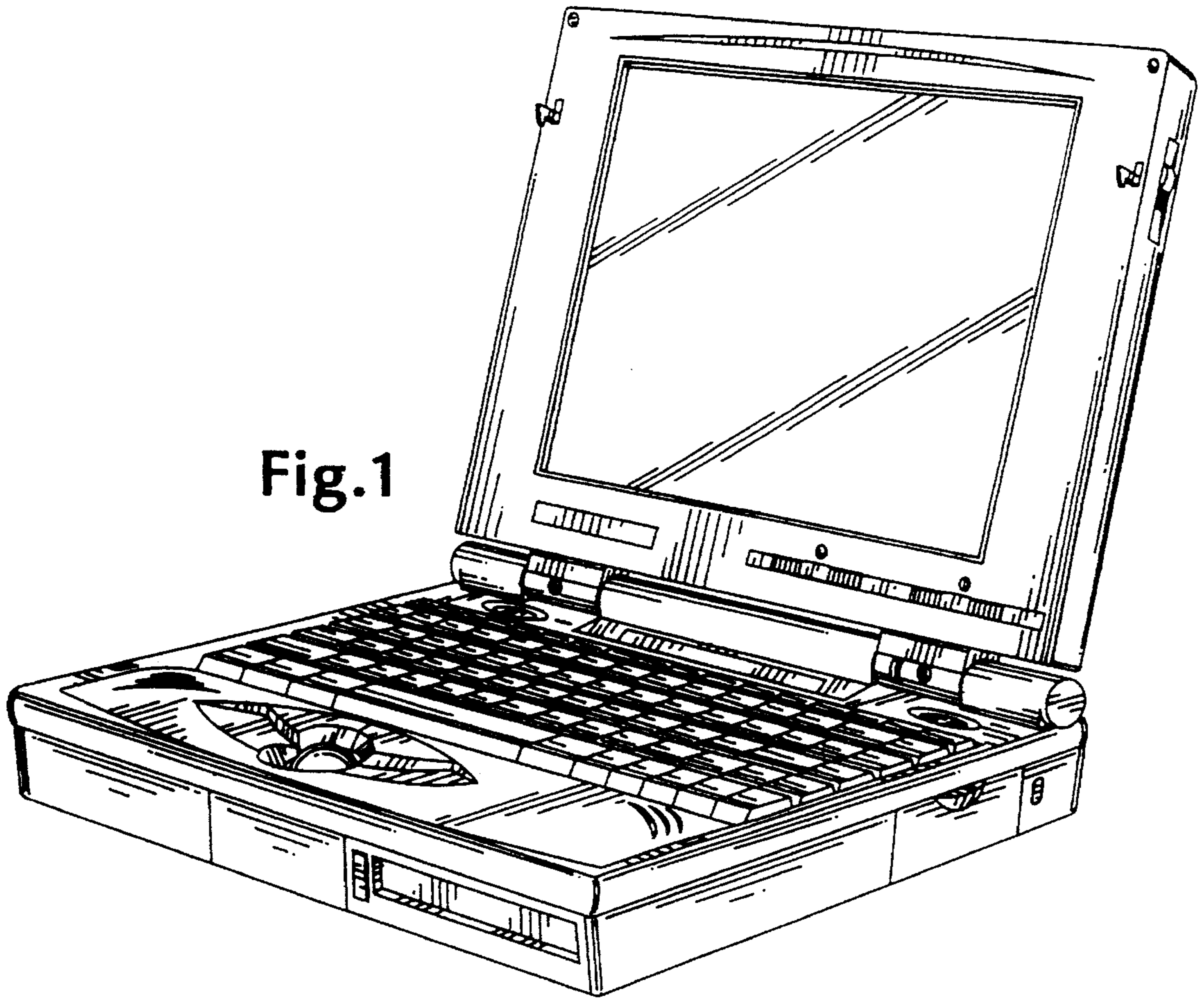

Fig. 1

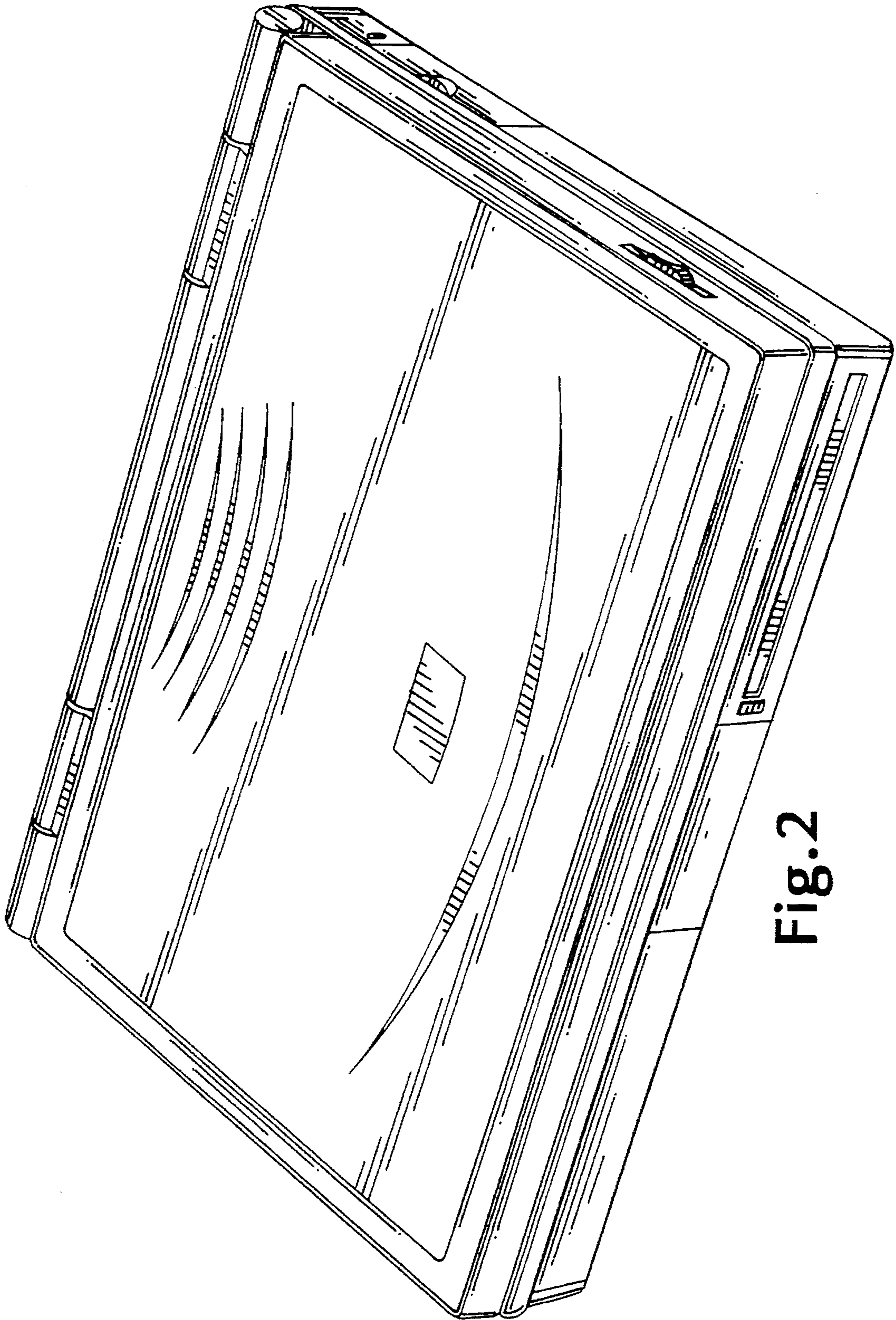

Fig. 2

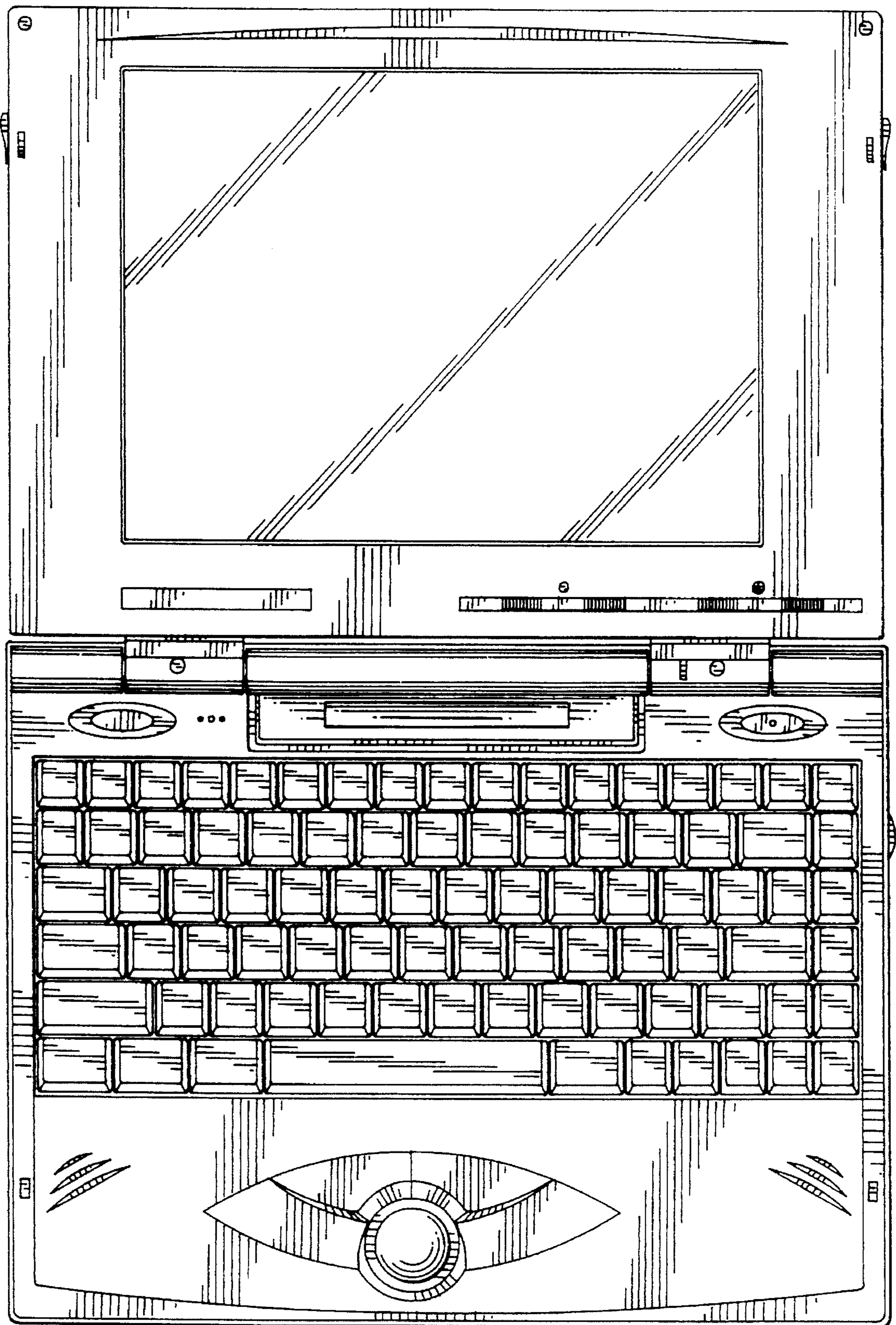

Fig.3

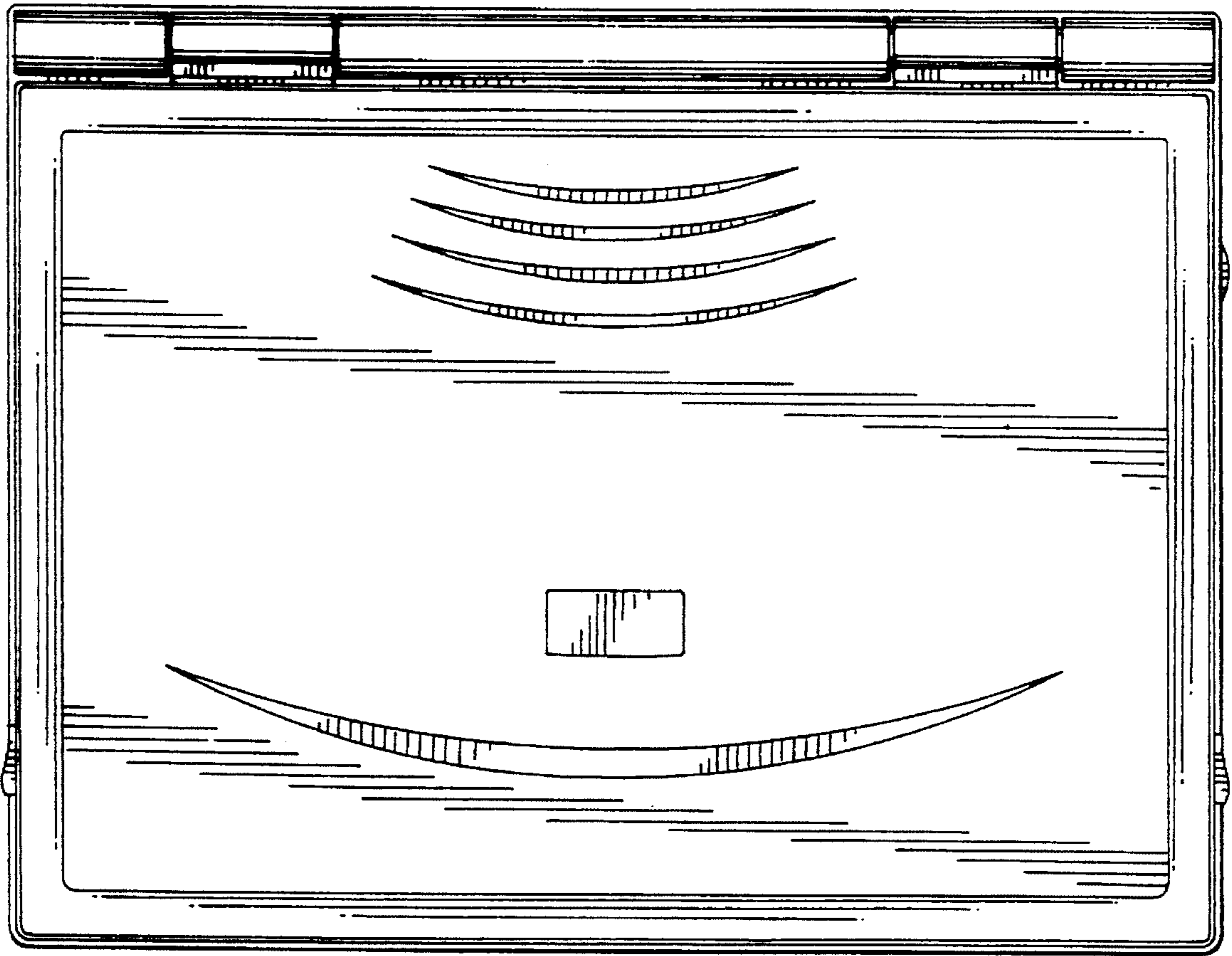

Fig.4

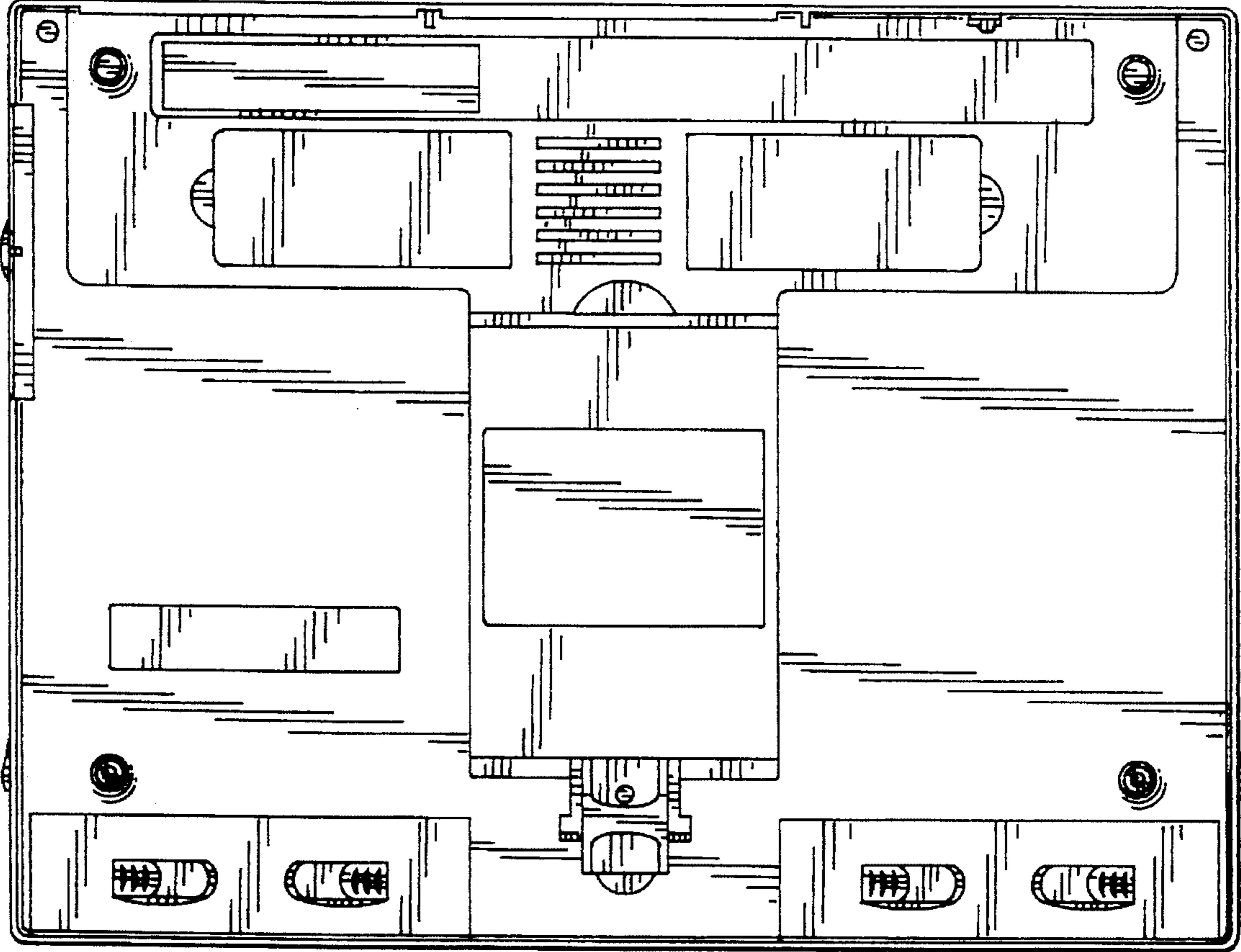

Fig.5

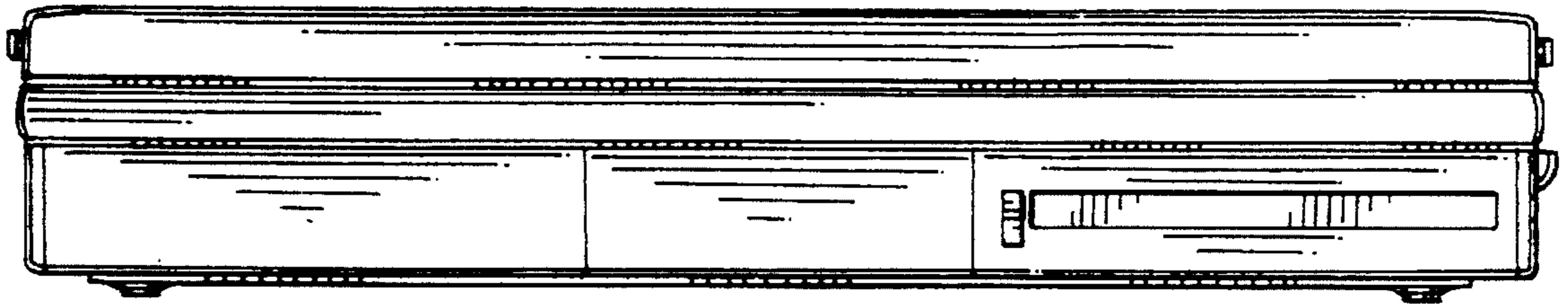

Fig.6

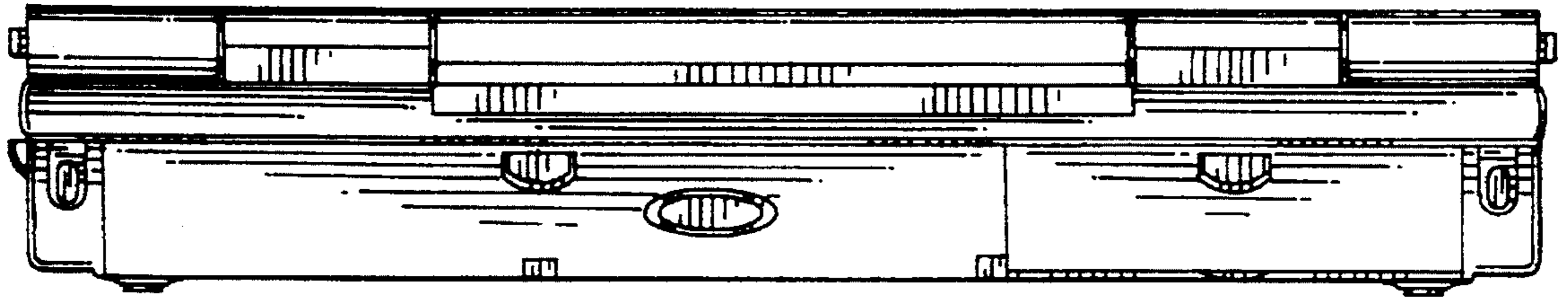

Fig.7

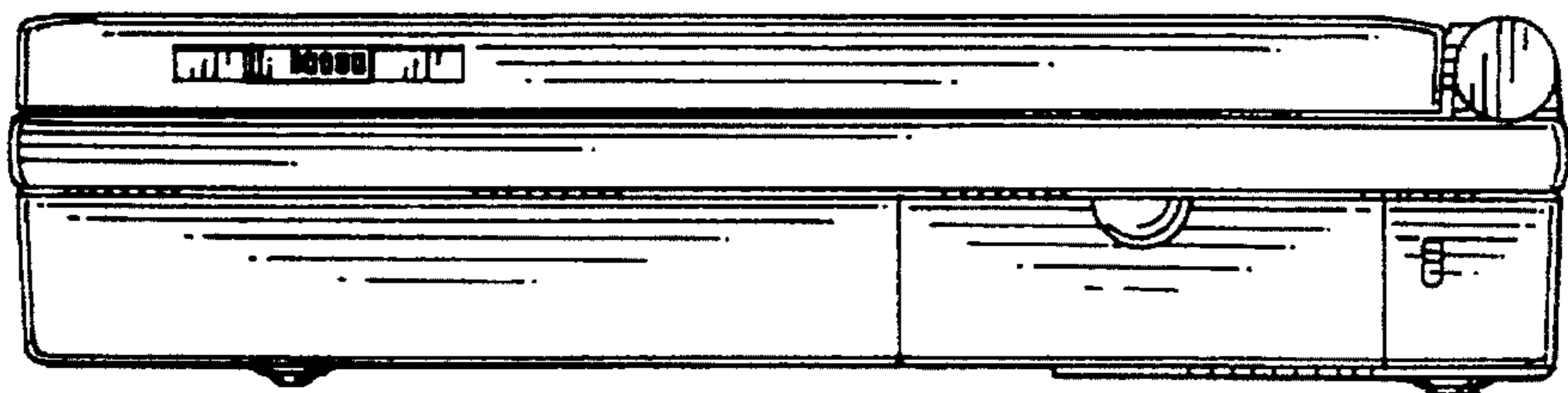

Fig.8

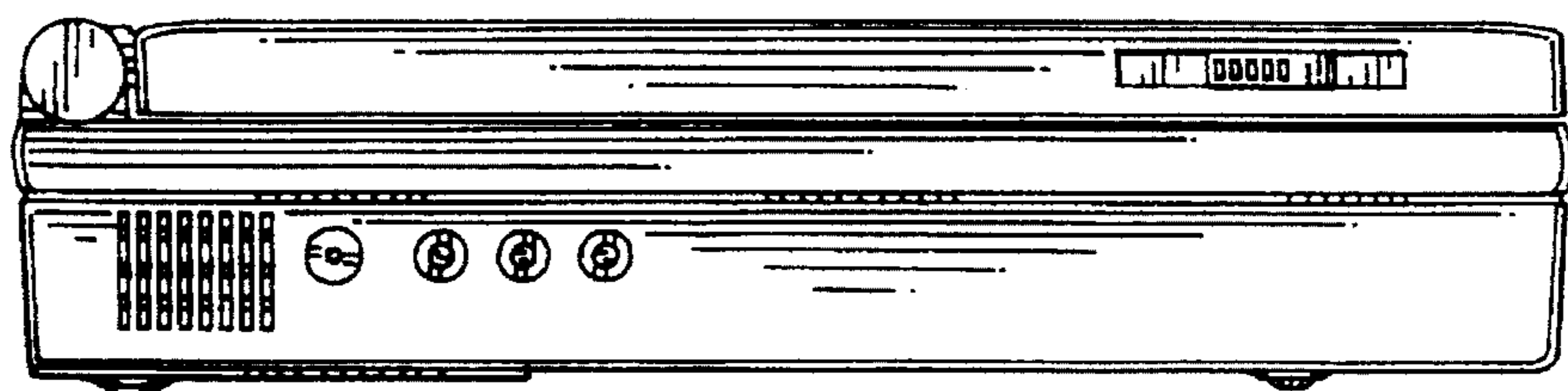

Fig.9