



US00D365286S

United States Patent [19] Florian

[11] Patent Number: **Des. 365,286**
[45] Date of Patent: ****Dec. 19, 1995**

[54] **WRISTWATCH**

5,285,430 2/1994 Decker 368/281

[75] Inventor: **Strasser Florian**, Meinisberg,
Switzerland

FOREIGN PATENT DOCUMENTS

507868 6/1939 United Kingdom 368/280

[73] Assignee: **Concord Watch Company SA**, Bienne,
Switzerland

OTHER PUBLICATIONS

European Jeweler (G.Z.)—Feb. 1983—p. 90—Watches at top left.

[**] Term: **14 Years**

Primary Examiner—Nelson C. Holtje
Attorney, Agent, or Firm—McGlew and Tuttle

[21] Appl. No.: **927,181**

[22] Filed: **Aug. 7, 1992**

[57] CLAIM

[30] Foreign Application Priority Data

The ornamental design for a wristwatch, as shown and described.

Feb. 11, 1992 [XH] Hague Agreement DMA/001703

[52] U.S. Cl. **D10/32**

DESCRIPTION

[58] Field of Search D10/1-40, 122-132;
368/280-282, 285, 276-277

FIG. 1 is a top plan view of a wristwatch showing my new design;

[56] References Cited

U.S. PATENT DOCUMENTS

D. 69,576	3/1926	Eppenstein	D10/39
D. 240,411	7/1976	Haber	D10/32
D. 263,378	3/1982	Fukumura	D10/39
D. 286,515	11/1986	Lai	D10/32
D. 295,965	5/1988	Murphy	D10/32
D. 313,187	12/1990	Müller	D10/39
D. 337,067	7/1993	Patterson	D10/30
1,798,619	3/1931	Mealy	368/282

FIG. 2 is a bottom plan view thereof;

FIG. 3 is a right side view of my new watch design showing the curvature of the case and the watch crystal in the direction of the watch 6 to the watch 12;

FIG. 4 is a left side view of the watch of FIG. 1 showing the curvature of the watch case and watch crystal from the direction of the watch 6 to the watch 12;

FIG. 5 is a left side elevational view of FIG. 4; and,

FIG. 6 is a left side elevational view of FIG. 3.

1 Claim, 3 Drawing Sheets

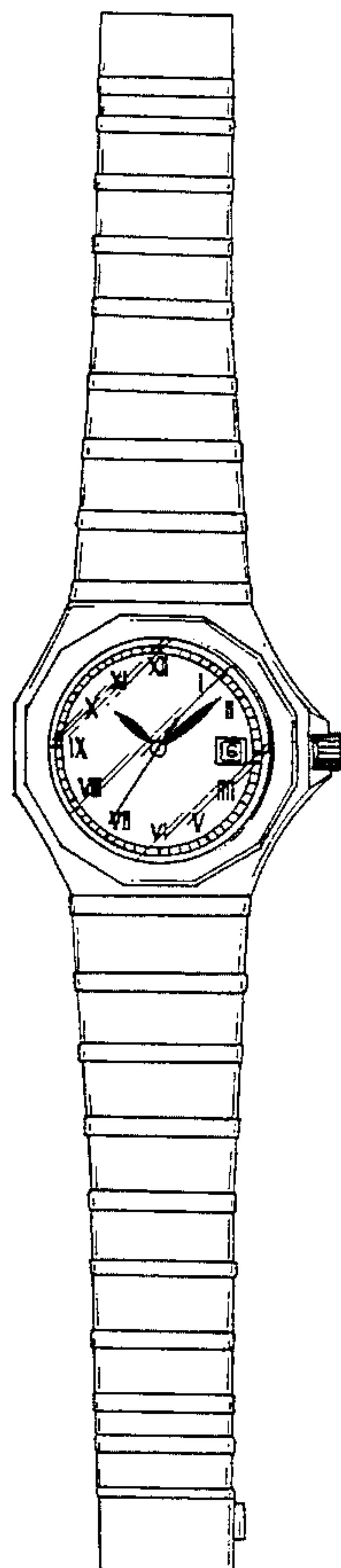

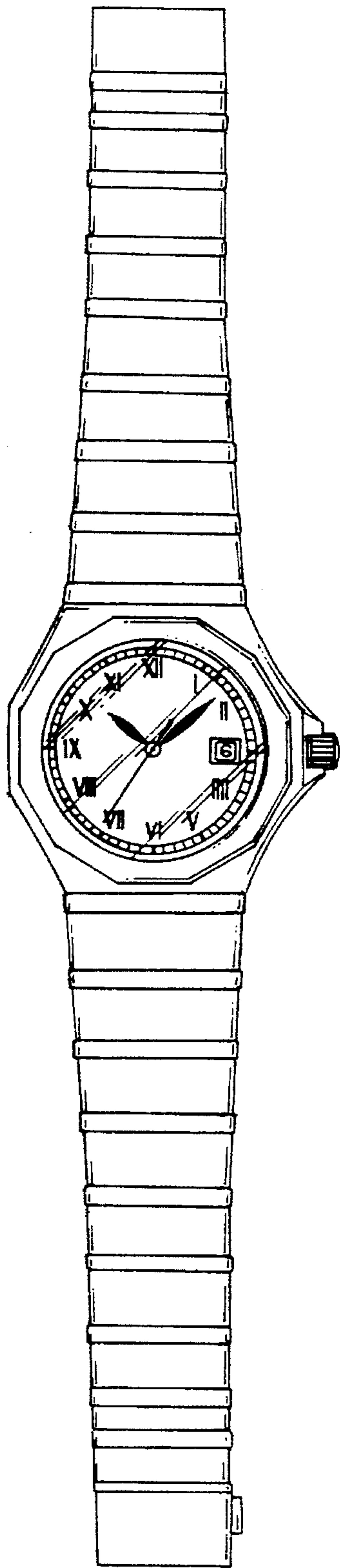

FIG. 1

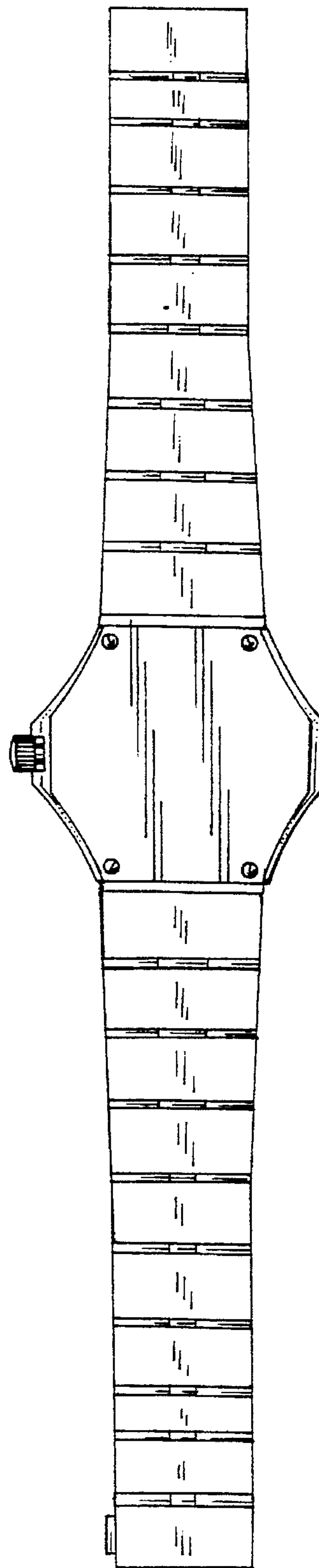

FIG. 2

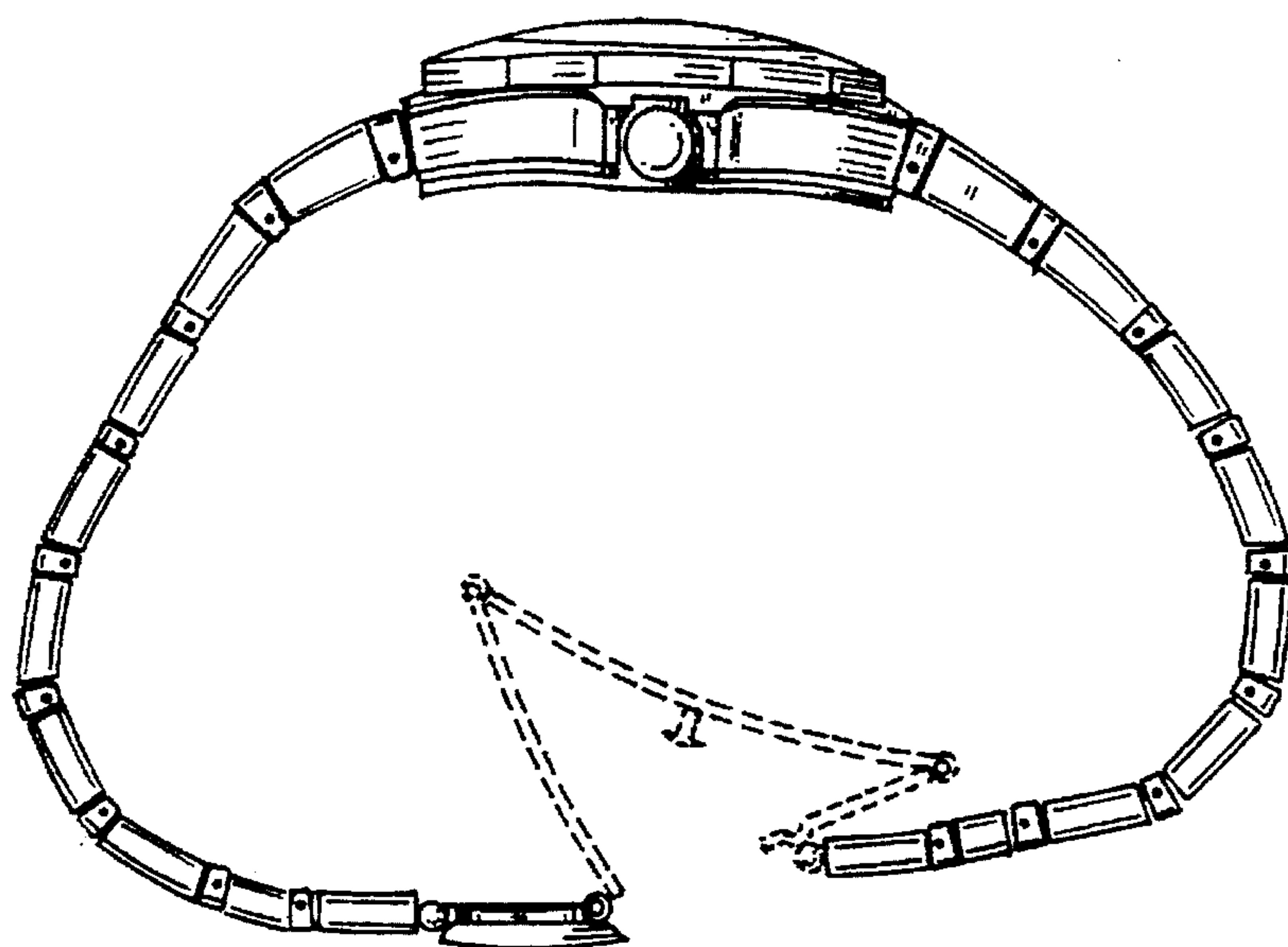

FIG. 3

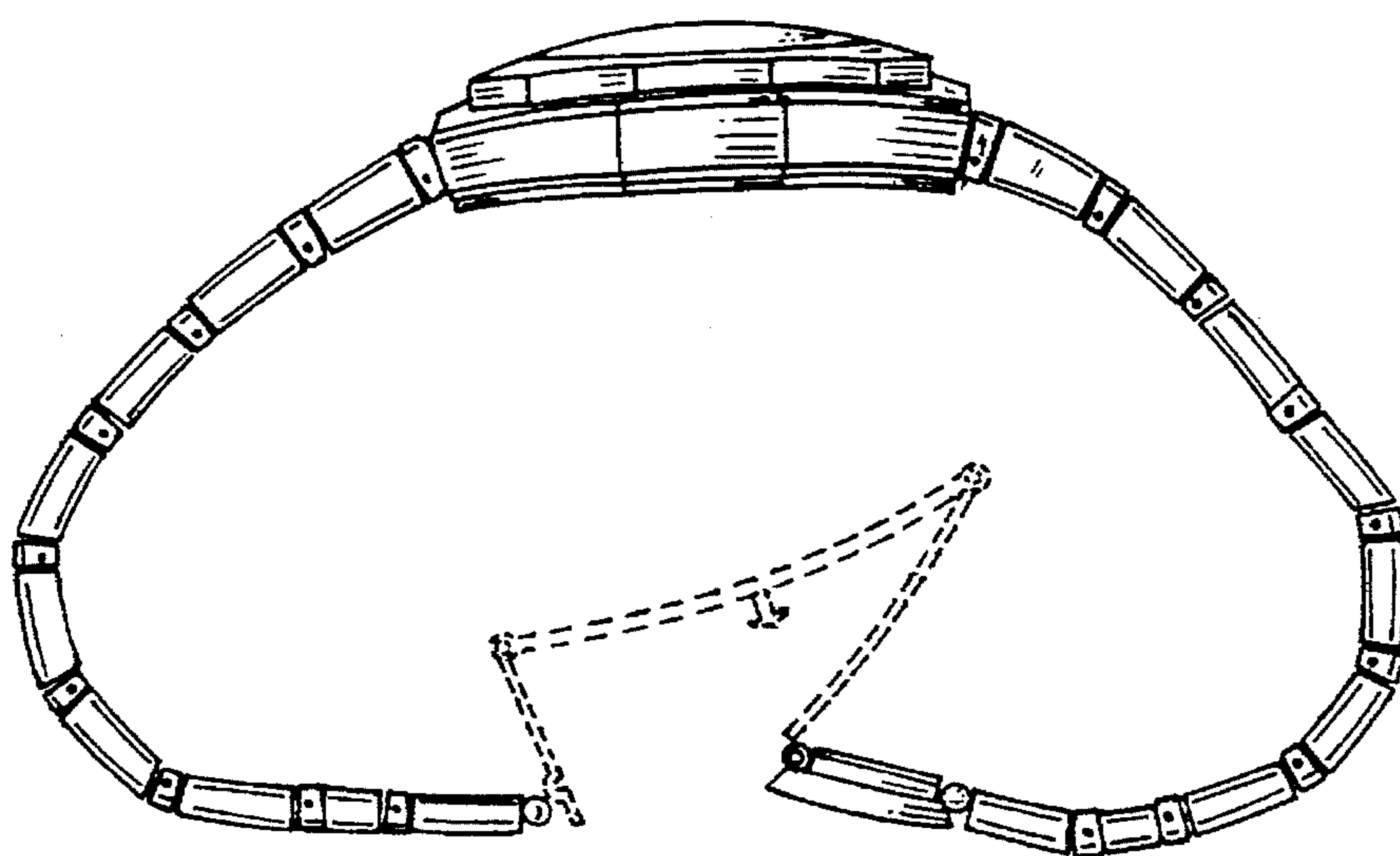

FIG. 4

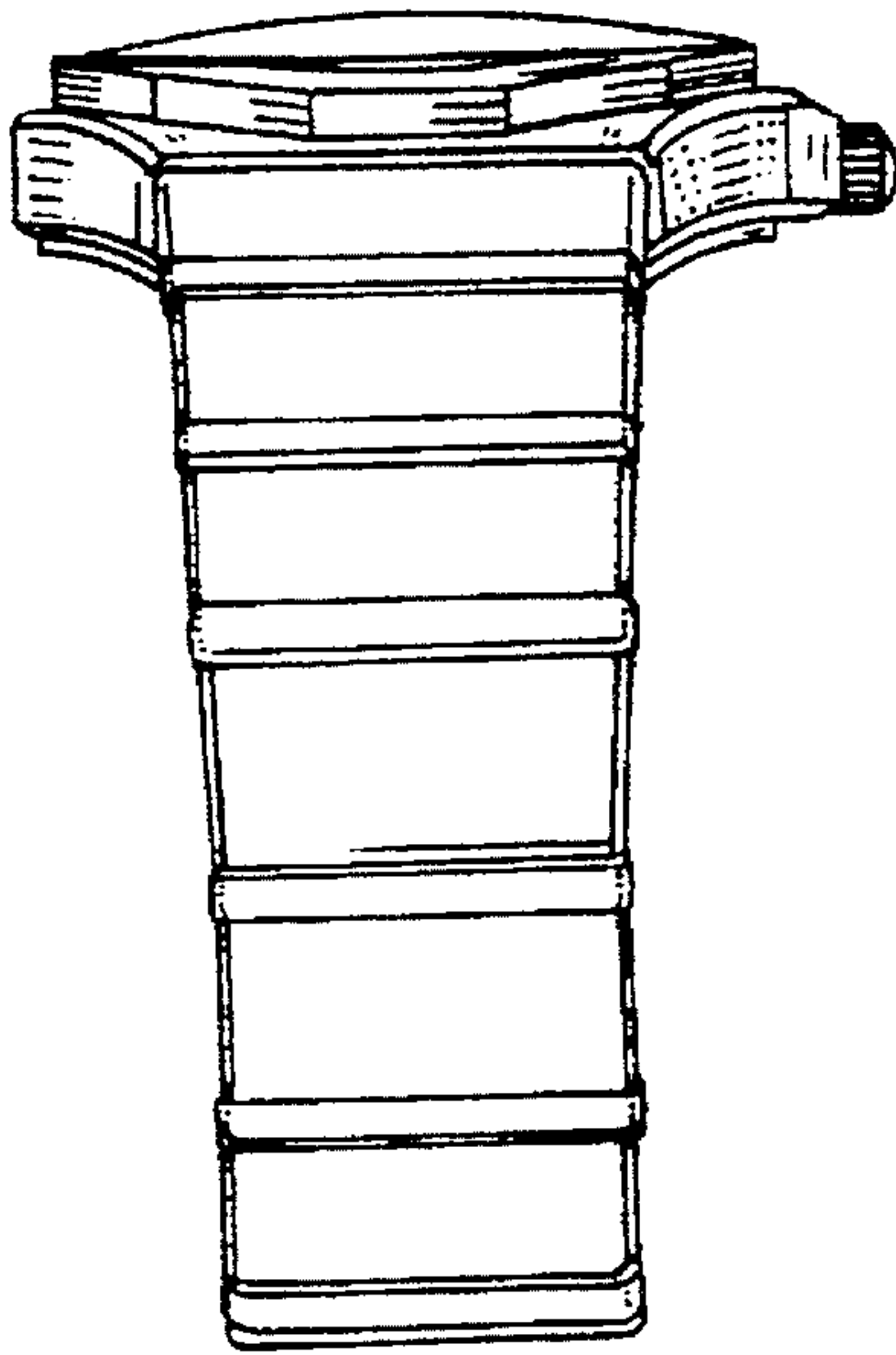

FIG. 6

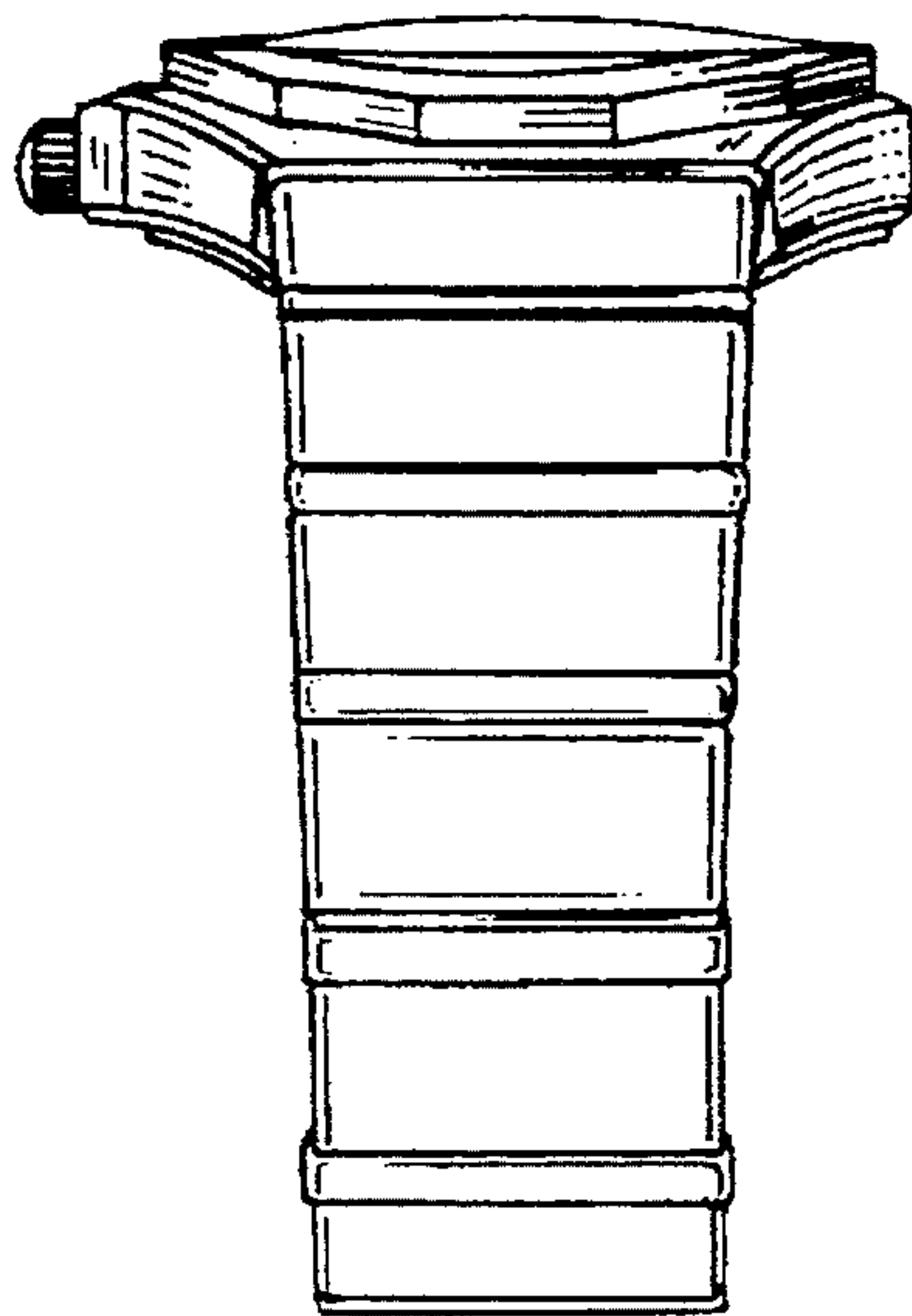

FIG. 5

UNITED STATES PATENT AND TRADEMARK OFFICE
CERTIFICATE OF CORRECTION

PATENT NO. : Des. 365,286
DATED : December 19, 1995
INVENTOR(S) : Florian STRASSER

It is certified that error appears in the above-identified patent and that said Letters Patent is hereby corrected as shown below:

On the title page, under item [19], change "Florian" to --Strasser--.

On the title page, item [75], change "Strasser Florian" to --Florian Strasser--.

Signed and Sealed this
Eleventh Day of June, 1996

Attest:



BRUCE LEHMAN

Attesting Officer

Commissioner of Patents and Trademarks