



US00D365248S

**United States Patent** [19]  
**Falzarano**

[11] **Patent Number:** **Des. 365,248**  
[45] **Date of Patent:** **\*\*Dec. 19, 1995**

[54] **CUP DESIGN WITH WATERFALL HANDLE**

[75] Inventor: **James Falzarano**, Melrose, Mass.

[73] Assignee: **Comet Products, Inc.**, Chelmsford, Mass.

[\*\*] Term: **14 Years**

[21] Appl. No.: **26,891**

[22] Filed: **Aug. 8, 1994**

[52] **U.S. Cl.** ..... **D7/533; D7/529**

[58] **Field of Search** ..... **D7/509, 510, 511, D7/512, 513, 507, 514, 515, 533, 534, 535, 536, 523, 529, 531, 532, 619, 622, 623**

[56] **References Cited**

**U.S. PATENT DOCUMENTS**

D. 36,330	5/1903	Johnson	.....	D7/536
D. 90,120	6/1933	McNash	.....	D7/523
D. 219,472	12/1970	Piker	.....	D7/533
D. 276,488	11/1984	Durand	.....	D7/535
D. 299,605	1/1989	Durand	.....	D7/535
3,495,736	2/1970	Ragetili	.....	D7/529 X

**OTHER PUBLICATIONS**

Mug #3530, 807 Monongah Glass Co. Catalog 1925.  
Mug #166 407 Capped Monongah Glass Co. Catalog 1925.

*Primary Examiner*—Alan P. Douglas

*Assistant Examiner*—M. N. Pandozzi  
*Attorney, Agent, or Firm*—Pearson & Pearson

[57] **CLAIM**

The ornamental design for the cup design with waterfall handle, as shown and described.

**DESCRIPTION**

FIG. 1 is a top left side perspective view of the cup design with waterfall handle showing my new design;

FIG. 2 is a front elevational view of the cup design with waterfall handle thereof;

FIG. 3 is a right side elevational view of the cup design with waterfall handle thereof;

FIG. 4 is a rear elevational view of the cup design with waterfall handle thereof;

FIG. 5 is a left side elevational view of the cup design with waterfall handle thereof;

FIG. 6 is a top plan view of the cup design with waterfall handle thereof; and,

FIG. 7 is a bottom plan view of the cup design with waterfall handle thereof.

**1 Claim, 4 Drawing Sheets**

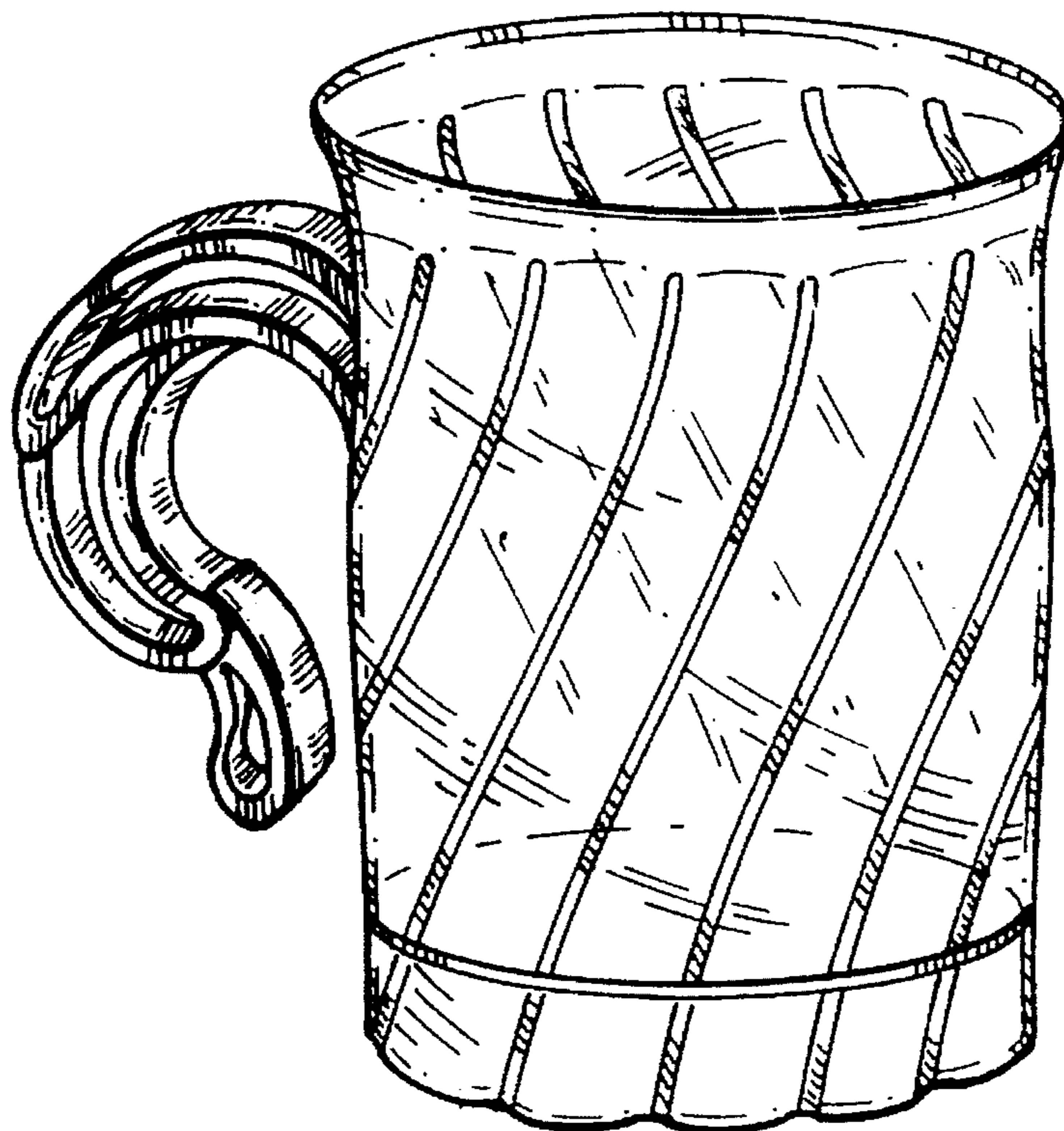

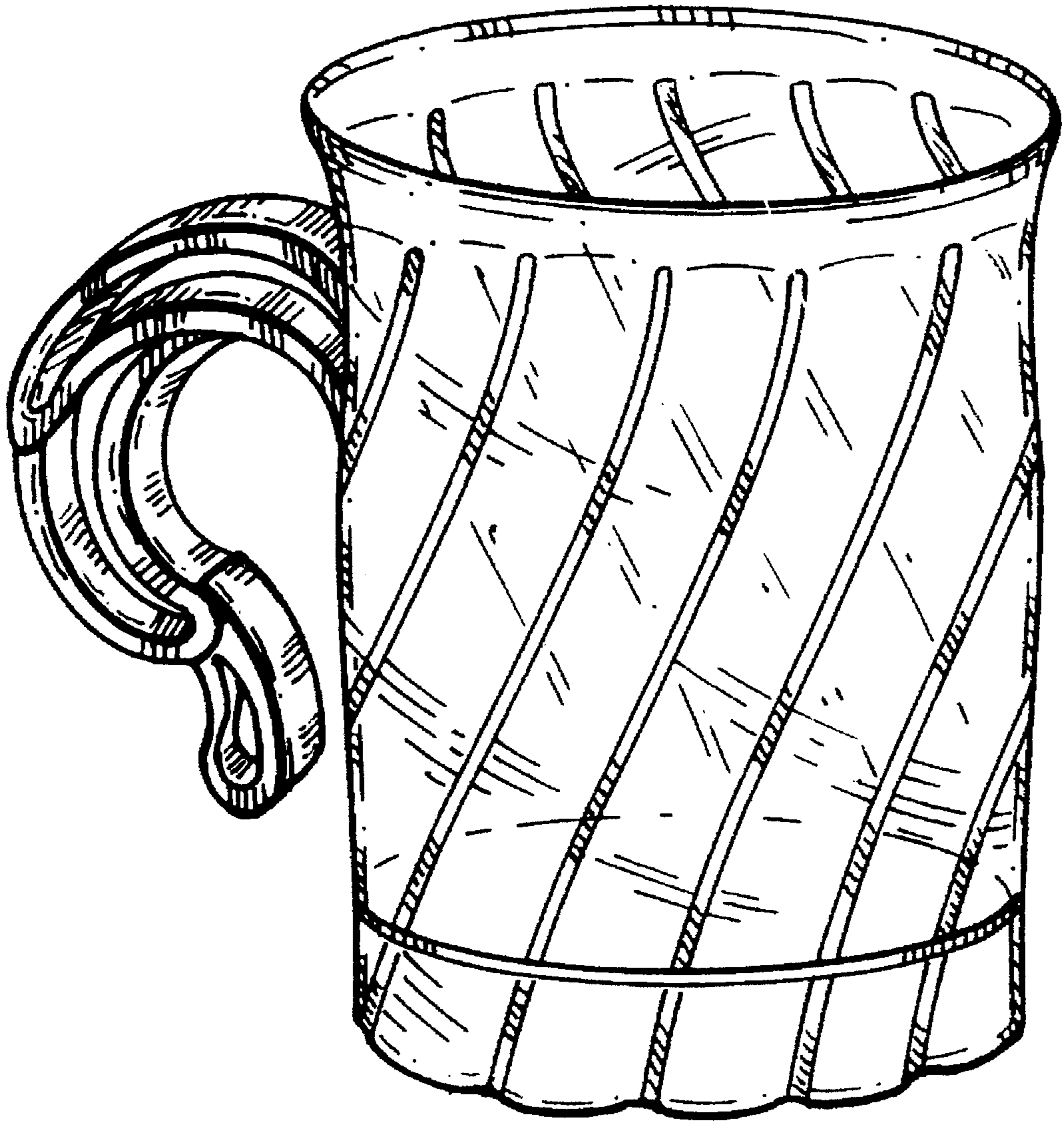

FIG. 1

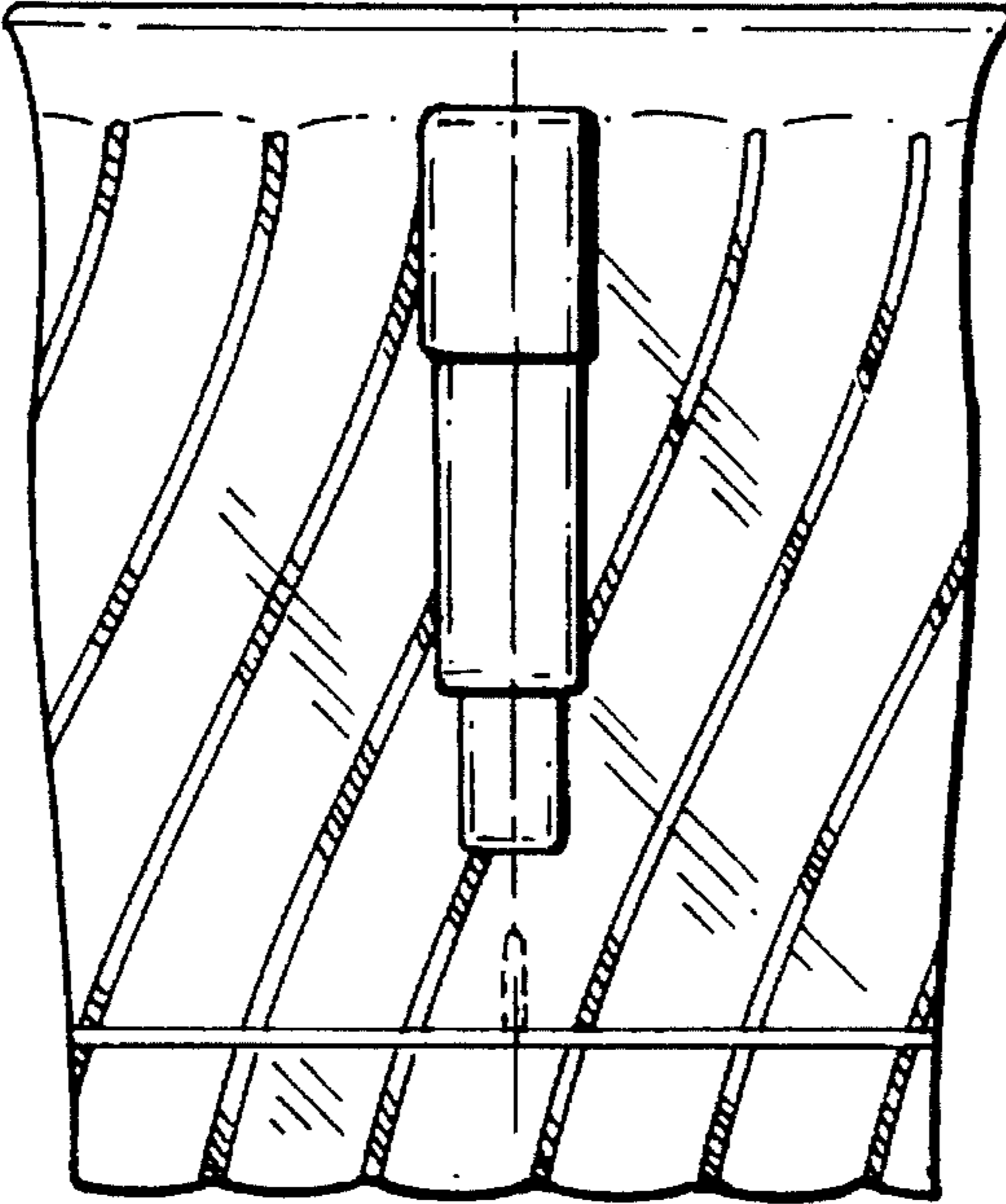

FIG. 2

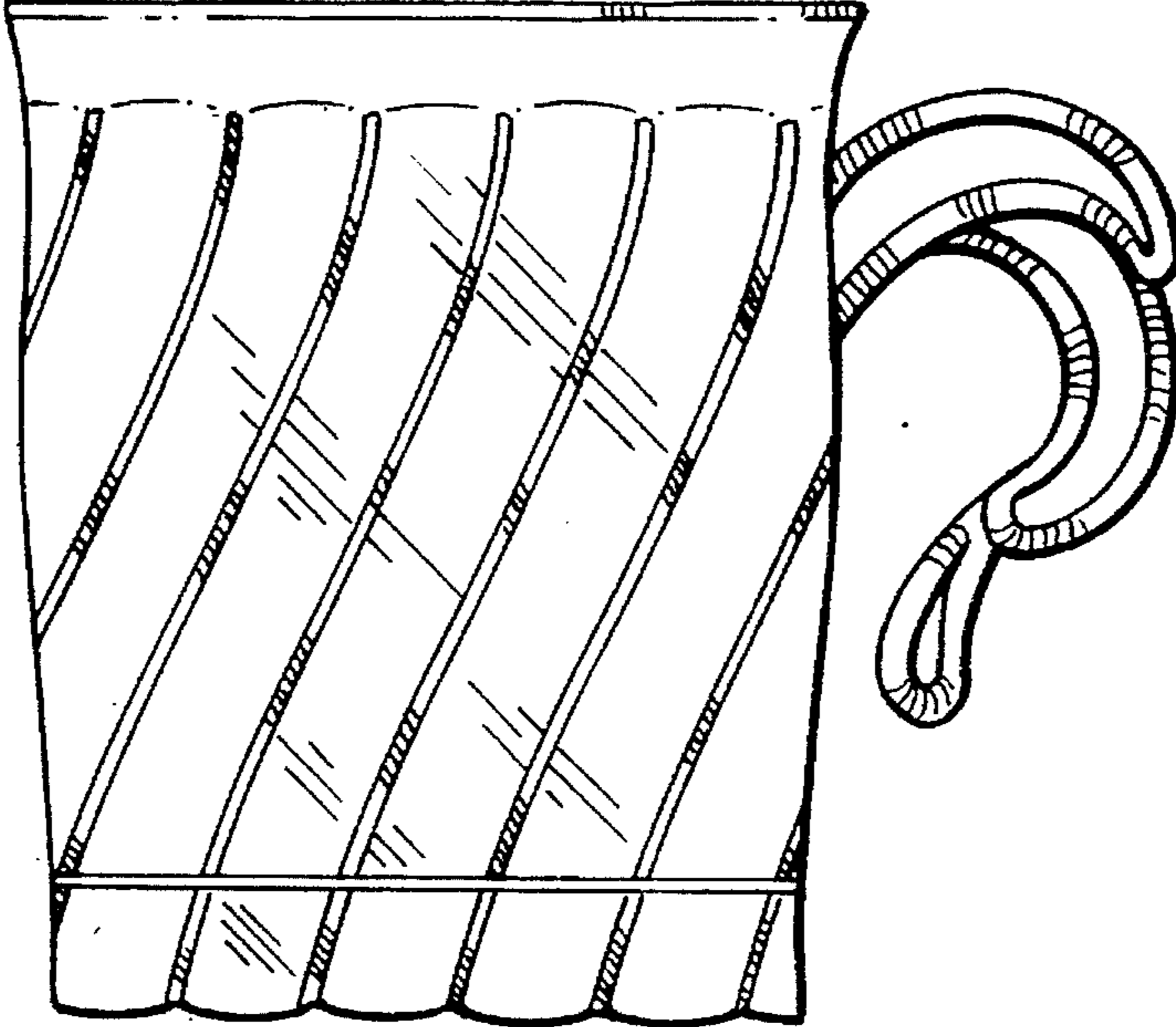

FIG. 3

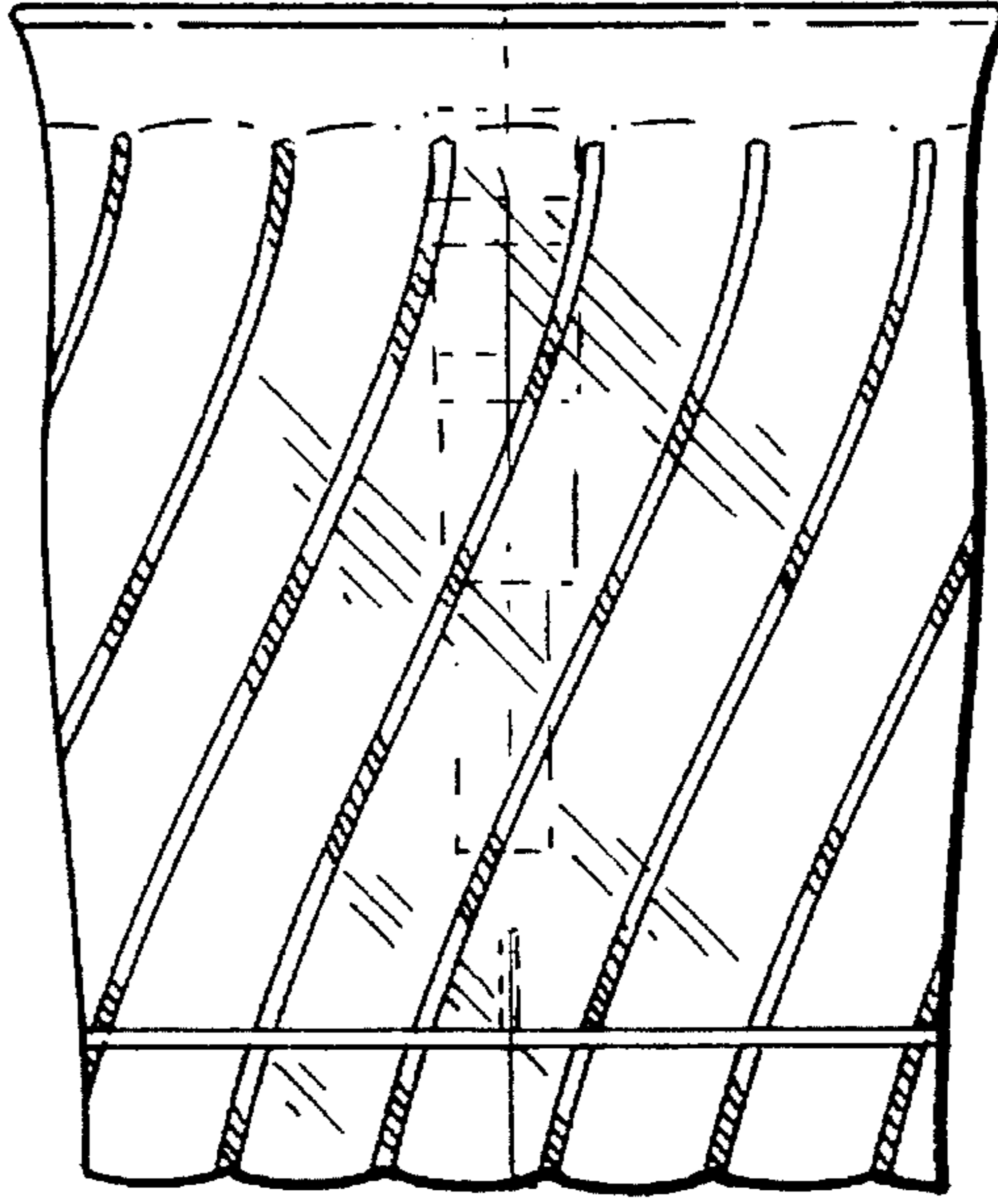

FIG. 4

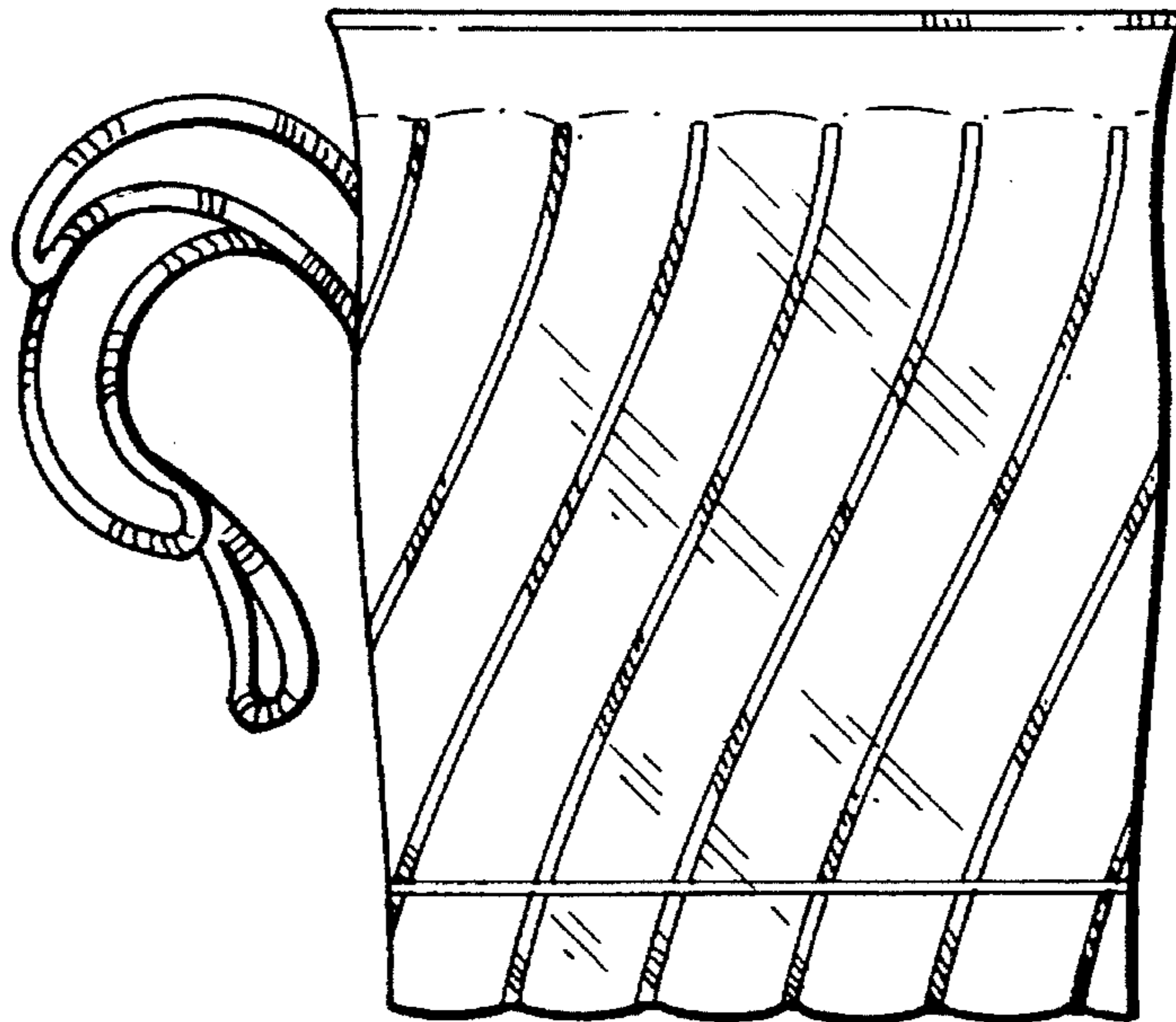

FIG. 5

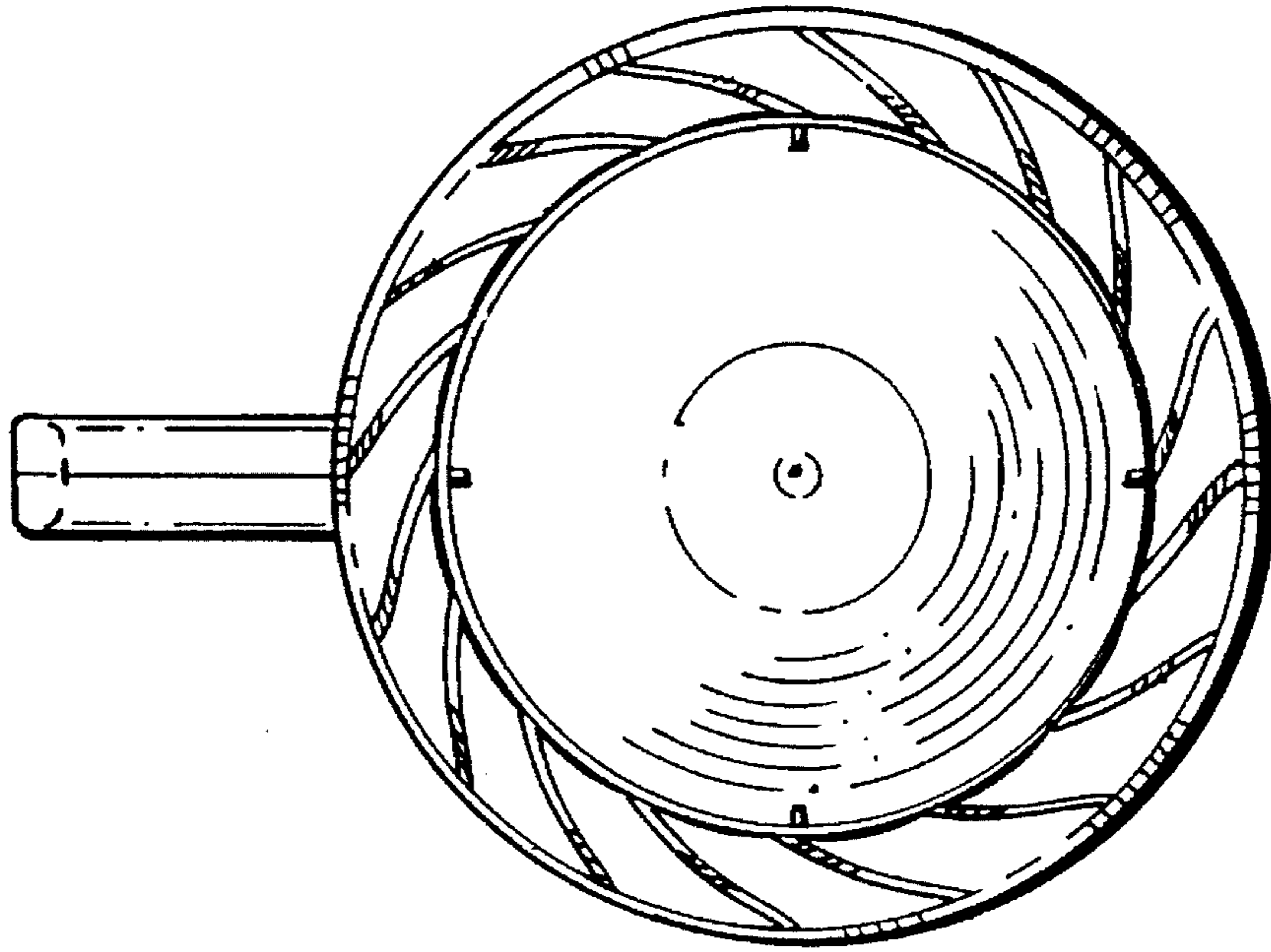

FIG. 6

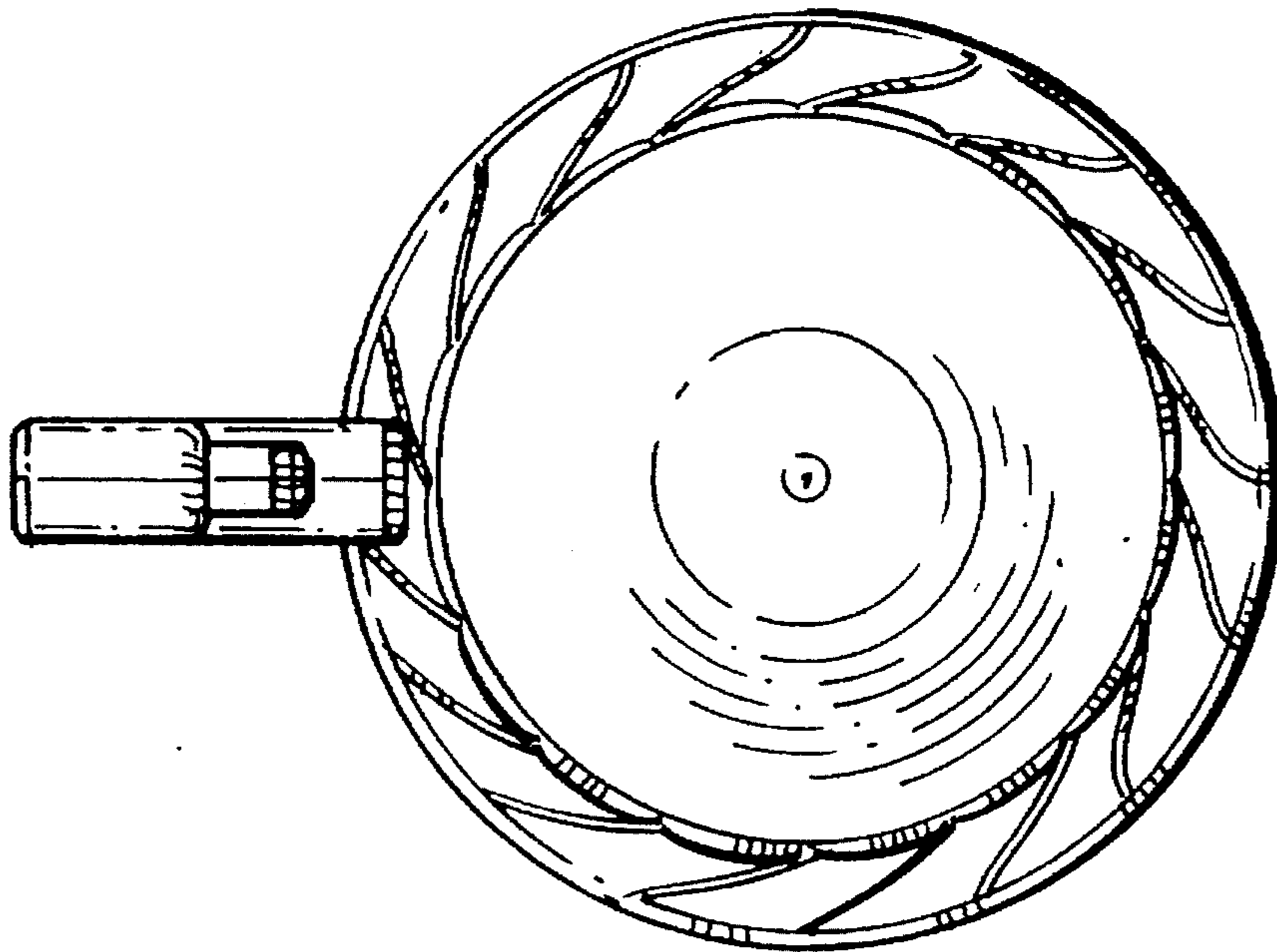

FIG. 7