



US00D365176S

United States Patent [19]

[11] Patent Number: **Des. 365,176**

Heinrich

[45] Date of Patent: ****Dec. 12, 1995**

[54] **ILLUMINATED LIPSTICK CASE**

5,025,354 6/1991 Kondo 362/135
5,257,704 11/1993 Gutt 206/385 X

[76] Inventor: **Vicki G. Heinrich**, 951 Conquistador St., Hanford, Calif. 93230

FOREIGN PATENT DOCUMENTS

[**] Term: **14 Years**

36749 4/1930 France 132/320
523502 4/1955 Italy 401/88

[21] Appl. No.: **19,463**

Primary Examiner—Ted Shooman

[22] Filed: **Mar. 3, 1994**

Assistant Examiner—C. Tuttle

[52] U.S. Cl. **D28/87**; D28/88; D26/38

[57] **CLAIM**

[58] **Field of Search** D28/76, 77, 85-90; D9/330, 529, 502, 504; D26/2, 4, 38; 132/312, 318, 320; 401/88, 82, 98, 95, 192, 194, 195; 362/109, 116, 118, 136, 137

The ornamental design for an illuminated lipstick case, as shown and described.

DESCRIPTION

[56] **References Cited**

FIG. 1 is a exploded front elevational view of the illuminated lipstick case showing my new design; FIG. 2 is a rear elevational view thereof; FIG. 3 is a left side elevational view thereof; FIG. 4 is a right side elevational view thereof; FIG. 5 is a top plan view thereof; FIG. 6 is a bottom plan view thereof; and, FIG. 7 is a top isometric view thereof in the assembled position.

U.S. PATENT DOCUMENTS

D. 34,040	2/1901	Chase	D26/2
D. 333,365	2/1993	Desgrippes	D28/85
2,492,439	12/1949	Philippi	401/82
2,588,024	3/1952	Manville	401/60
3,619,596	11/1971	Jackson	.	
4,032,772	6/1977	Mowbray	.	
4,888,667	12/1989	Hwang	362/109
4,905,128	2/1990	Caires	362/109

1 Claim, 4 Drawing Sheets

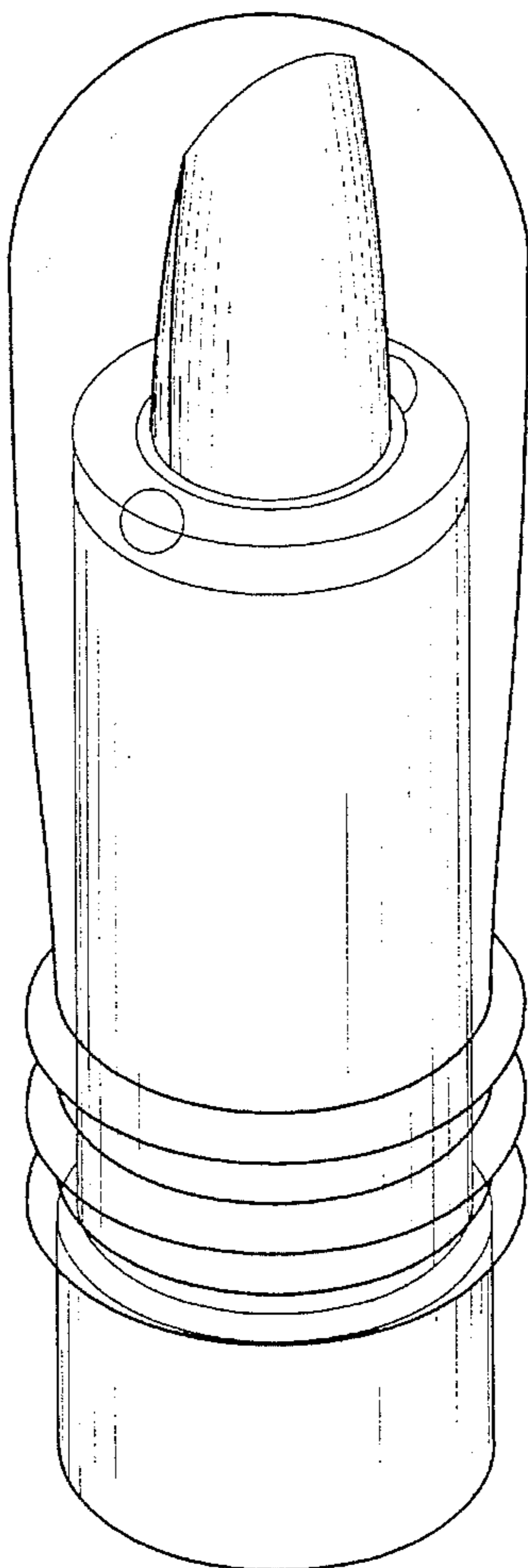

FIG. 1

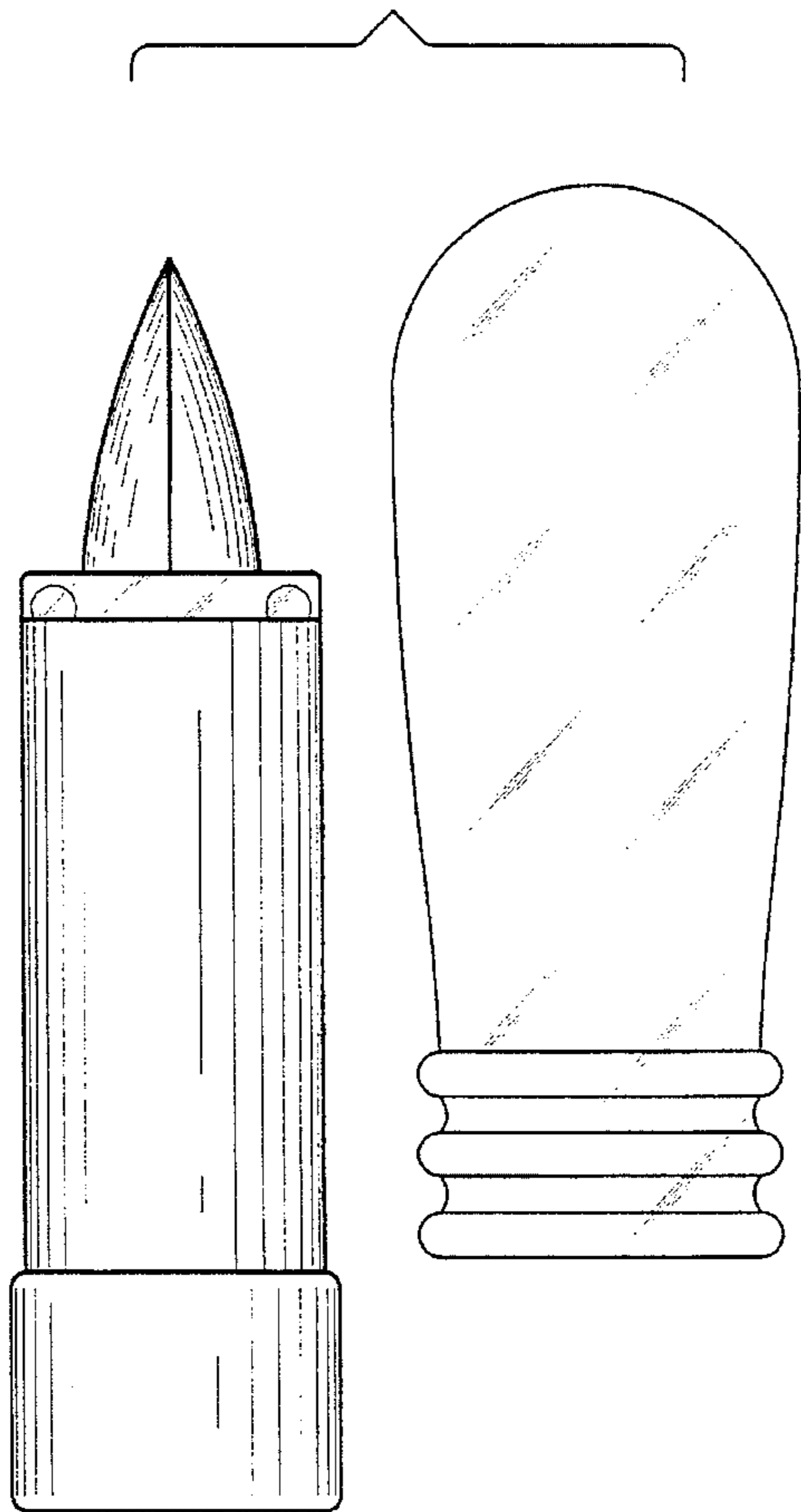

FIG. 2

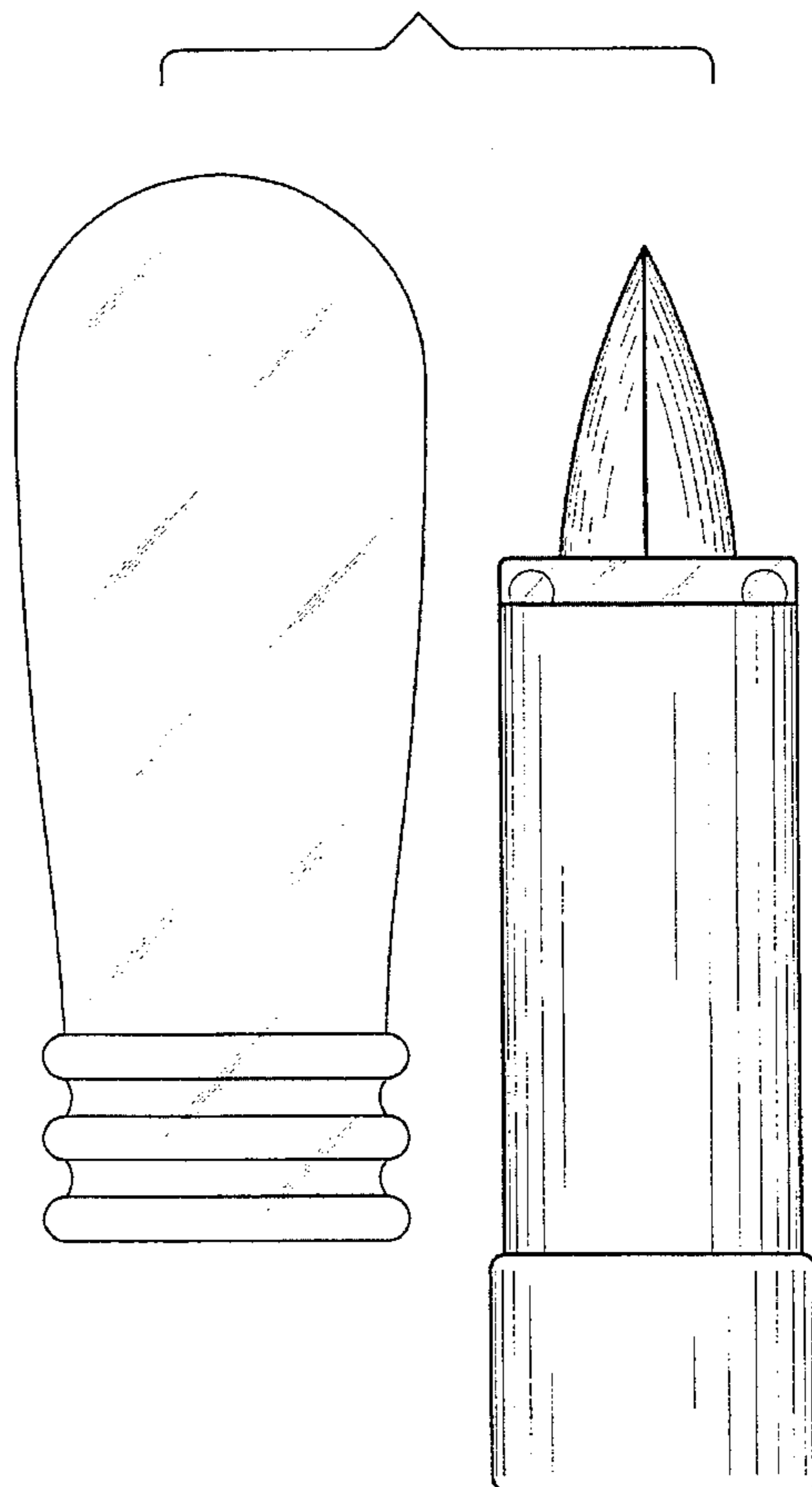

FIG. 3

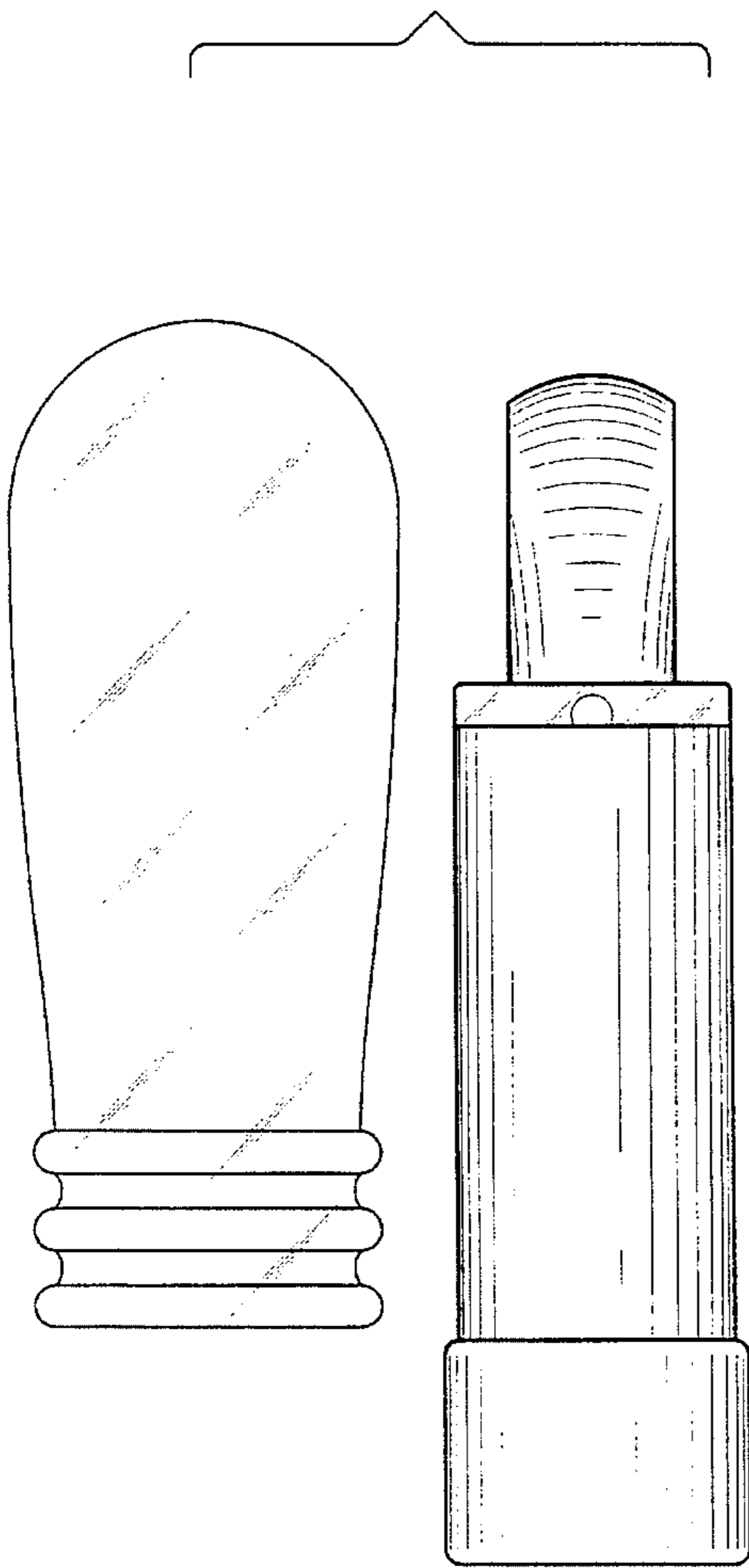

FIG. 4

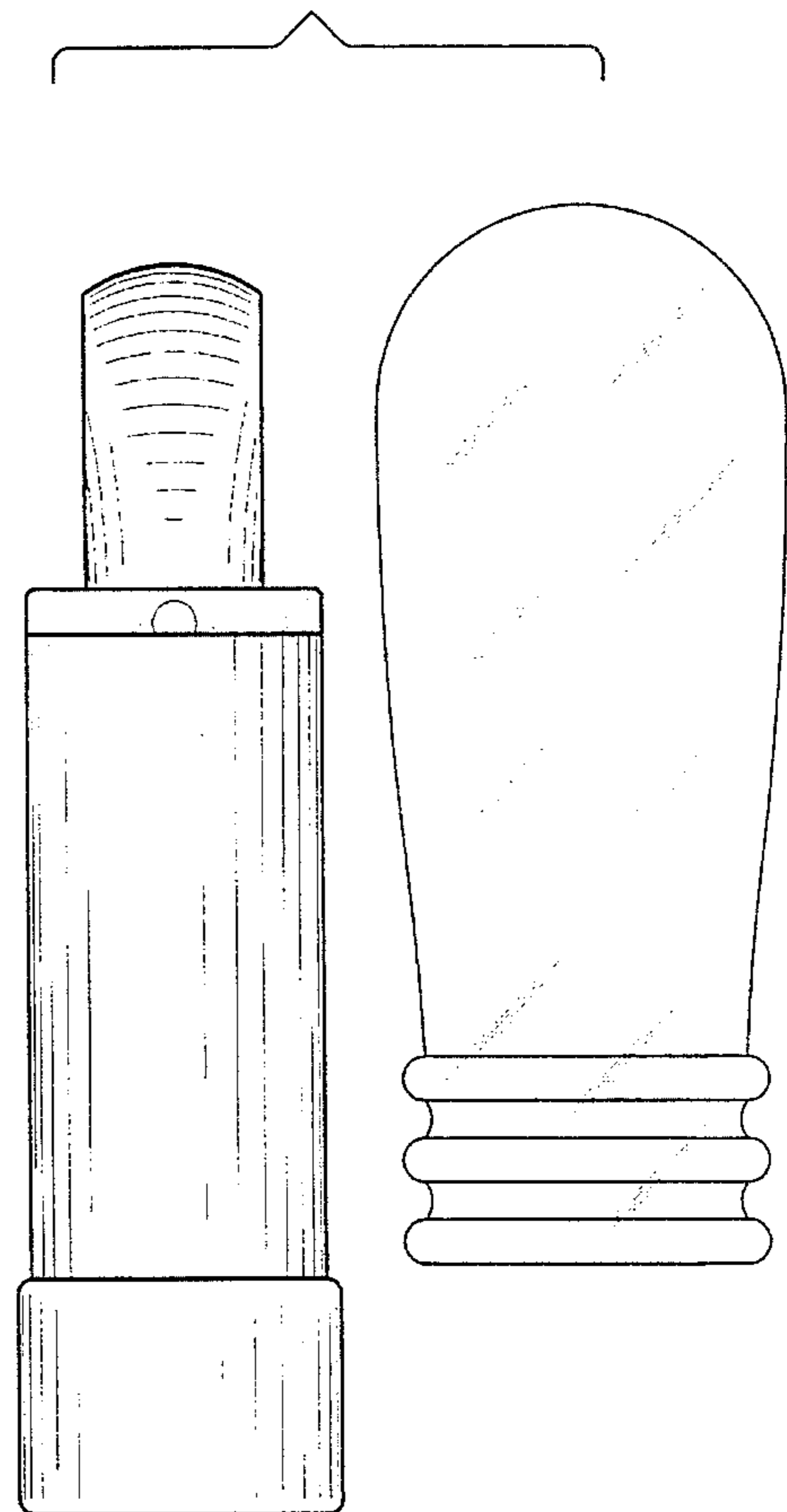

FIG. 5

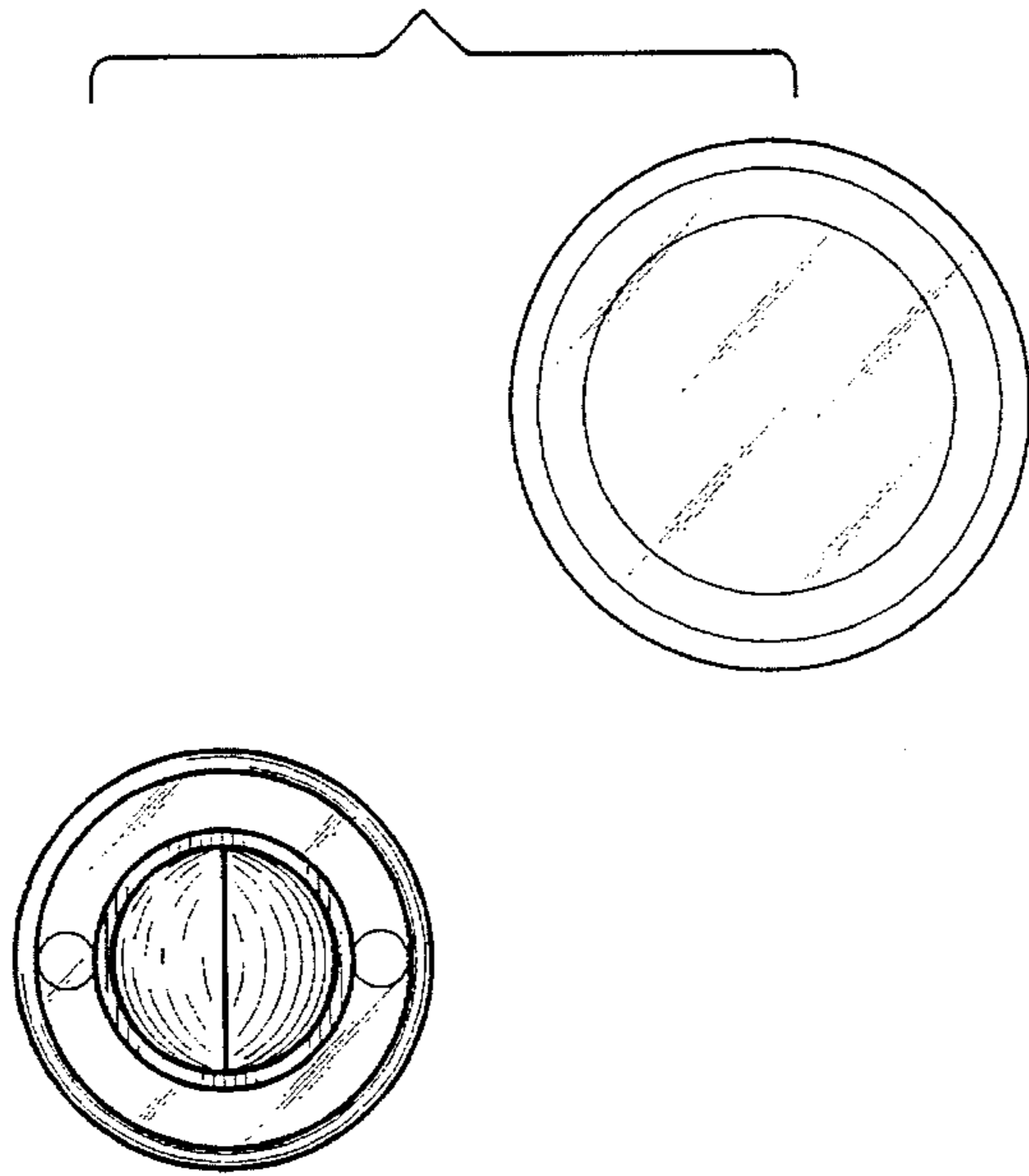

FIG. 6

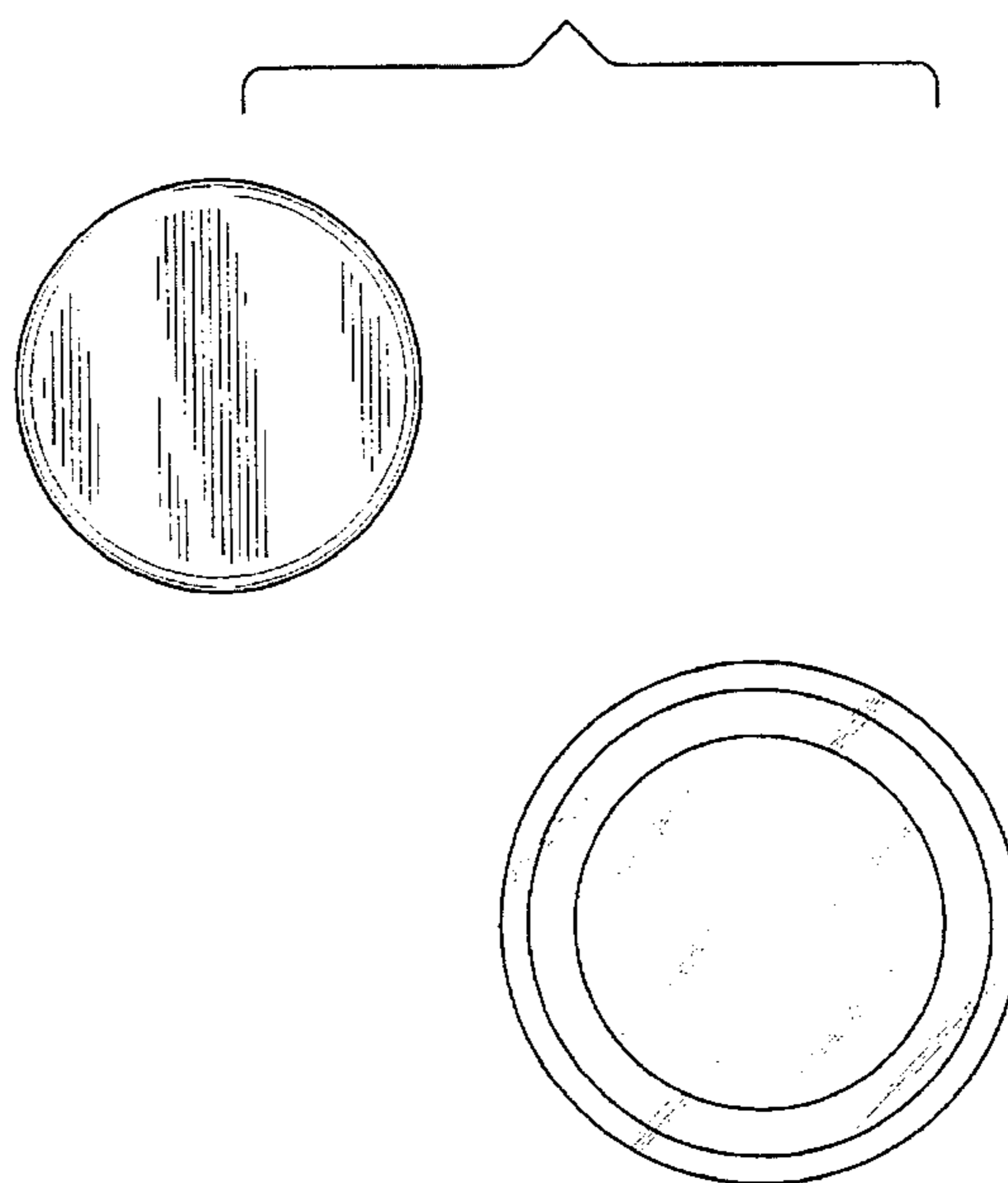

FIG. 7

