



US00D364997S

# United States Patent [19]

[11] Patent Number: **Des. 364,997**

**Steinfels, III**

[45] Date of Patent: **\*\*Dec. 12, 1995**

[54] **SPHERICAL BEVERAGE CONTAINER WITH HANDLE**

*Attorney, Agent, or Firm*—Mueller and Smith

[76] Inventor: **Victor E. Steinfels, III**, 8627 Gavington Ct., Dublin, Ohio 43017

[57] **CLAIM**

The ornamental design for spherical beverage container with handle, as shown and described.

[\*\*] Term: **14 Years**

**DESCRIPTION**

[21] Appl. No.: **25,418**

FIG. 1 is a right side view of a first embodiment of the spherical beverage container with handle showing my new design;

[22] Filed: **Jun. 30, 1994**

FIG. 2 is a rear view thereof;

[52] U.S. Cl. .... **D7/536**; D7/533; D7/515

FIG. 3 is a front view thereof;

[58] **Field of Search** ..... D7/533, 507, 510, D7/511, 514, 515, 516, 523, 524, 526, 530, 531, 535, 534, 536, 537, 619, 622, 623, 606, 533; 220/903, 411, 739

FIG. 4 is a top view thereof;

FIG. 5 is a bottom view thereof;

FIG. 6 is a right side perspective view of a second embodiment of the spherical beverage container with handle showing my new design, the left side being a mirror image;

[56] **References Cited**

**U.S. PATENT DOCUMENTS**

D. 212,110	8/1968	Ketcham	.....	D7/533
D. 215,747	10/1969	Ketcham	.....	D7/533
D. 222,628	11/1971	Beckman	.....	D7/533
D. 249,918	10/1978	Block et al.	.....	D7/536 X
D. 290,435	6/1987	Manton et al.	.....	D7/336
D. 337,242	7/1993	Steinfels, III	.....	D7/623
D. 349,216	8/1994	Steinfels, III	.....	D7/623
D. 350,873	9/1994	Duffy	.....	D7/533
D. 354,882	1/1995	Hurst et al.	.....	D7/515
3,680,330	8/1972	Canosa	.....	D7/536 X

FIG. 7 is a rear view thereof;

FIG. 8 is a front view thereof;

FIG. 9 is a top view thereof;

FIG. 10 is a bottom view thereof;

FIG. 11 is a right side perspective view of a third embodiment of the spherical beverage container with handle showing my new design, the left side being a mirror image;

FIG. 12 is a rear view thereof;

FIG. 13 is a front view thereof;

FIG. 14 is a top view thereof; and,

FIG. 15 is a bottom view thereof.

*Primary Examiner*—Alan P. Douglas  
*Assistant Examiner*—M. N. Pandozzi

**1 Claim, 3 Drawing Sheets**

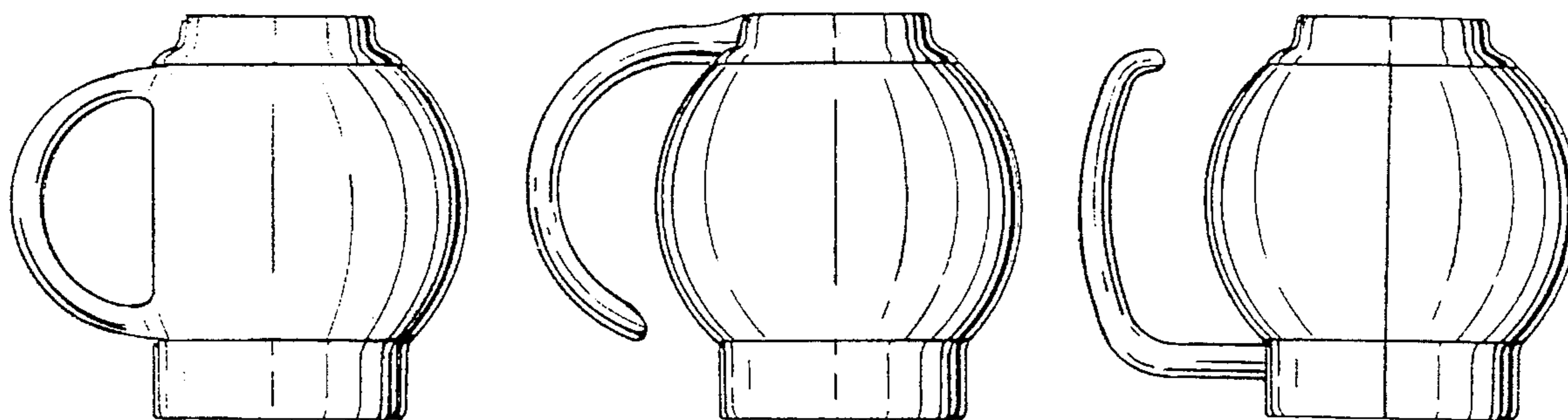

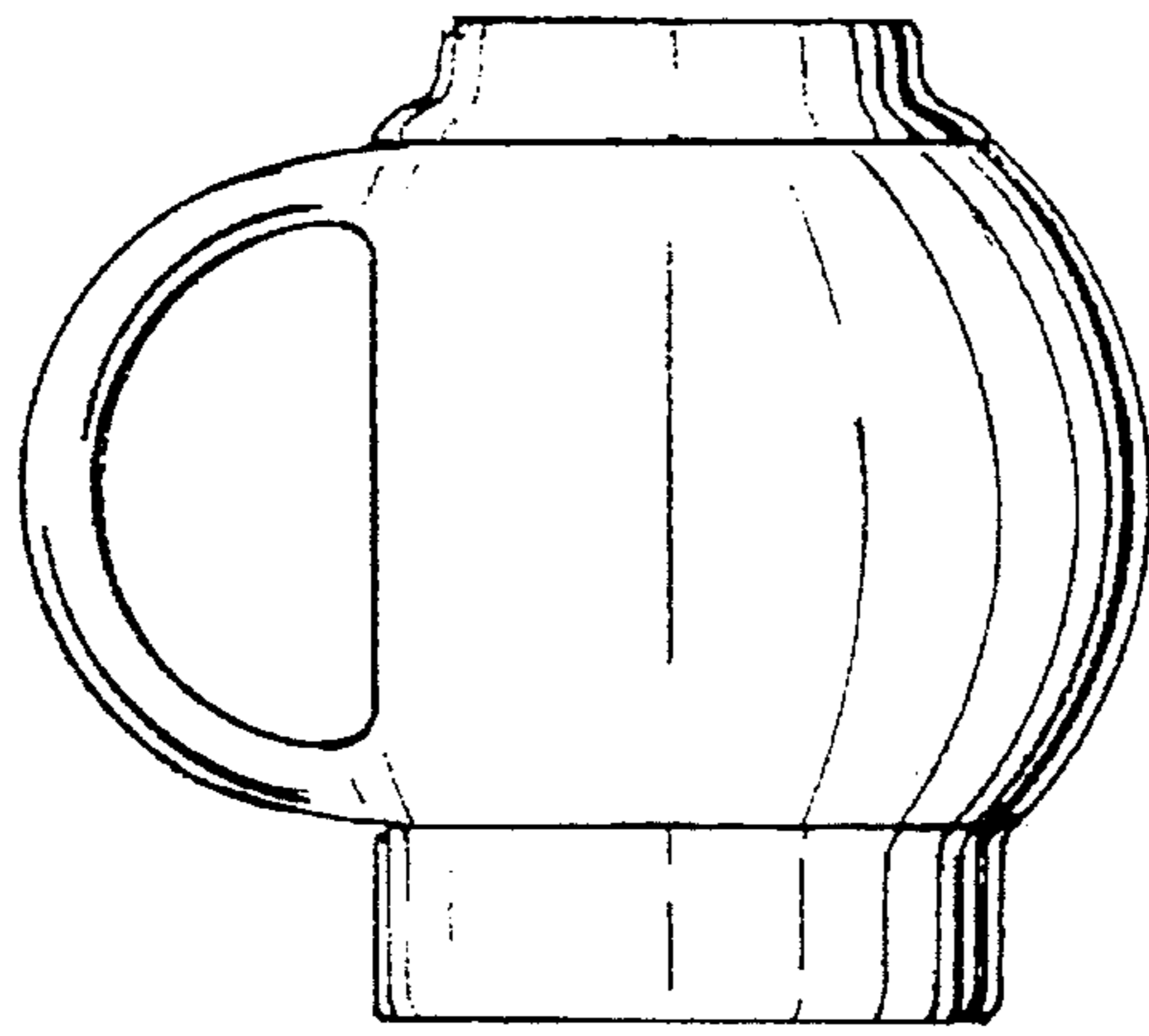

FIG. 1

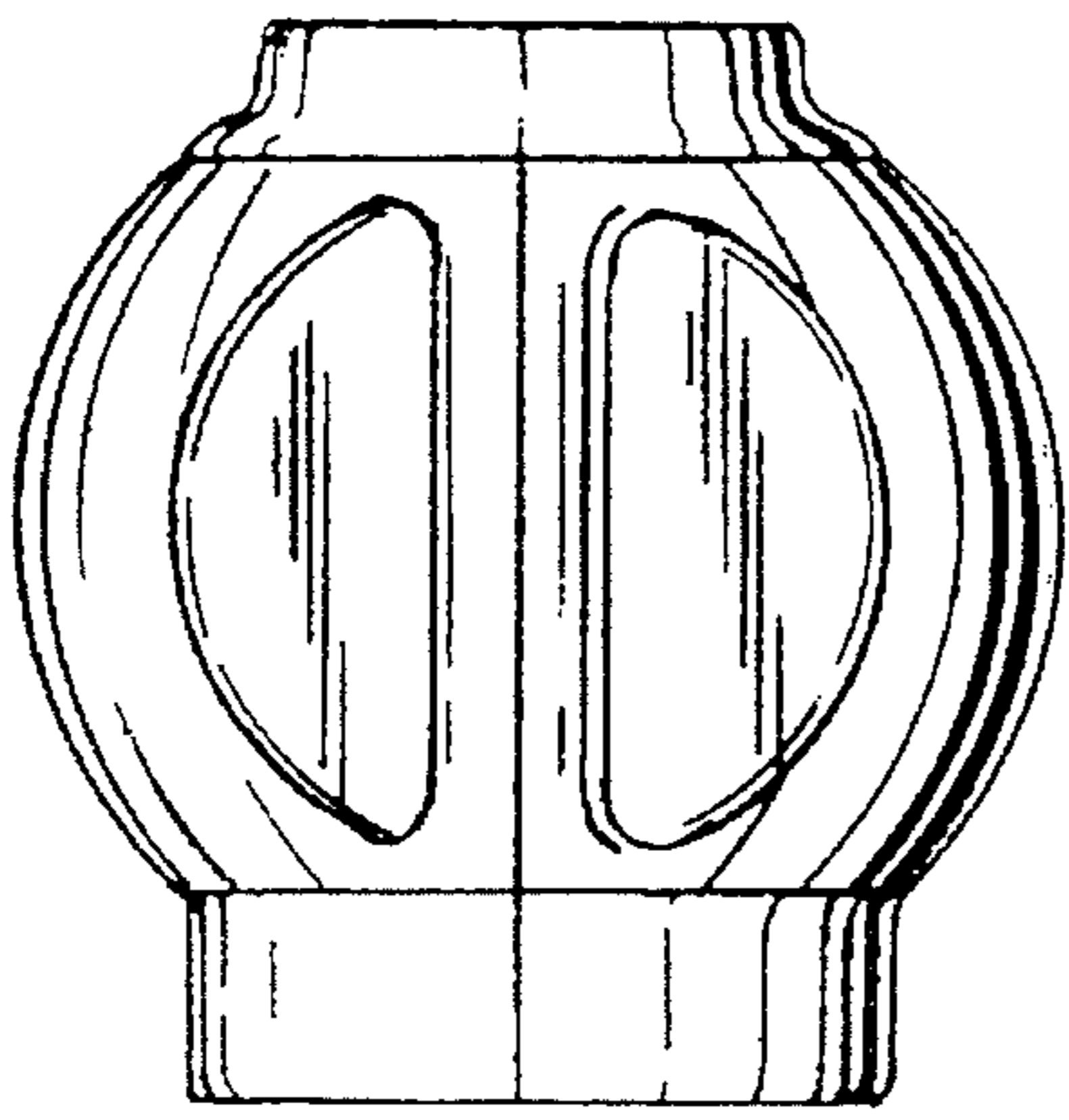

FIG. 2

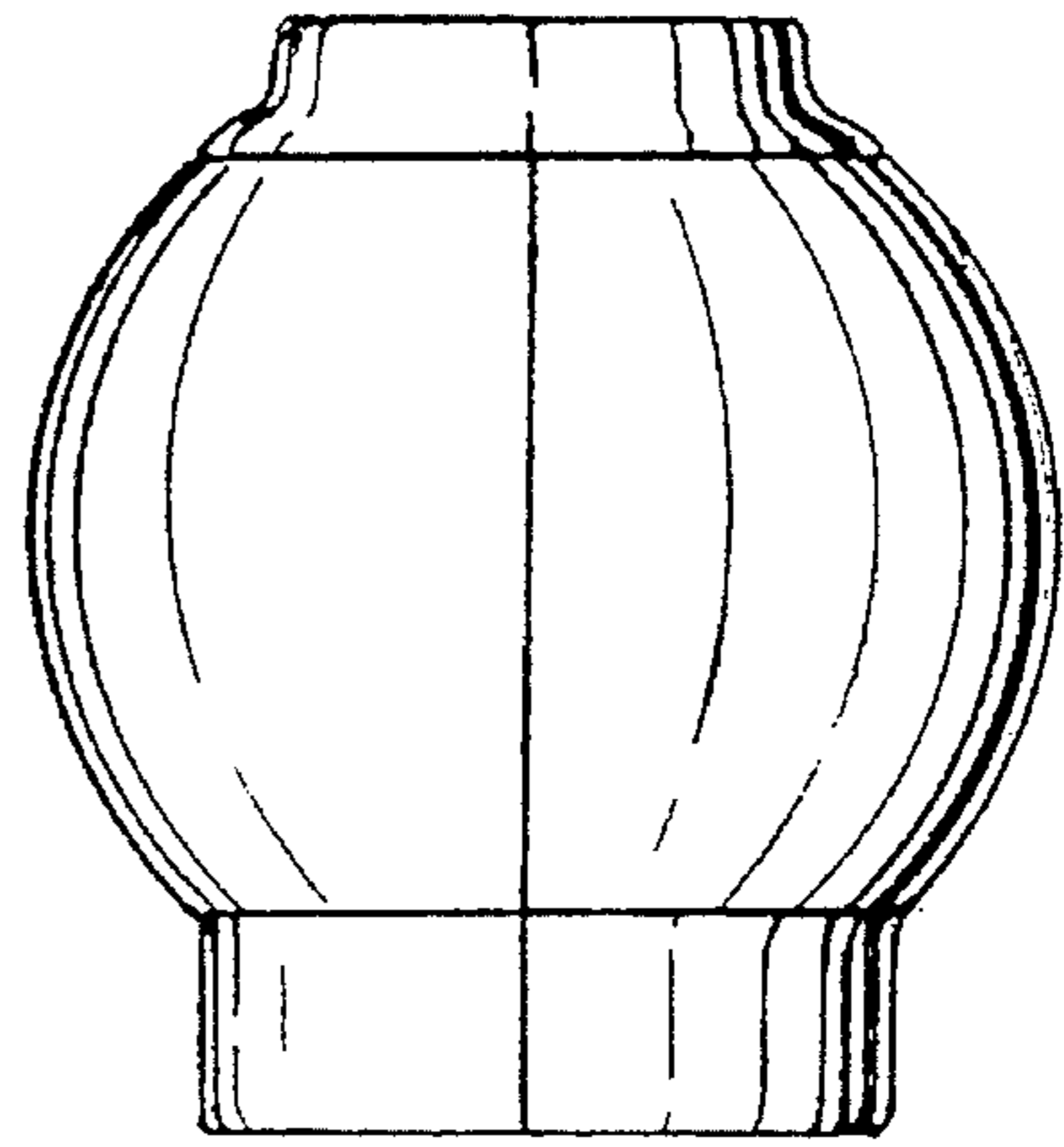

FIG. 3

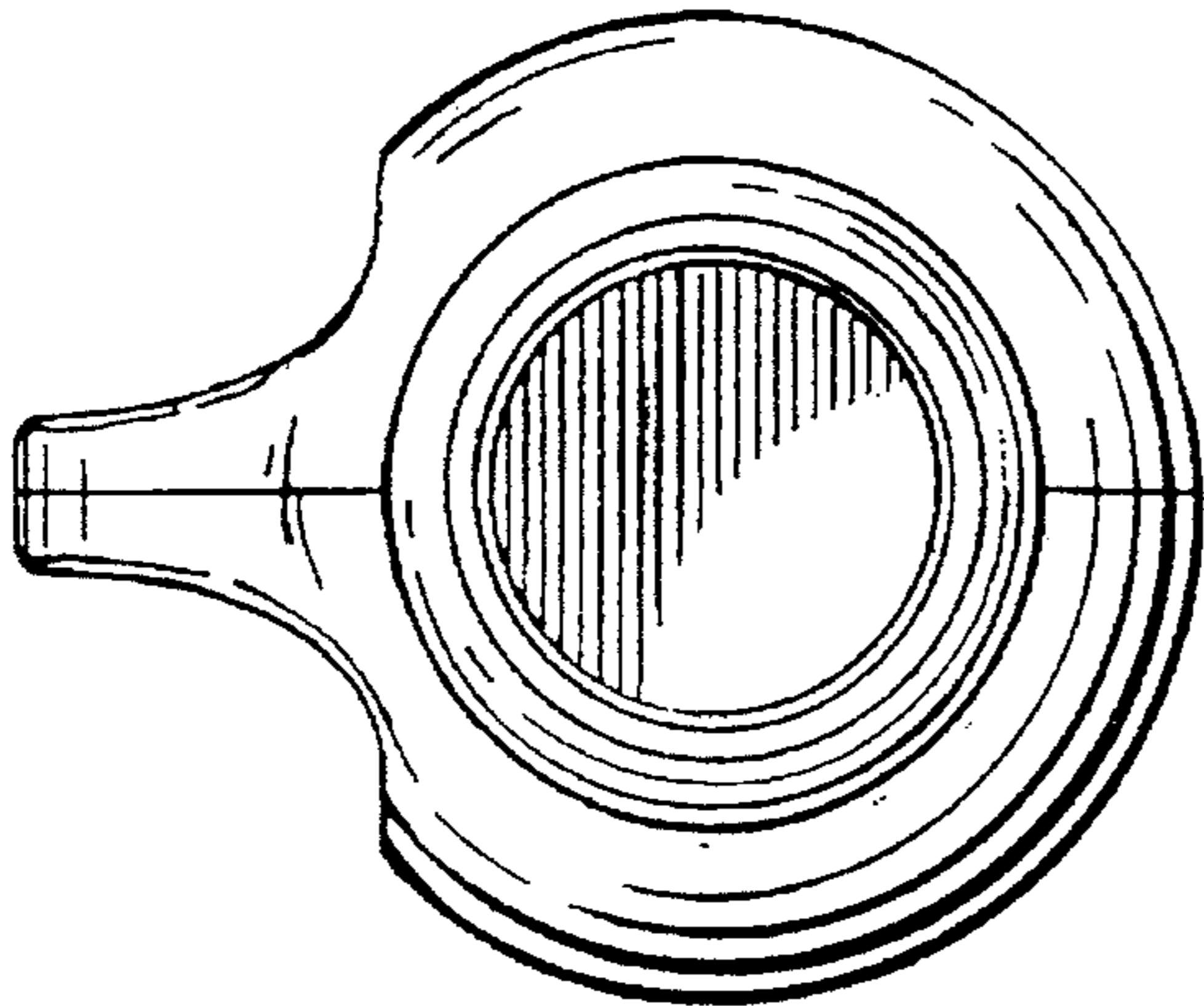

FIG. 4

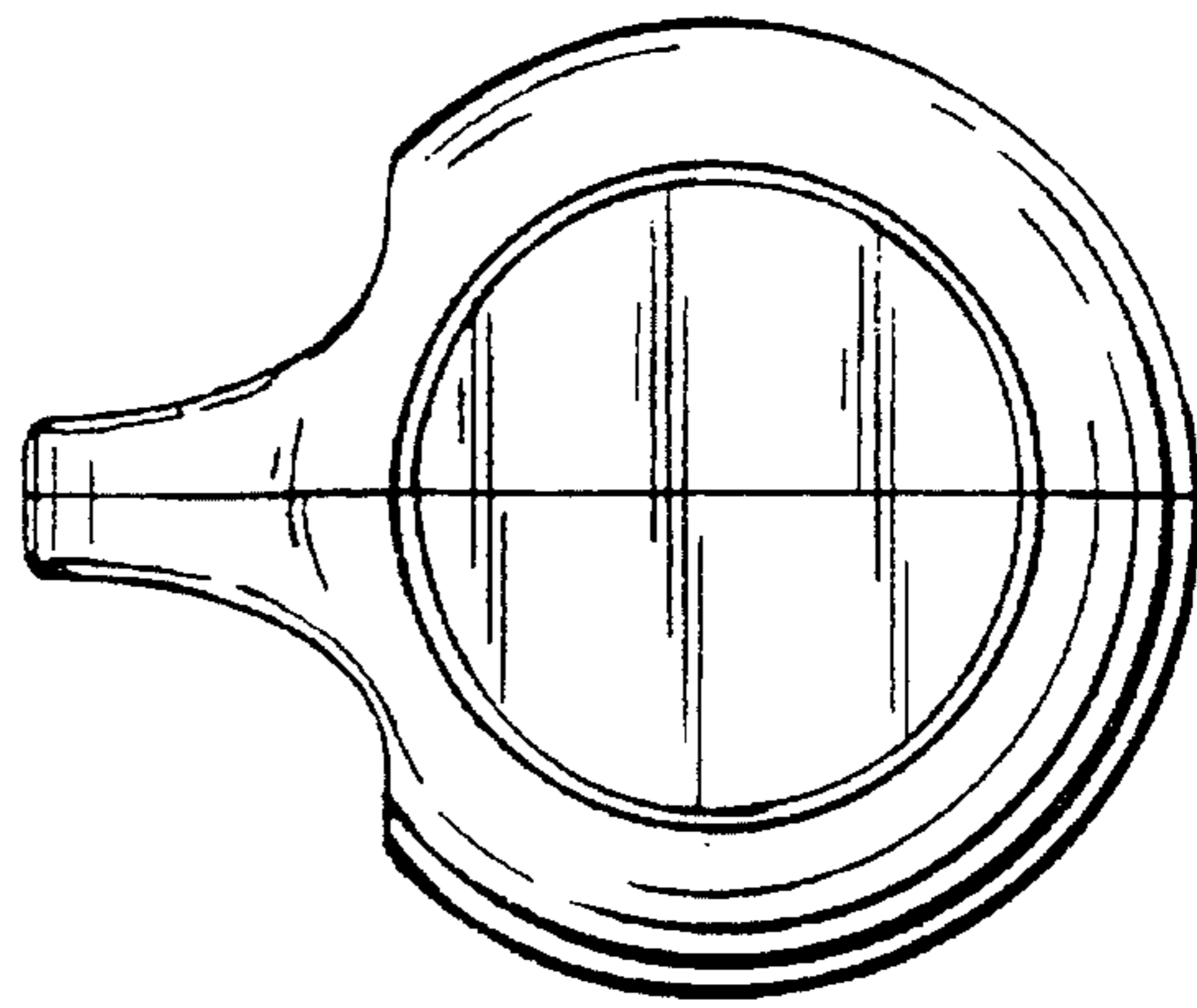

FIG. 5

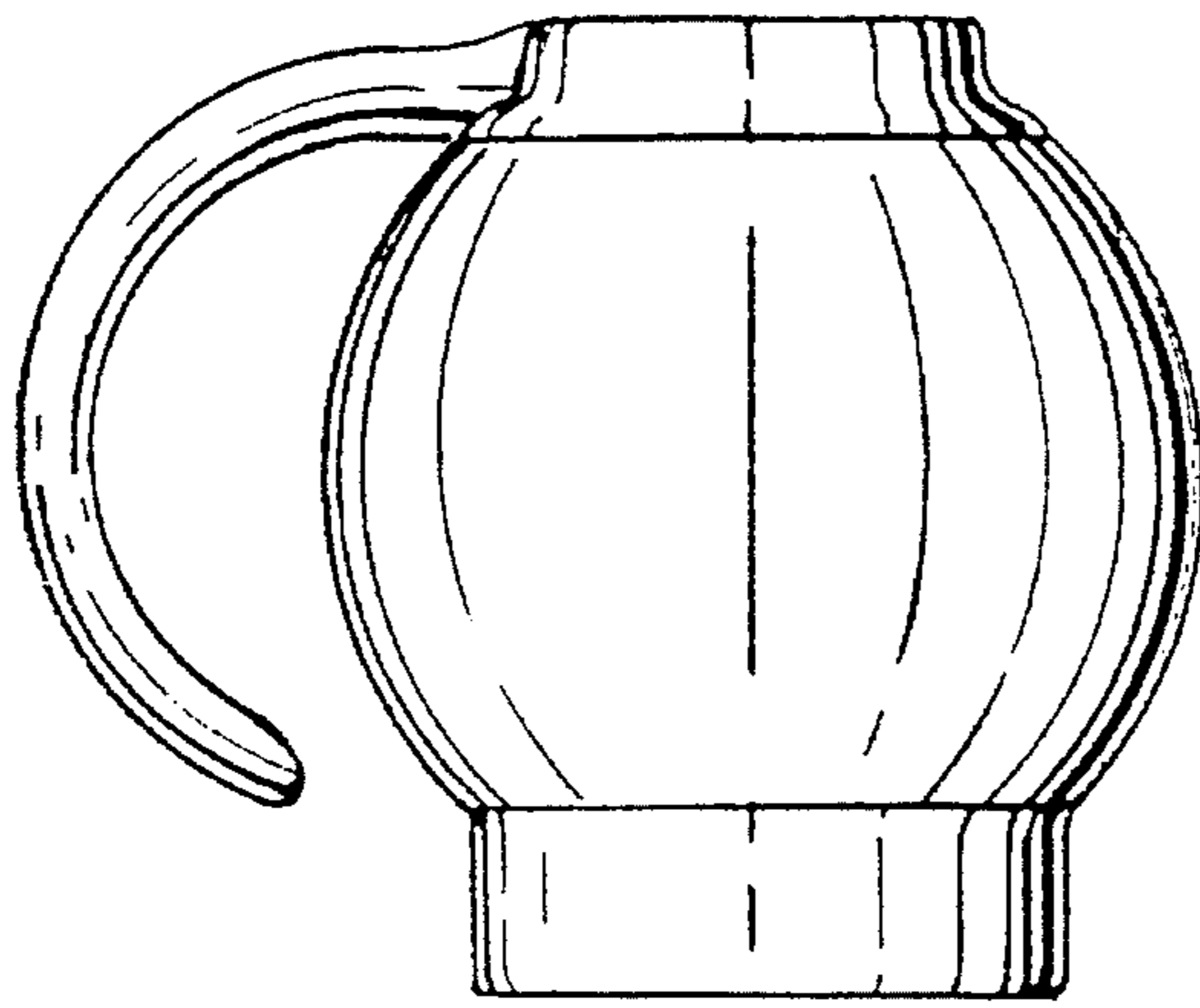

FIG. 6

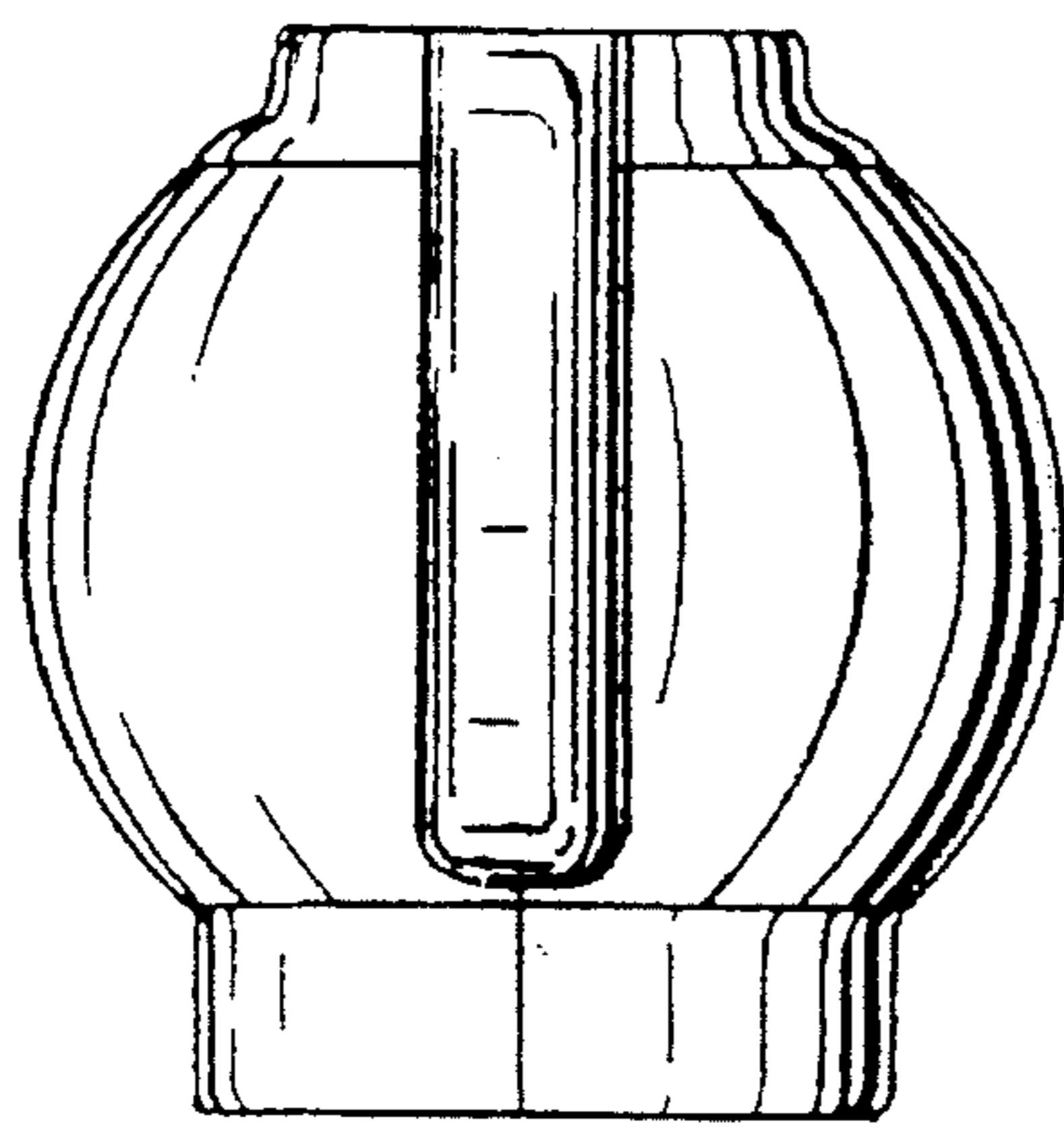

FIG. 7

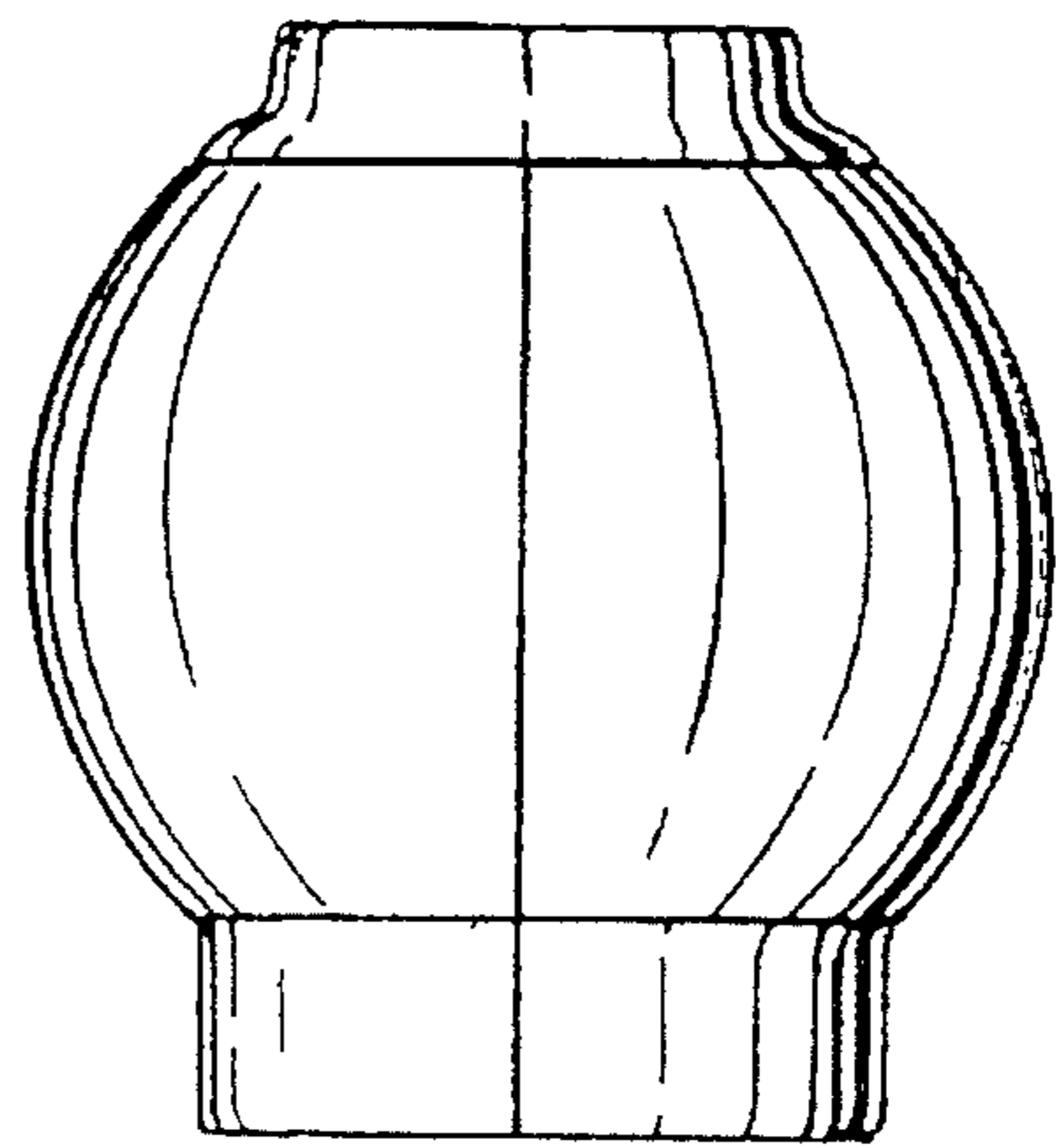

FIG. 8

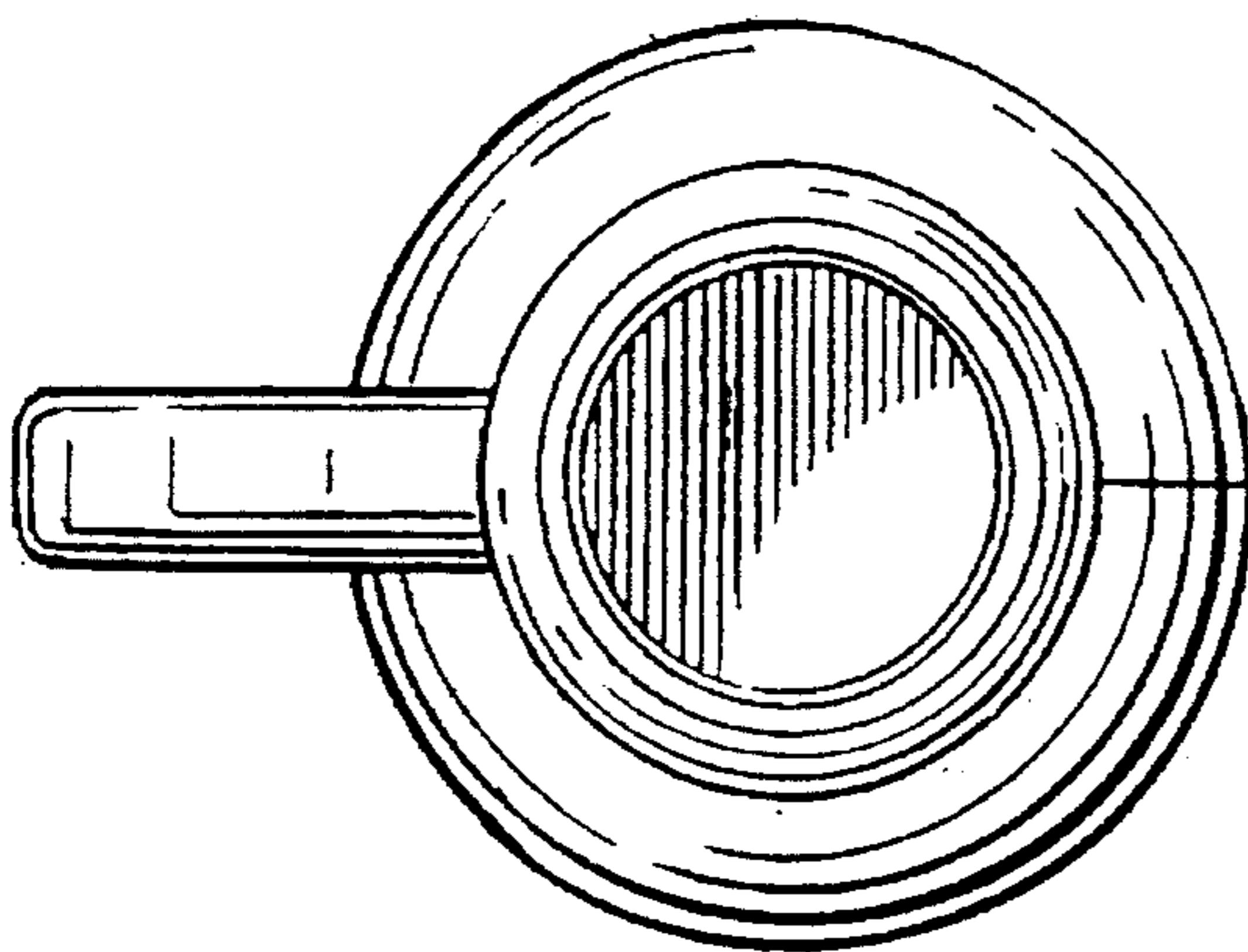

FIG. 9

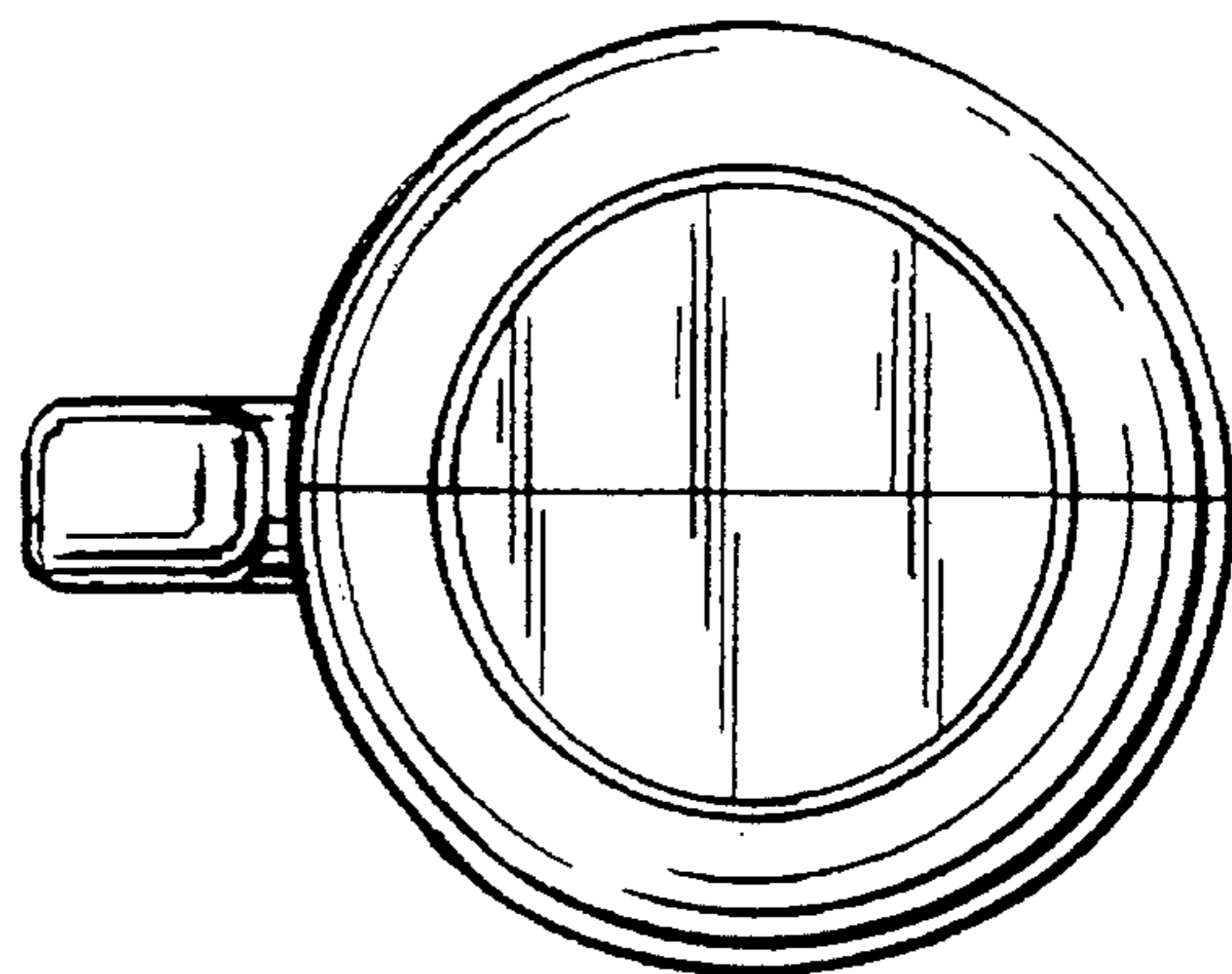

FIG. 10

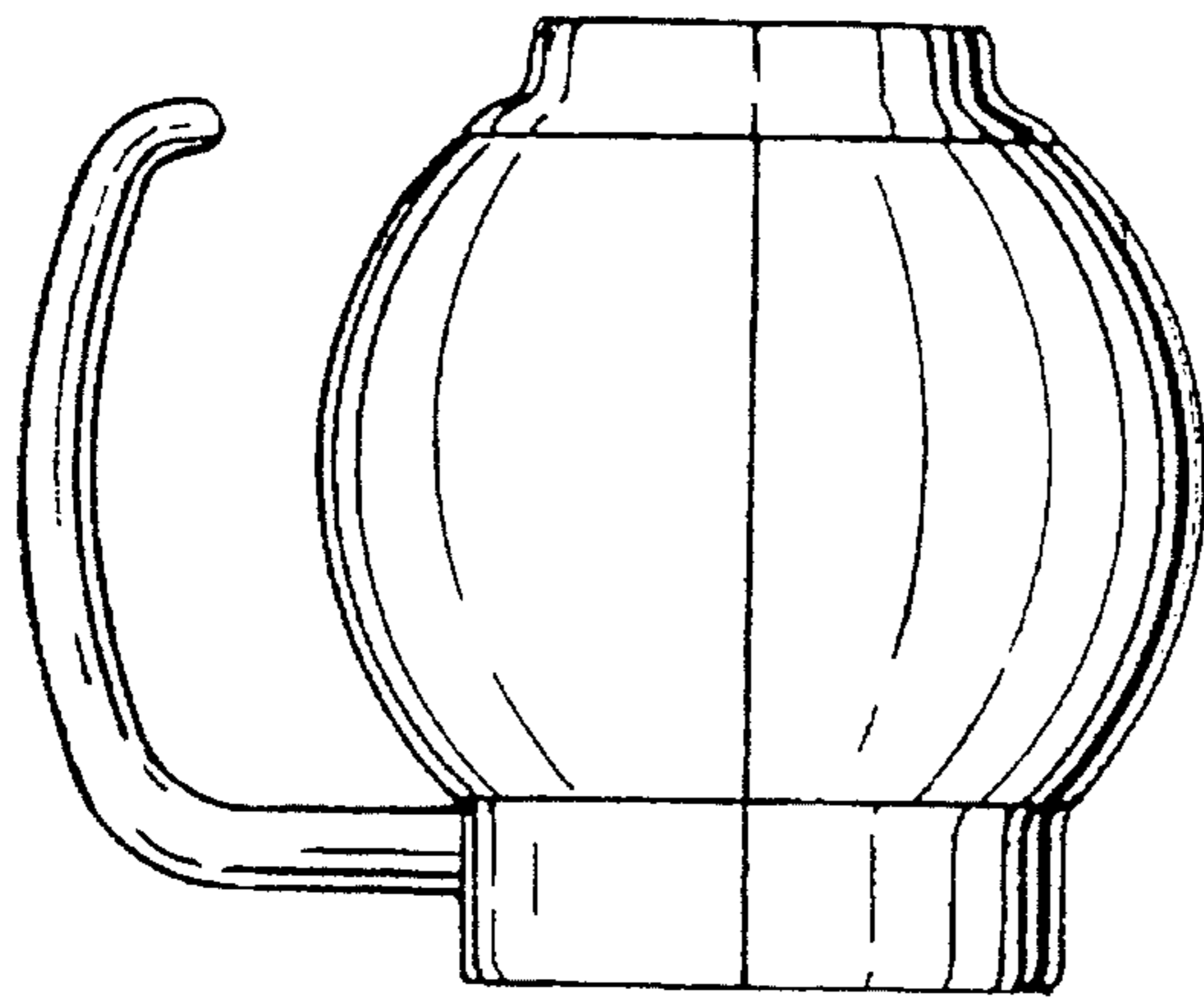

FIG. 11

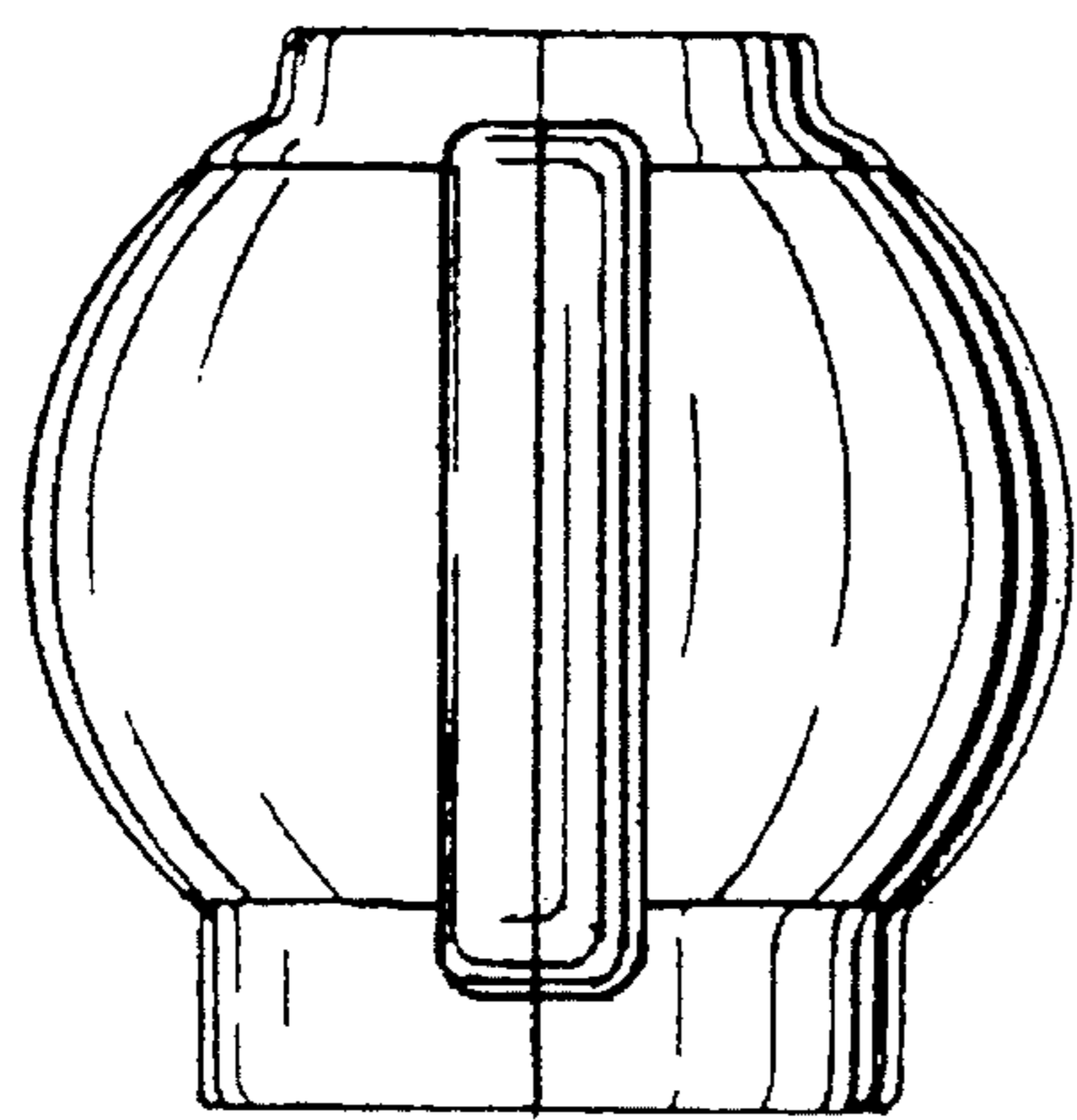

FIG. 12

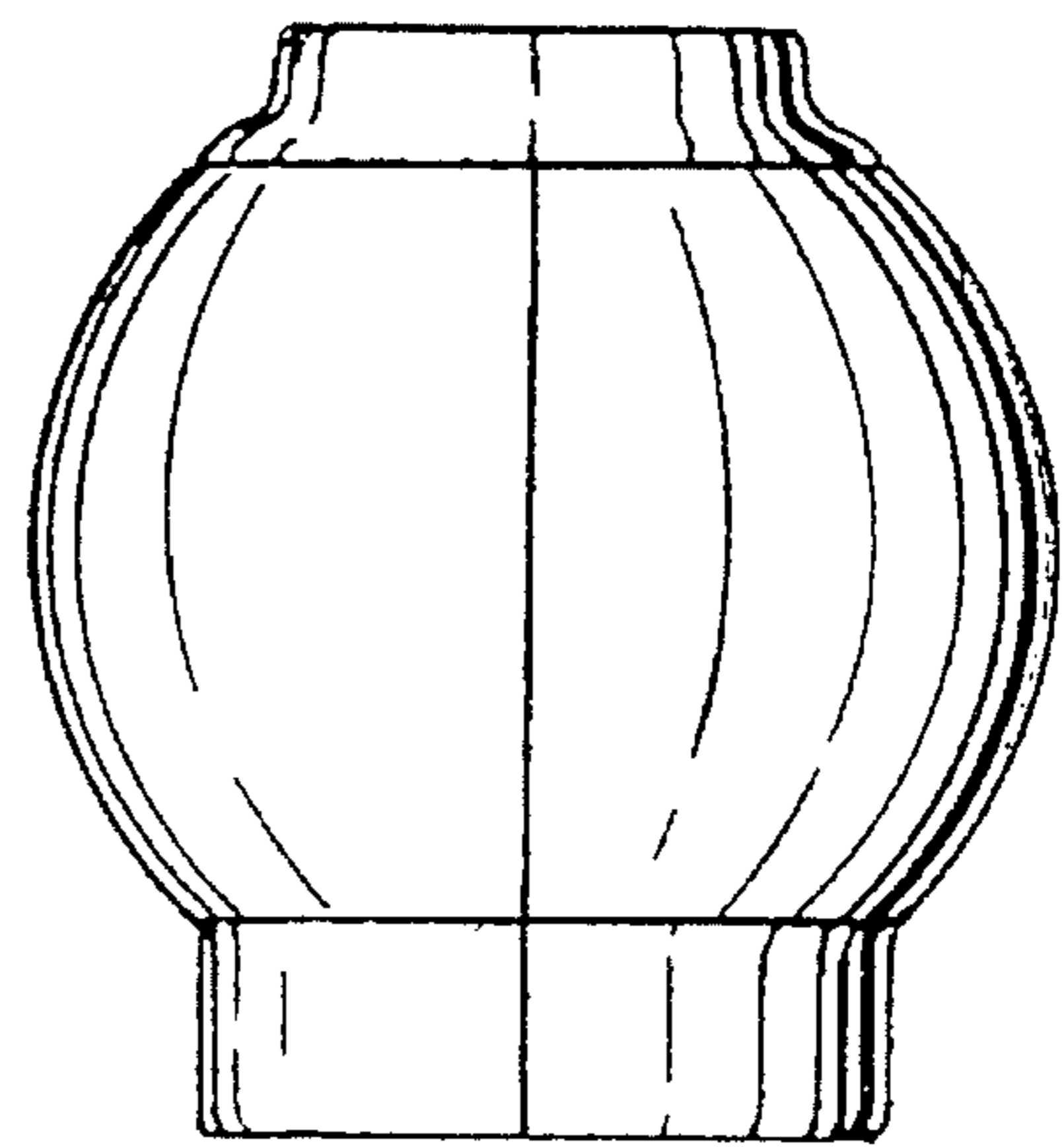

FIG. 13

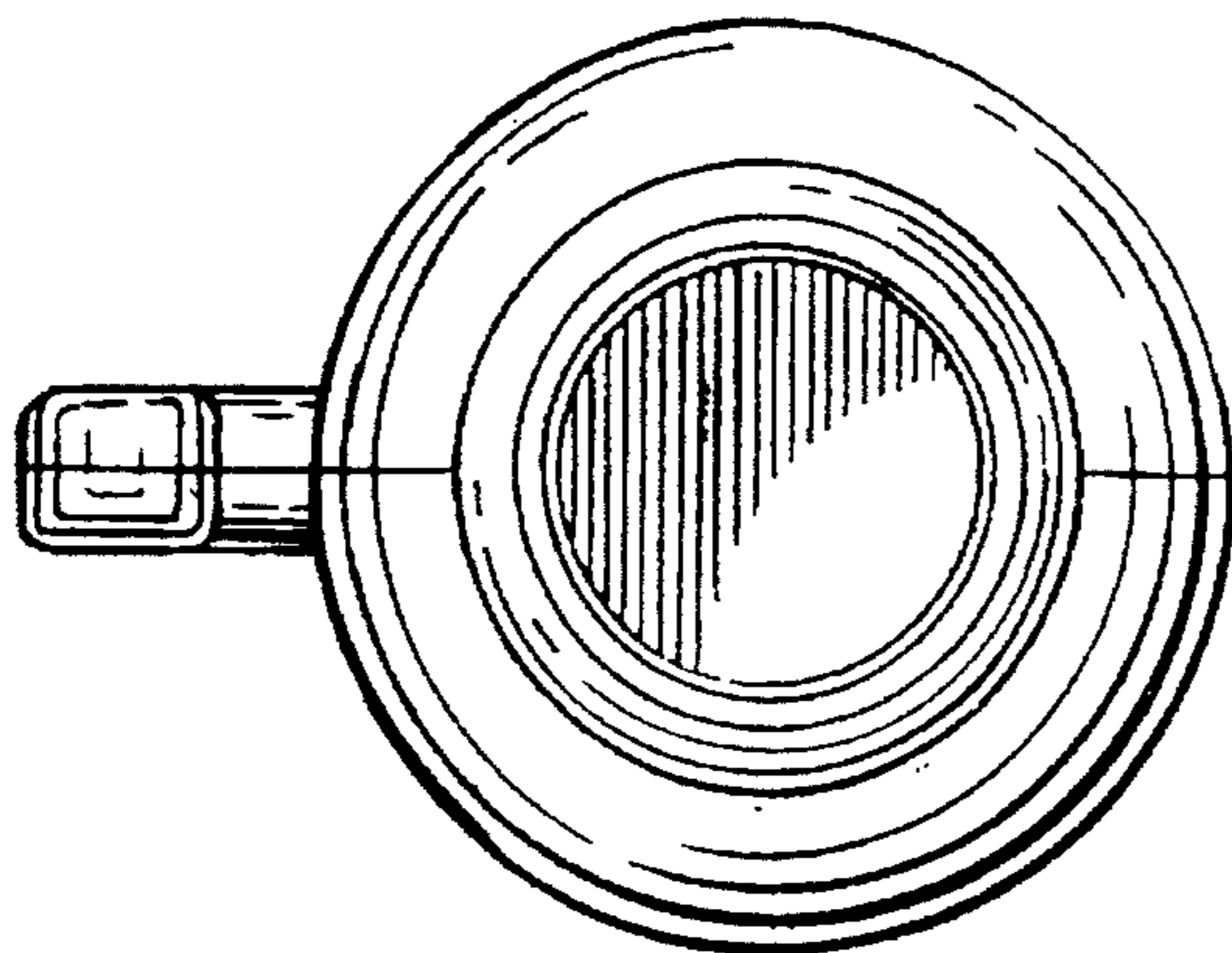

FIG. 14

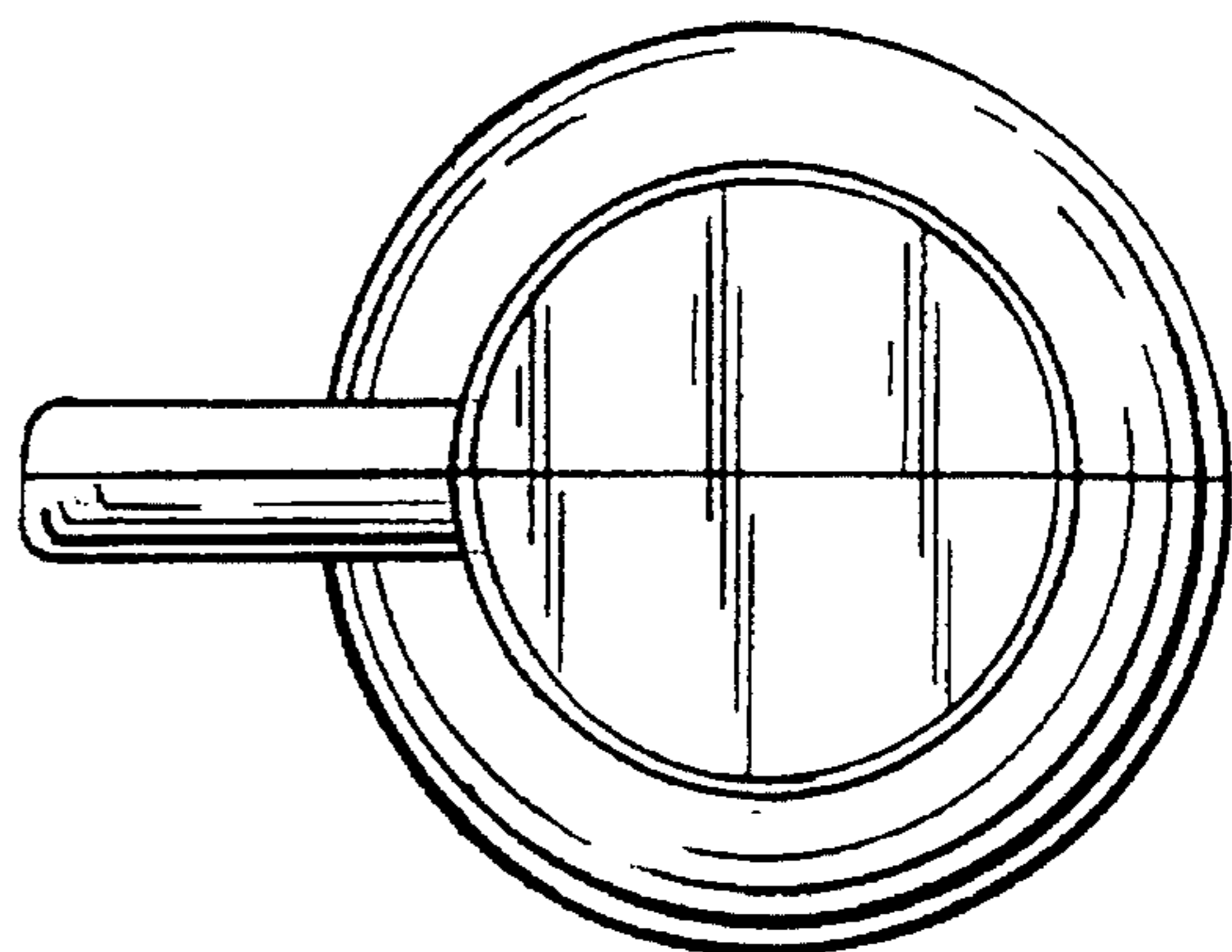

FIG. 15