



US00D364991S

United States Patent [19]

[11] Patent Number: **Des. 364,991**

Lee

[45] Date of Patent: ****Dec. 12, 1995**

[54] **KETTLE**

[75] Inventor: **Chen-Kun Lee**, Taichung Hsien, Taiwan

[73] Assignee: **Tou Tien Metal (Taiwan) Co., Ltd.**, Taichung Hsien, Taiwan

[**] Term: **14 Years**

[21] Appl. No.: **18,490**

[22] Filed: **Feb. 8, 1994**

[52] U.S. Cl. **D7/372**; D7/321

[58] Field of Search D7/300, 312, 316, D7/317, 318, 321, 322, 608; 222/465.1, 475.1; 366/314, 205

[56] **References Cited**

U.S. PATENT DOCUMENTS

D. 175,856	10/1955	Rowan	D7/319
D. 221,062	7/1971	Huthsing, Jr.	D7/312 X
D. 276,120	10/1984	Soloman	D7/312
D. 287,984	1/1987	Thomson et al.	D7/312 X
D. 288,518	3/1987	Lebowitz	D7/322
D. 288,890	3/1987	Lebowitz	D7/322
D. 296,068	6/1988	Yano	D7/322
D. 302,093	7/1989	Pacsby	D7/317
D. 308,315	6/1990	Ancona et al.	D7/312
D. 308,797	6/1990	Ancona et al.	D7/322
D. 311,110	10/1990	Hess	D7/321 X

D. 322,734	12/1991	Soloman	D7/312 X
D. 336,006	6/1993	Lebowitz	D7/312 X
1,388,958	8/1921	Lafond	222/465.1
3,591,060	7/1971	Nakamura	D7/312

FOREIGN PATENT DOCUMENTS

49803	3/1993	Japan	222/475.1
-------	--------	-------	-------	-----------

OTHER PUBLICATIONS

Whistling Tea Kettle, The Enterprise Aluminum Company HF R 1938.

Tea Pot, HFD p 70 (Feb. 8, 1988).

Primary Examiner—Alan P. Douglas

Assistant Examiner—M. N. Pandozzi

Attorney, Agent, or Firm—Rogers, Howell & Haferkamp

[57] **CLAIM**

The ornamental design for a kettle, as shown and described.

DESCRIPTION

FIG. 1 is a front-right-top perspective view of a kettle, showing my new design;

FIG. 2 is a front elevational view thereof (the rear elevational view being a mirror image thereof);

FIG. 3 is a left side elevational view thereof;

FIG. 4 is a right side elevational view thereof;

FIG. 5 is a top plan view thereof; and,

FIG. 6 is a bottom plan view thereof.

1 Claim, 3 Drawing Sheets

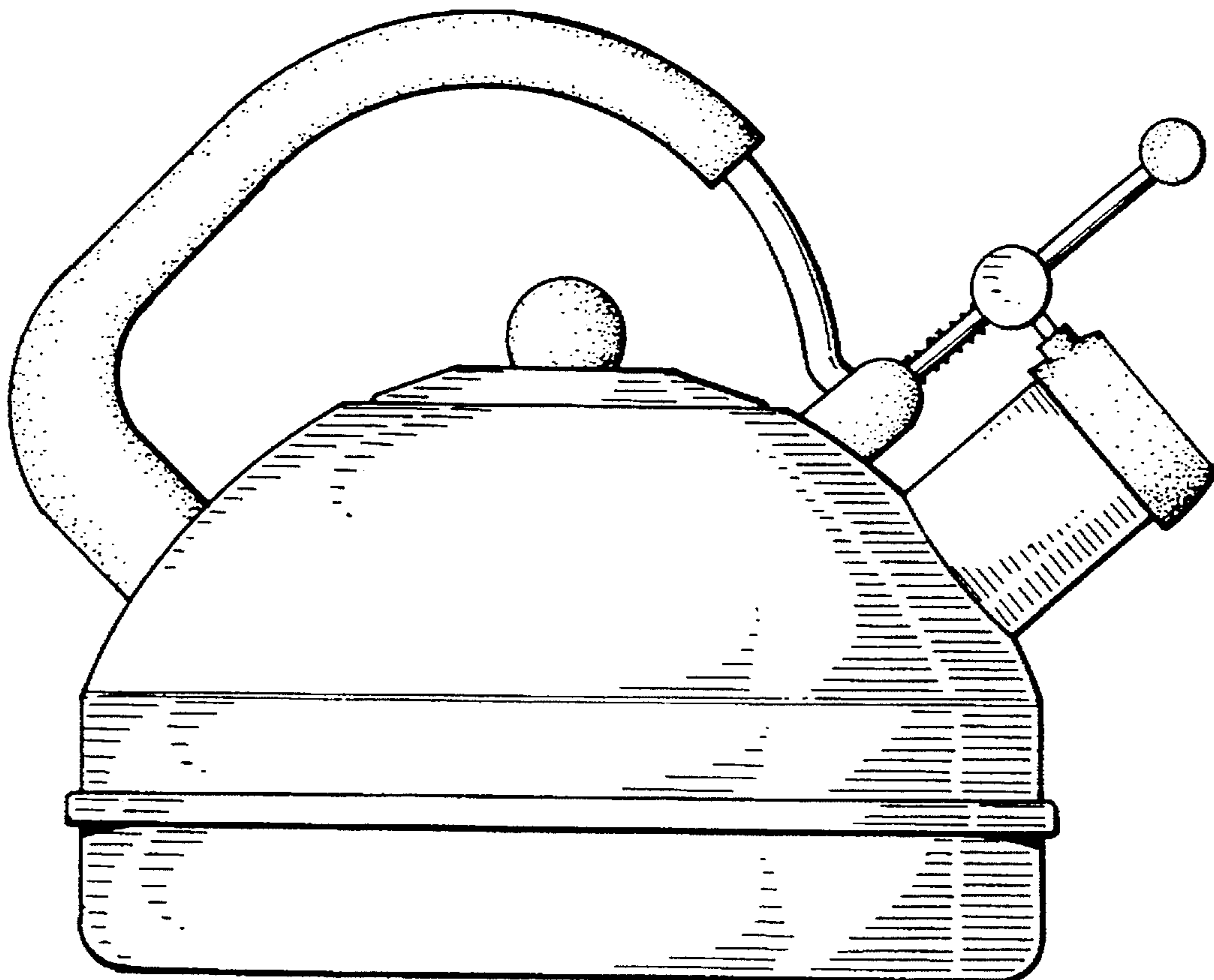

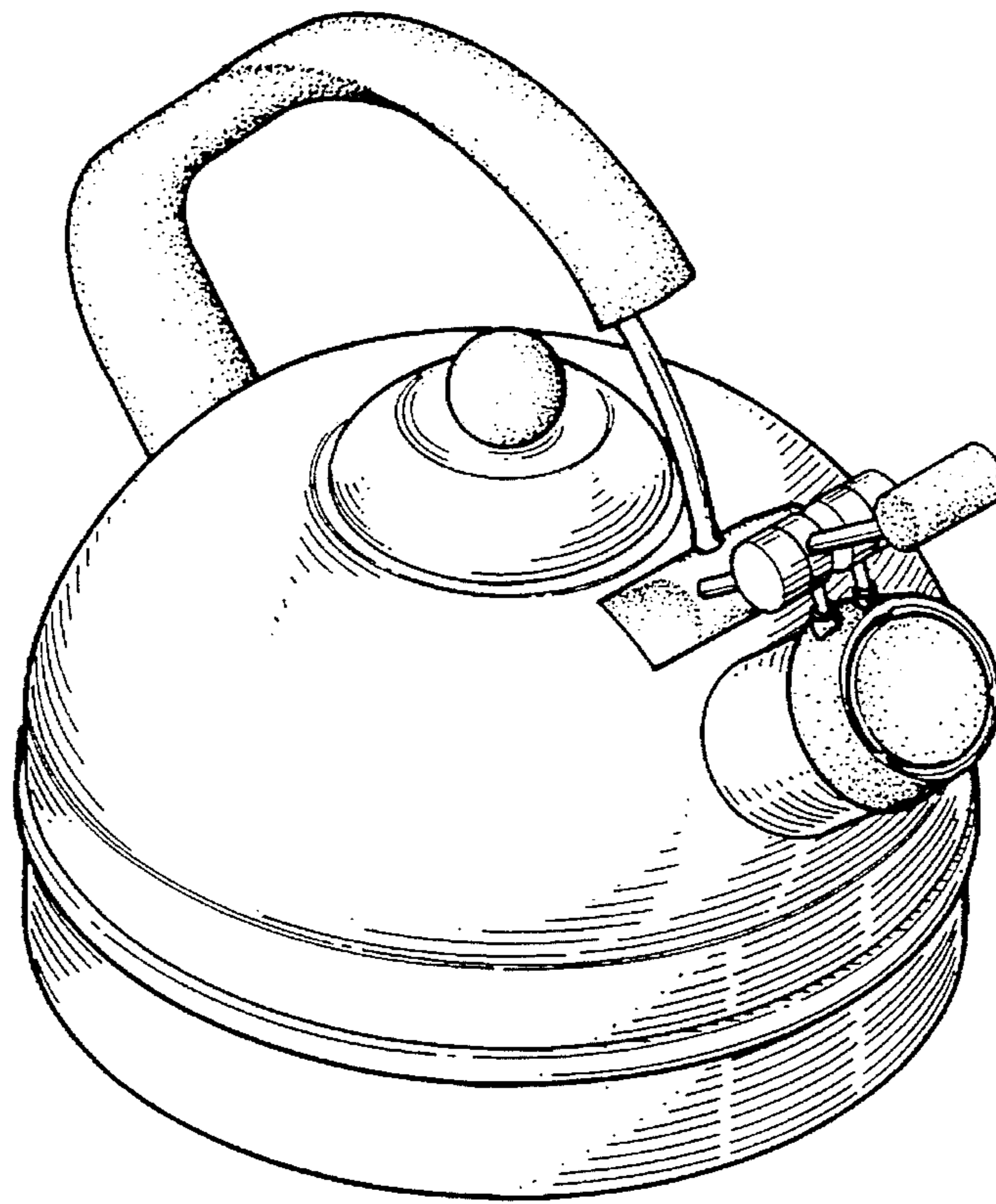

FIG. 1

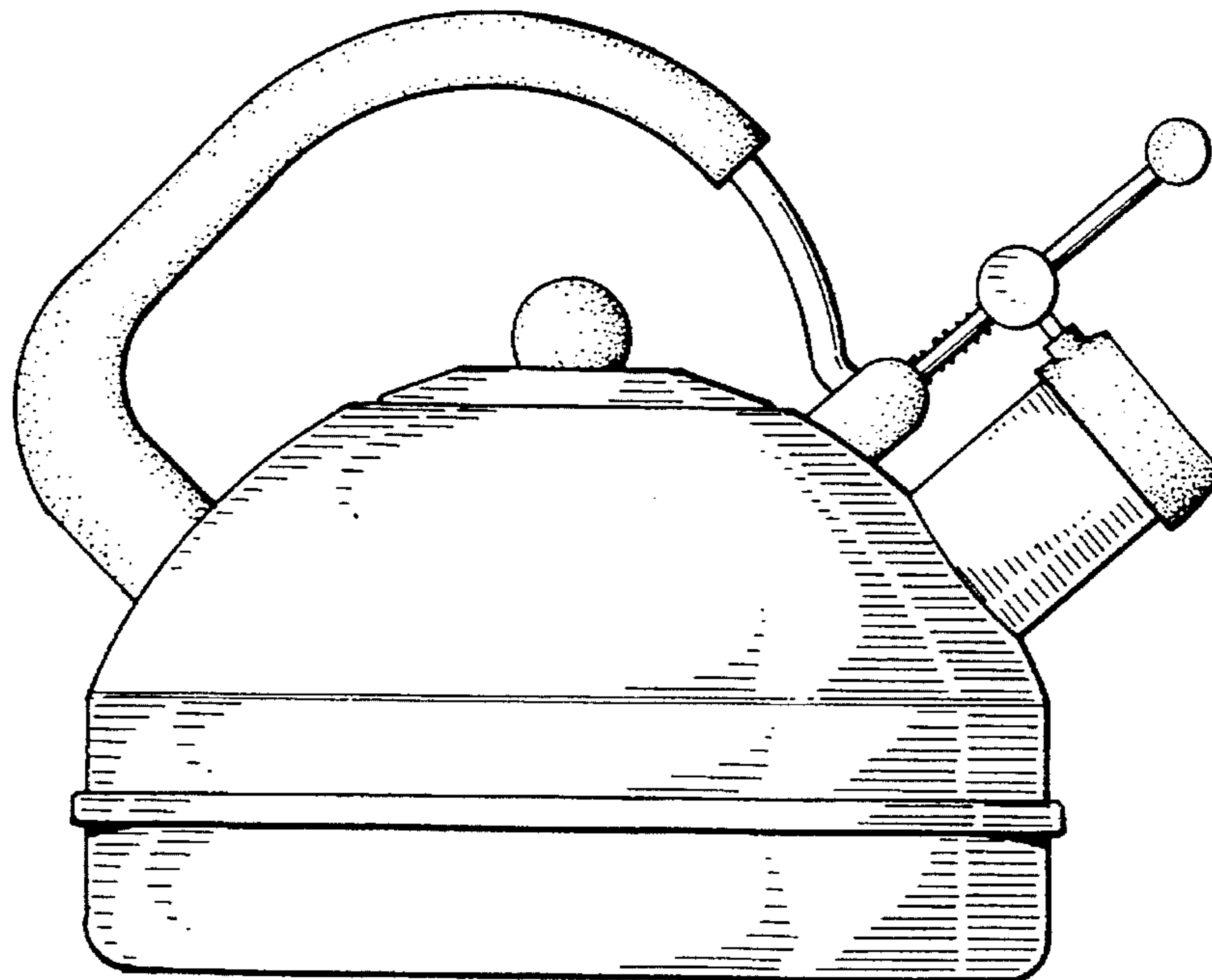

FIG. 2

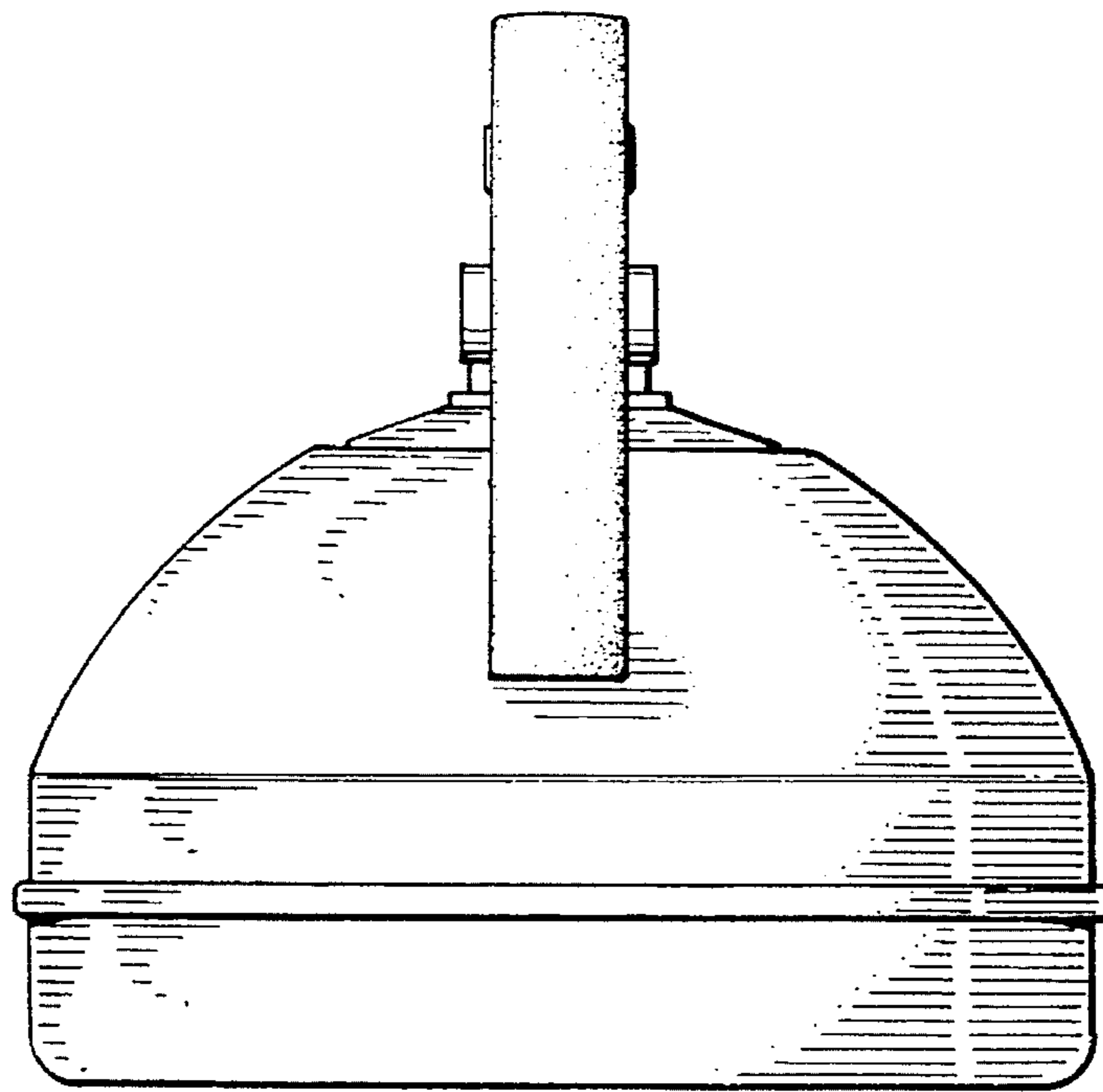

FIG. 3

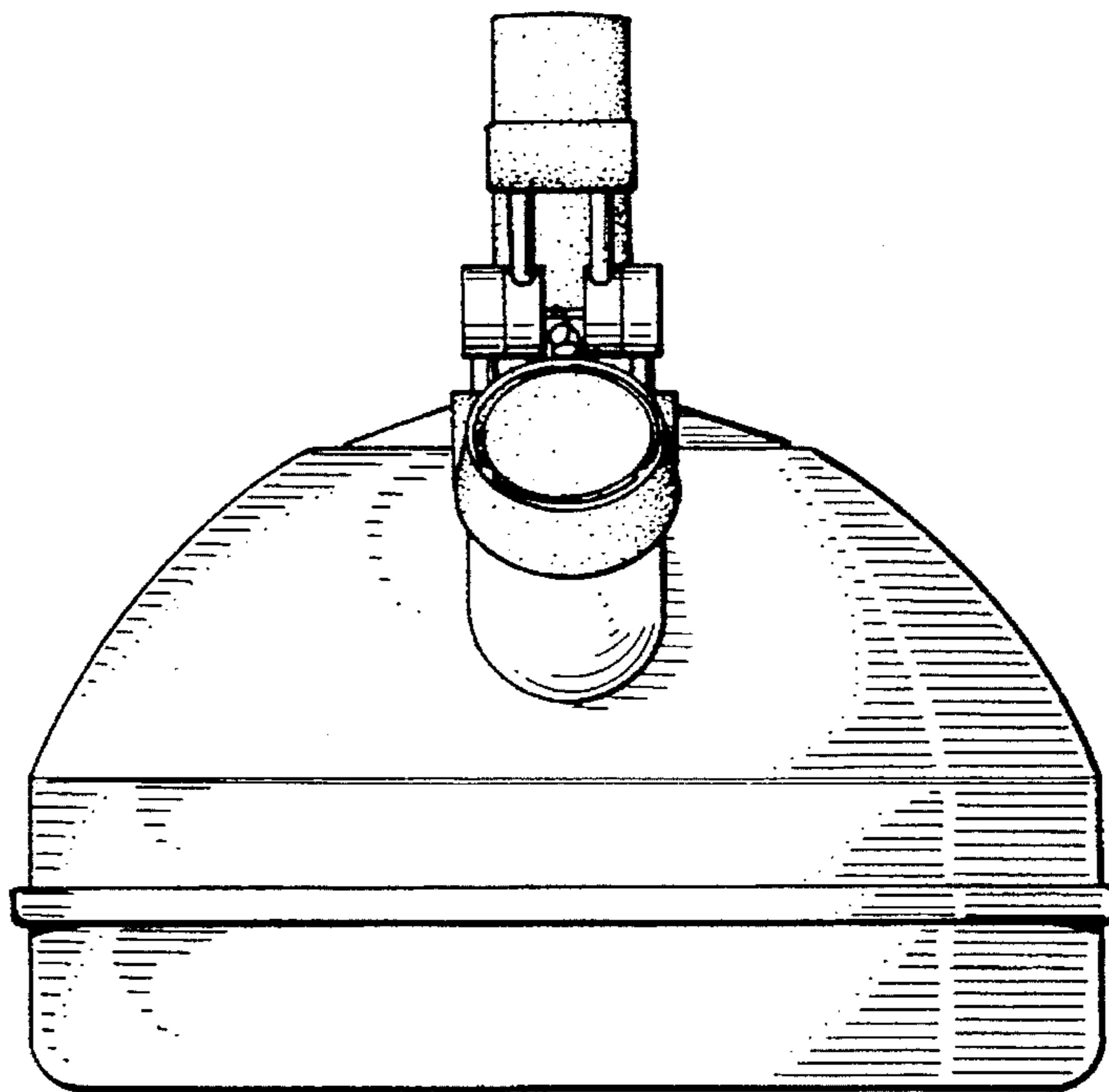

FIG. 4

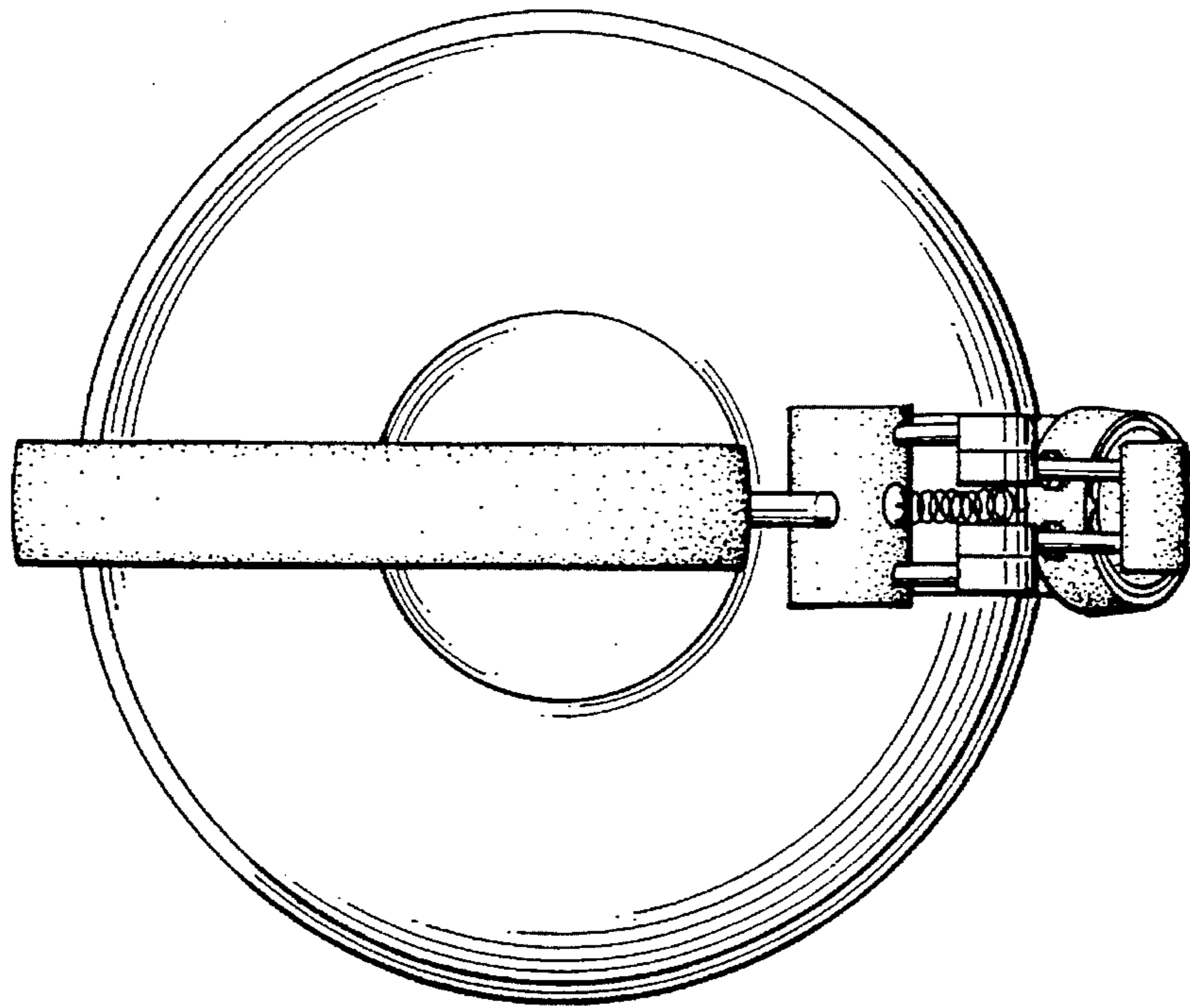

FIG. 5

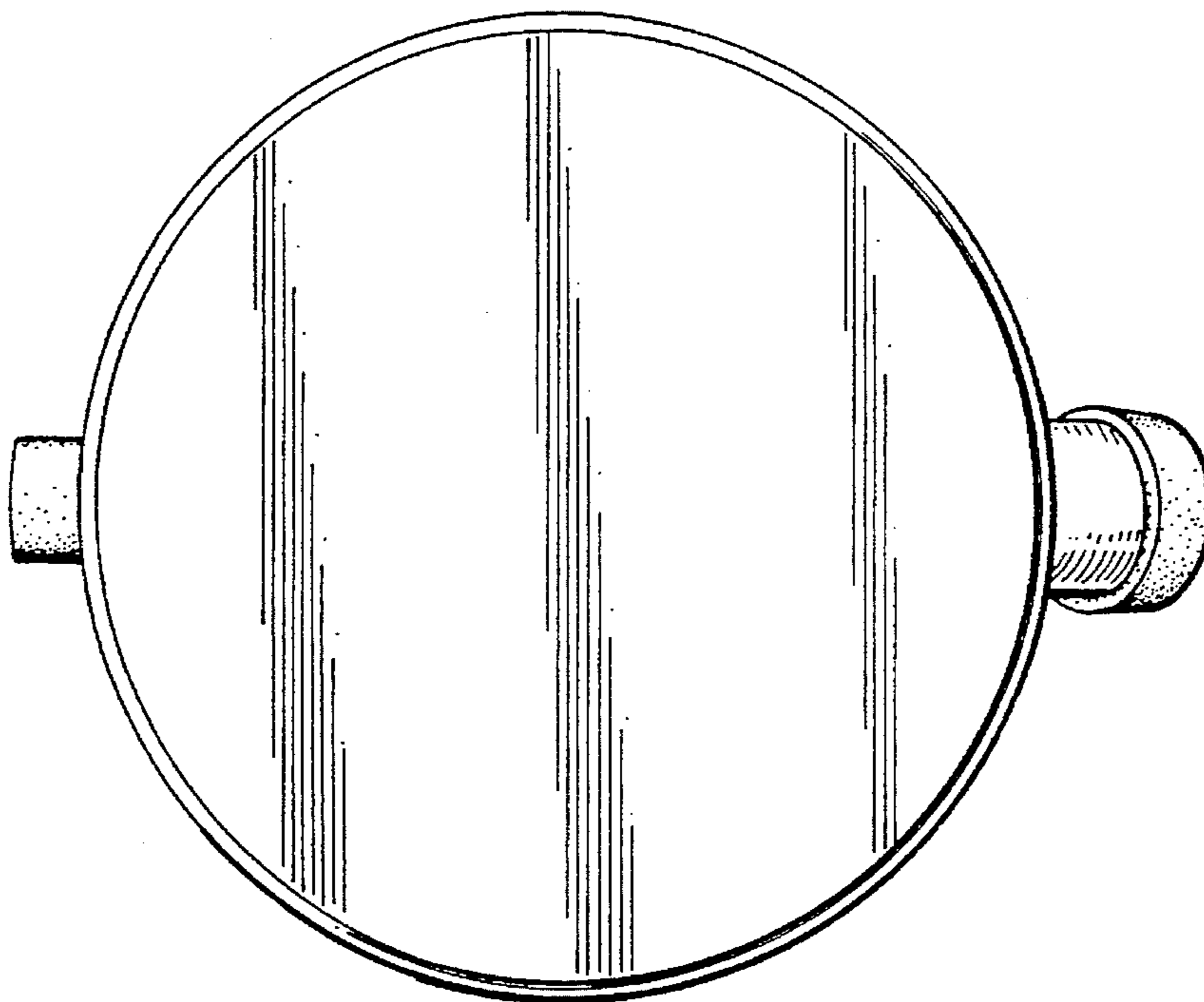

FIG. 6