



US00D364889S

United States Patent [19]

[11] Patent Number: **Des. 364,889**

Ishiura

[45] Date of Patent: ***** Dec. 5, 1995**

[54] **WORD PROCESSOR**

[75] Inventor: **Ryoichi Ishiura**, Matsudo, Japan

[73] Assignee: **Kabushiki Kaisha Toshiba**, Kawasaki, Japan

[*] Notice: The portion of the term of this patent subsequent to Oct. 4, 2008, has been disclaimed.

[**] Term: **14 Years**

[21] Appl. No.: **5,477**

[22] Filed: **Feb. 25, 1993**

[30] **Foreign Application Priority Data**

Aug. 31, 1992 [JP] Japan 4-25447

[52] U.S. Cl. **D18/1; D14/106**

[58] **Field of Search** D18/1, 2, 7, 11, D18/12; D14/100, 101, 105, 106; 340/700, 706, 711, 712; 341/22, 23; 235/145 A, 145 R; 400/493.1, 494, 472, 473, 485; 364/706-709.9, 900

[56] **References Cited**

U.S. PATENT DOCUMENTS

- D. 289,177 4/1987 Sawada D18/7
- D. 302,267 7/1989 Genaro et al. .
- D. 310,235 8/1990 Sakaguchi et al. D18/1

- D. 312,075 11/1990 Lam D14/106
- D. 312,451 11/1990 Katoh et al. D18/1 X
- D. 316,706 5/1991 Imamura et al. D14/106
- D. 323,157 1/1992 Mia .
- D. 351,183 10/1994 Ishiura D18/1

Primary Examiner—Alan P. Douglas
Assistant Examiner—Caron D. Veynar
Attorney, Agent, or Firm—Oblon, Spivak, McClelland, Maier & Neustadt

[57] **CLAIM**

The ornamental design for a word processor, as shown and described.

DESCRIPTION

FIG. 1 is a top, front and right side perspective view of a word processor, showing my new design;
FIG. 2 is a front elevational view thereof;
FIG. 3 is a right side elevational view thereof;
FIG. 4 is a left side elevational view thereof;
FIG. 5 is a top plan view thereof;
FIG. 6 is a rear elevational view thereof;
FIG. 7 is a bottom plan view thereof;
FIG. 8 is a front elevational view thereof with an upper unit closed in a storage position;
FIG. 9 is a right side elevational view thereof with the upper unit closed in a storage position; and,
FIG. 10 is a top plan view thereof with the upper unit closed in a storage position.

1 Claim, 4 Drawing Sheets



FIG. 1

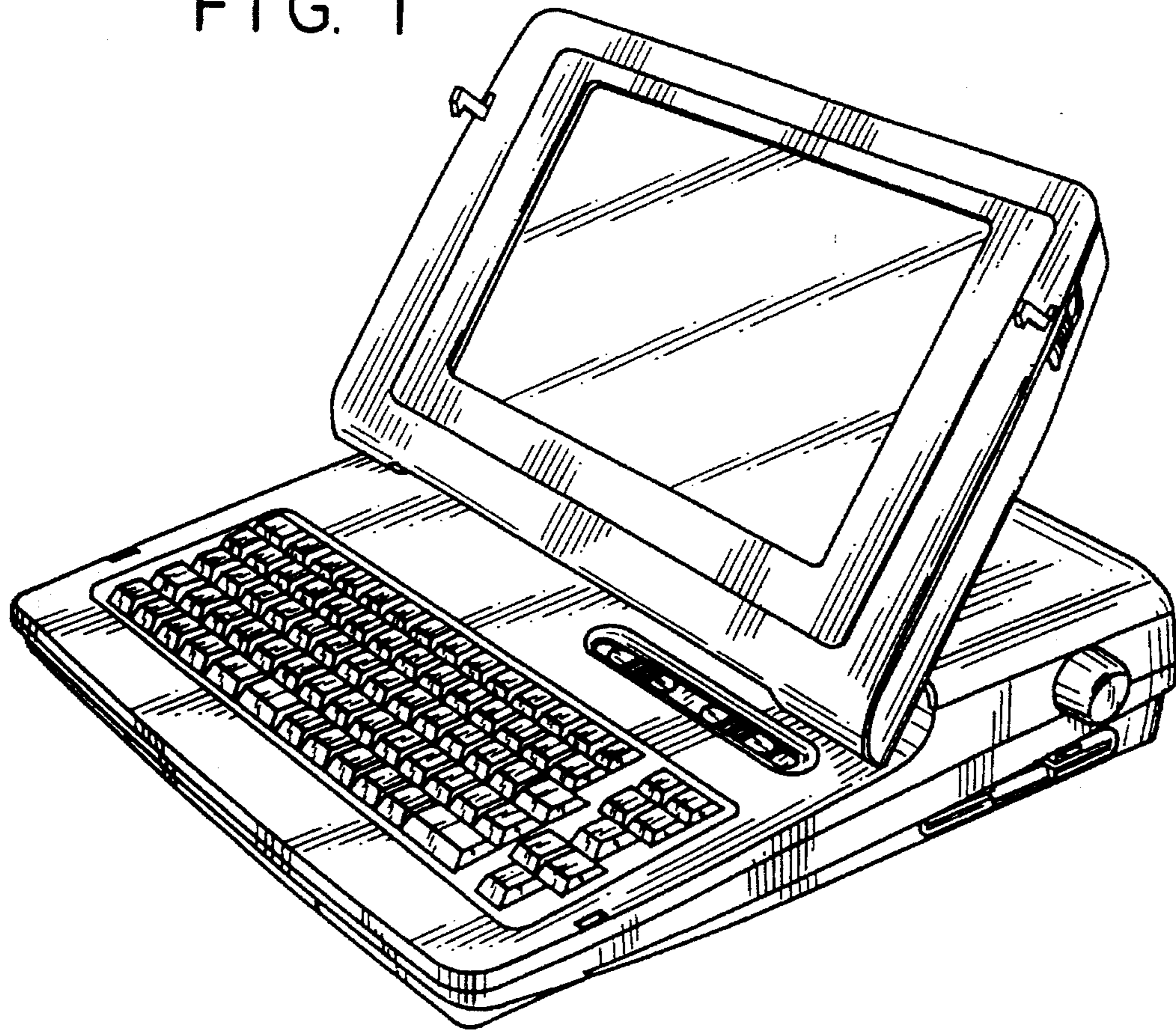

FIG. 2

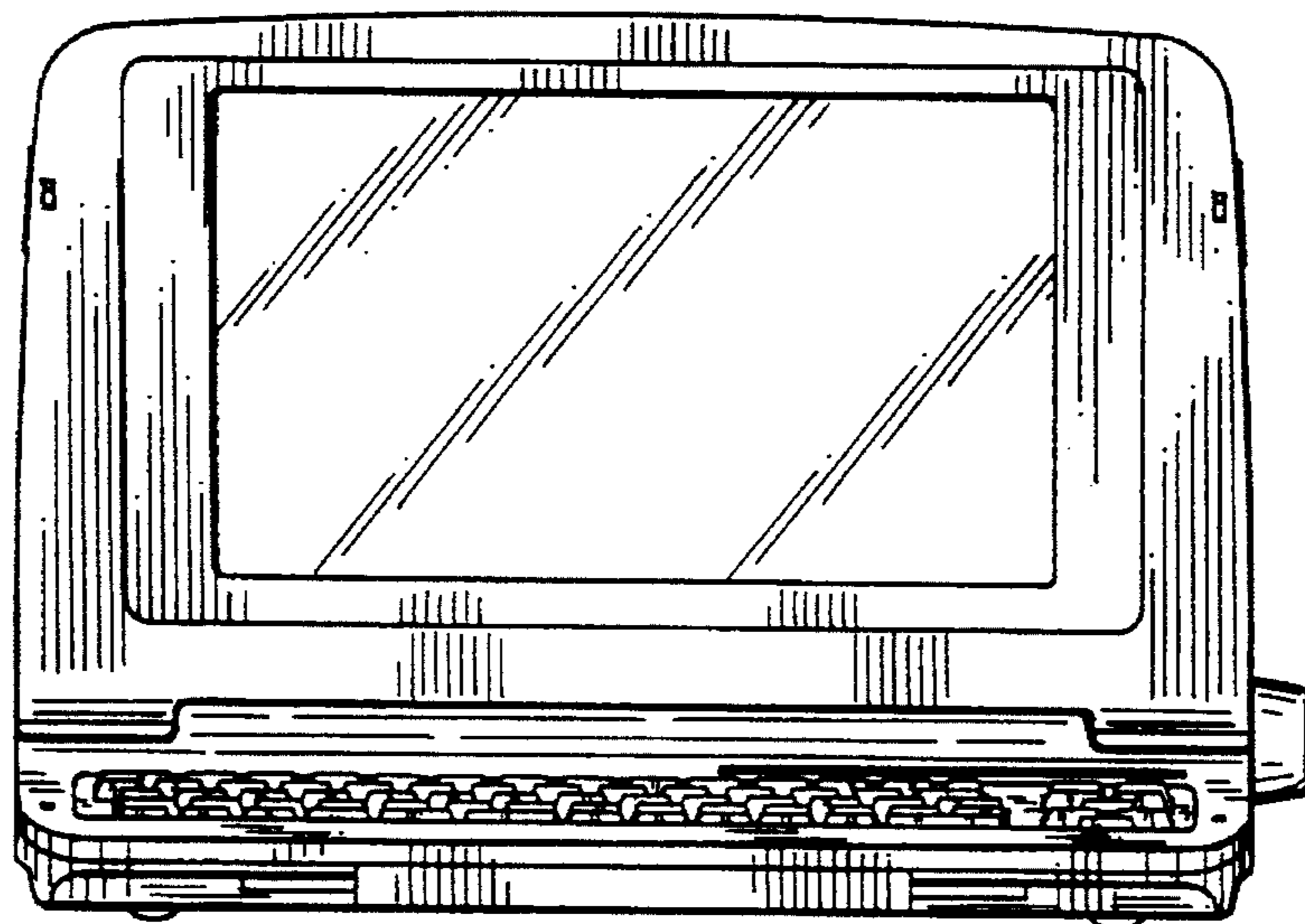

FIG. 3

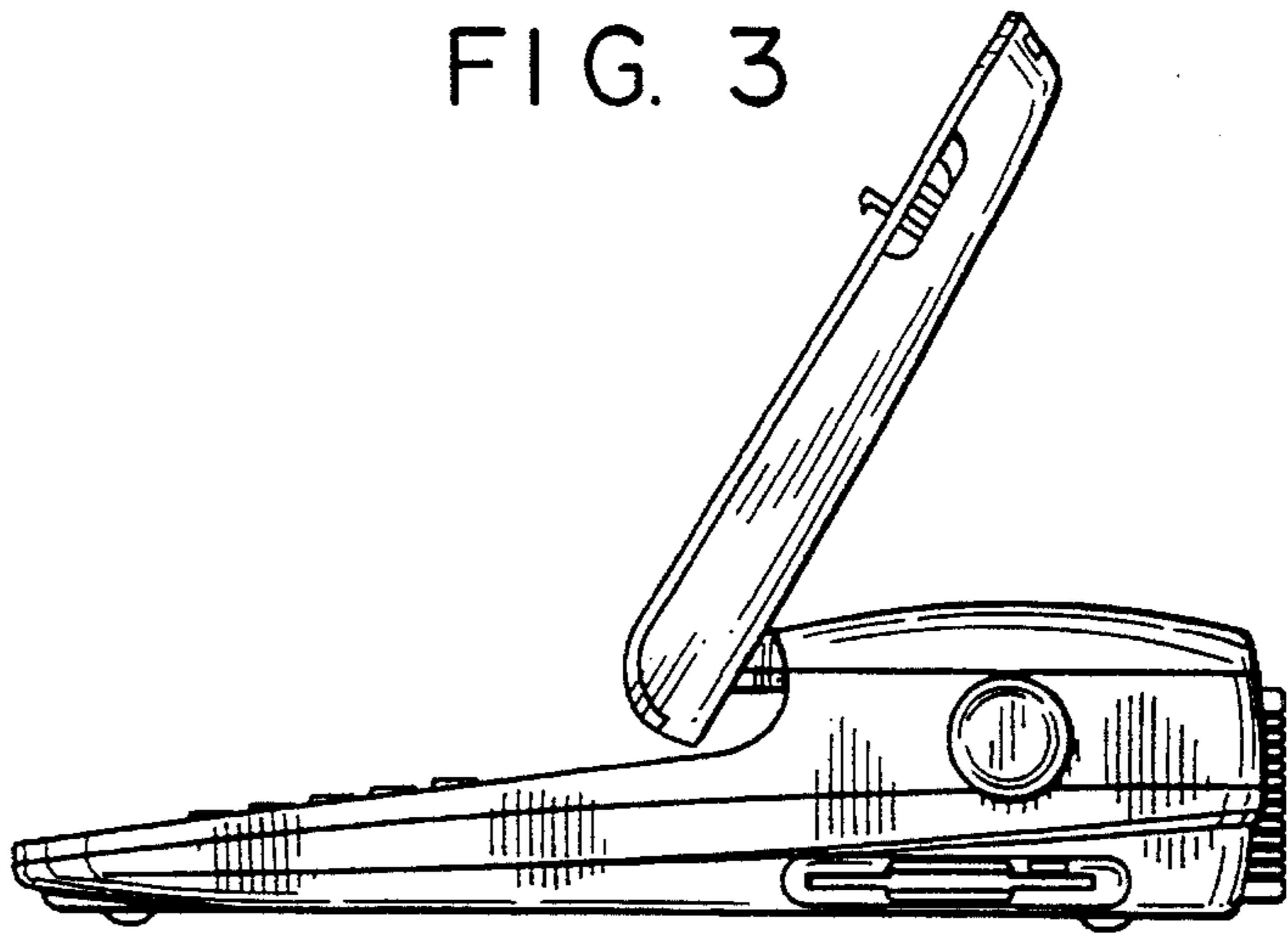

FIG. 4

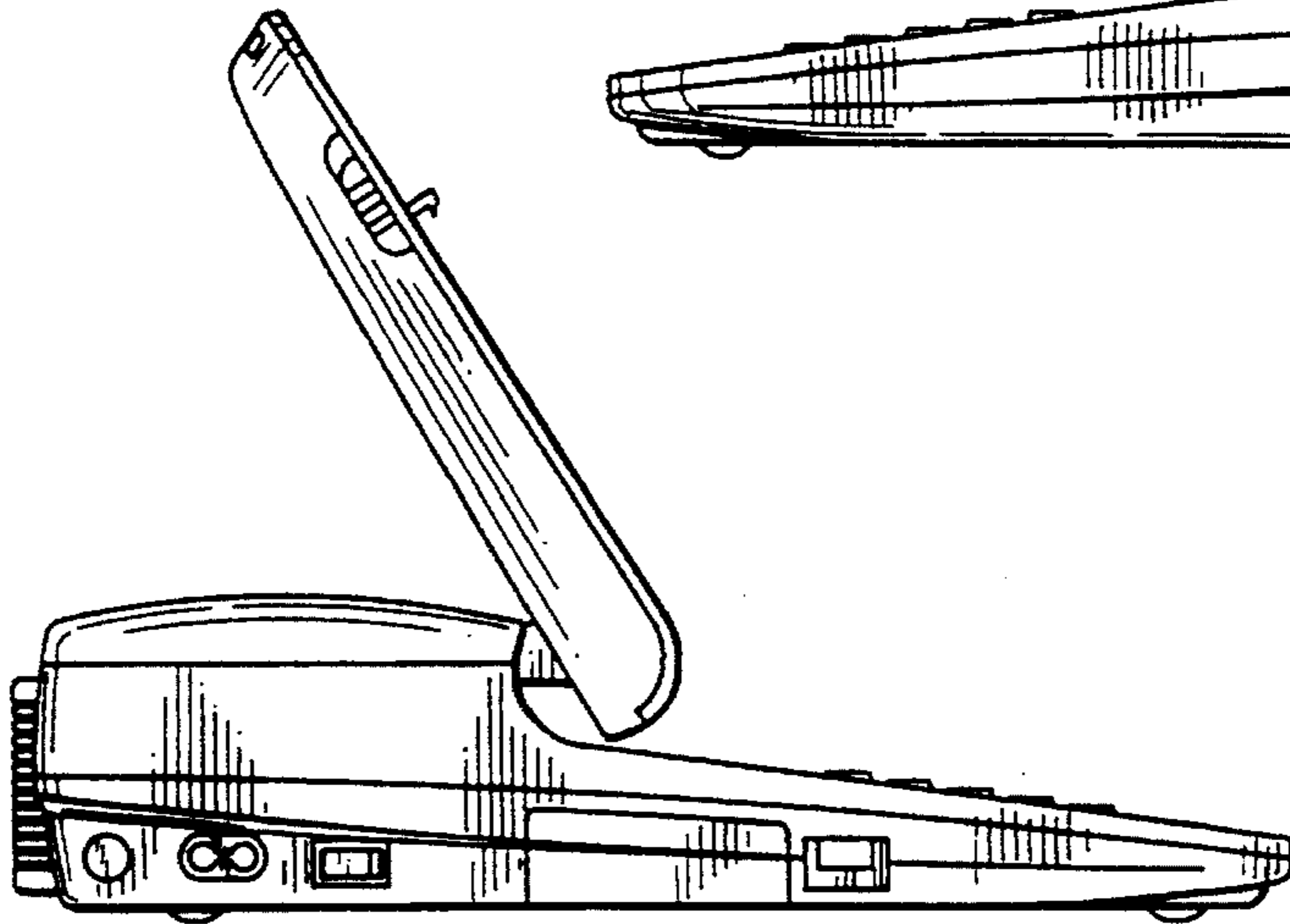

FIG. 5

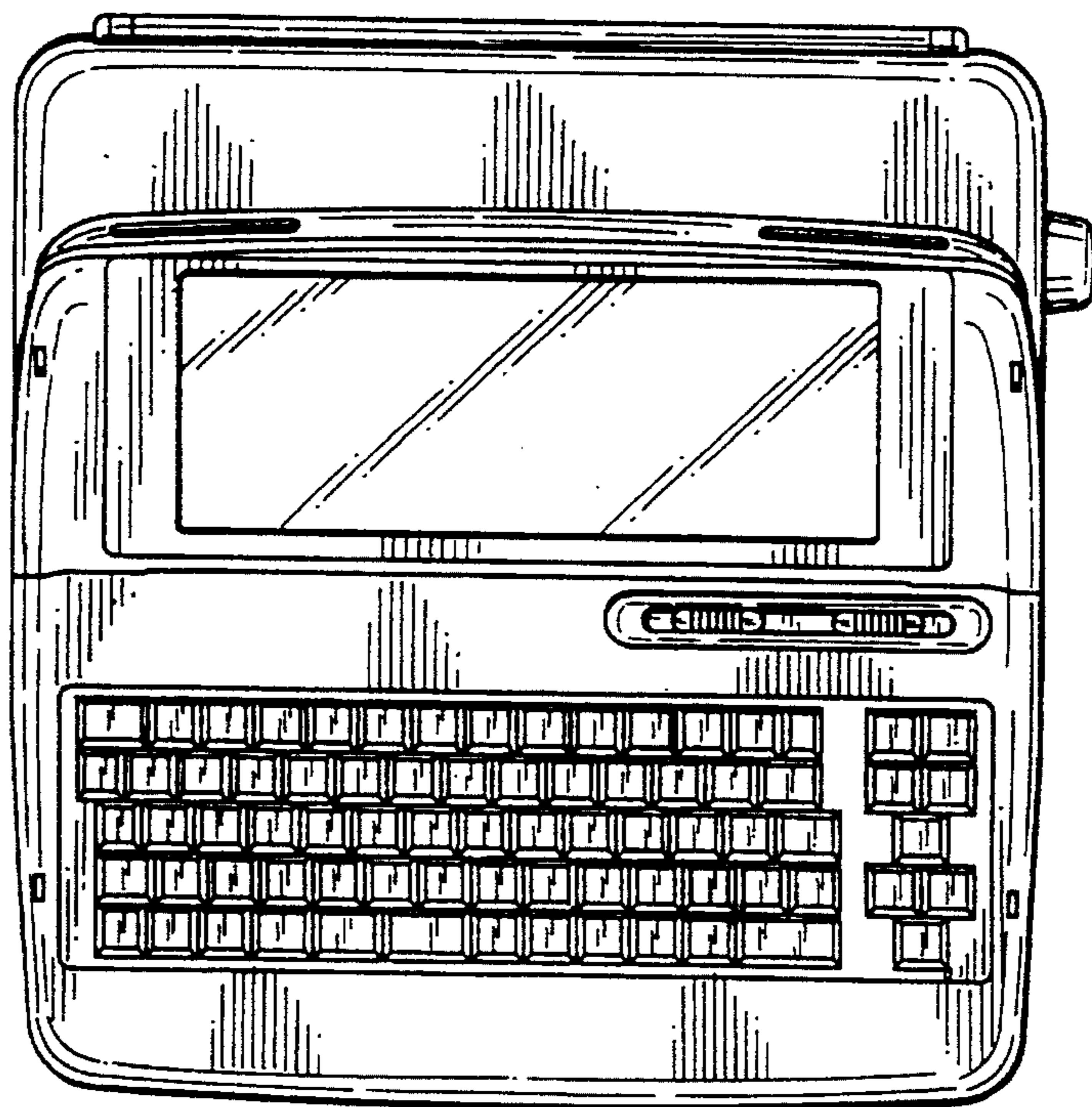

FIG. 6

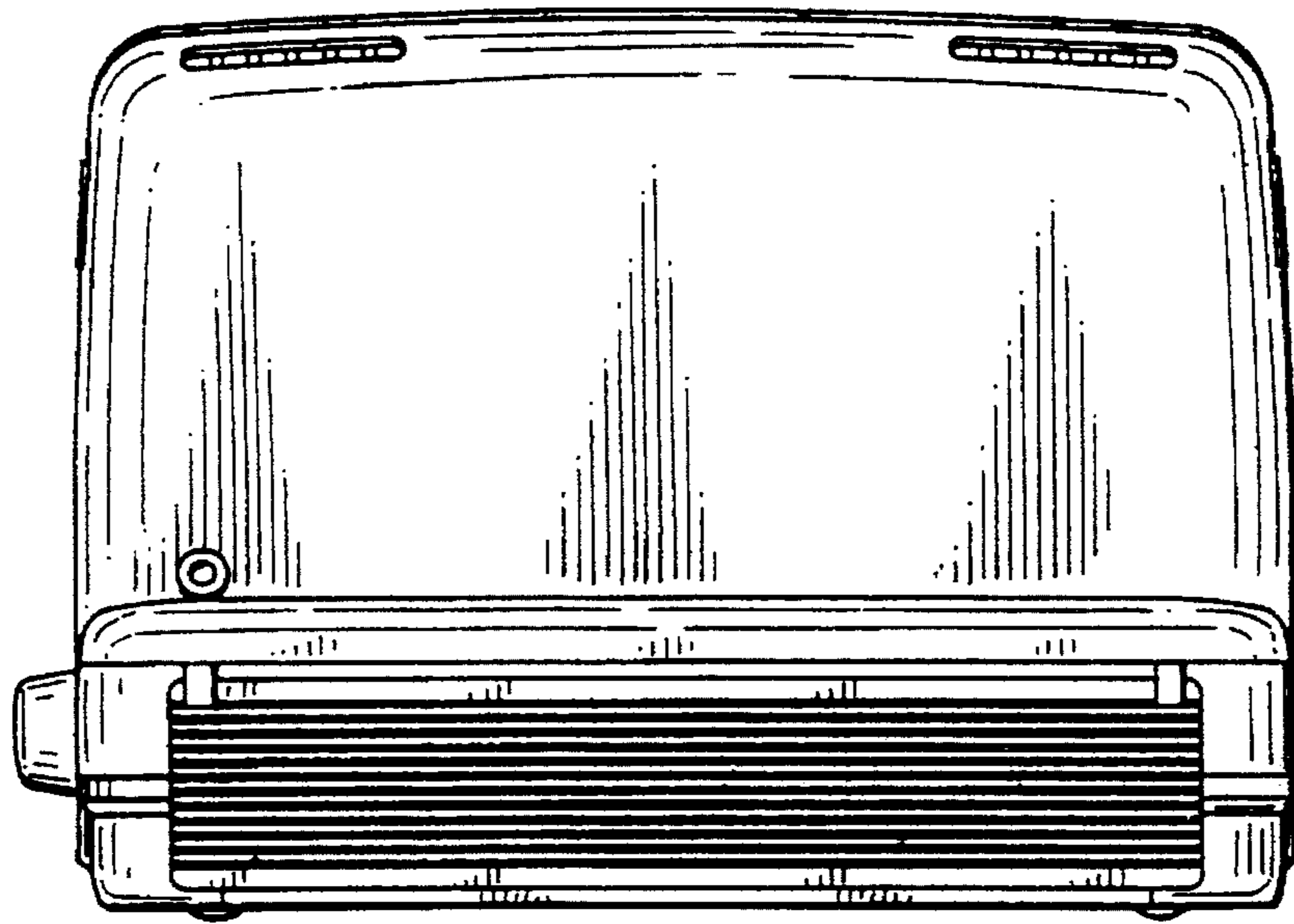

FIG. 7

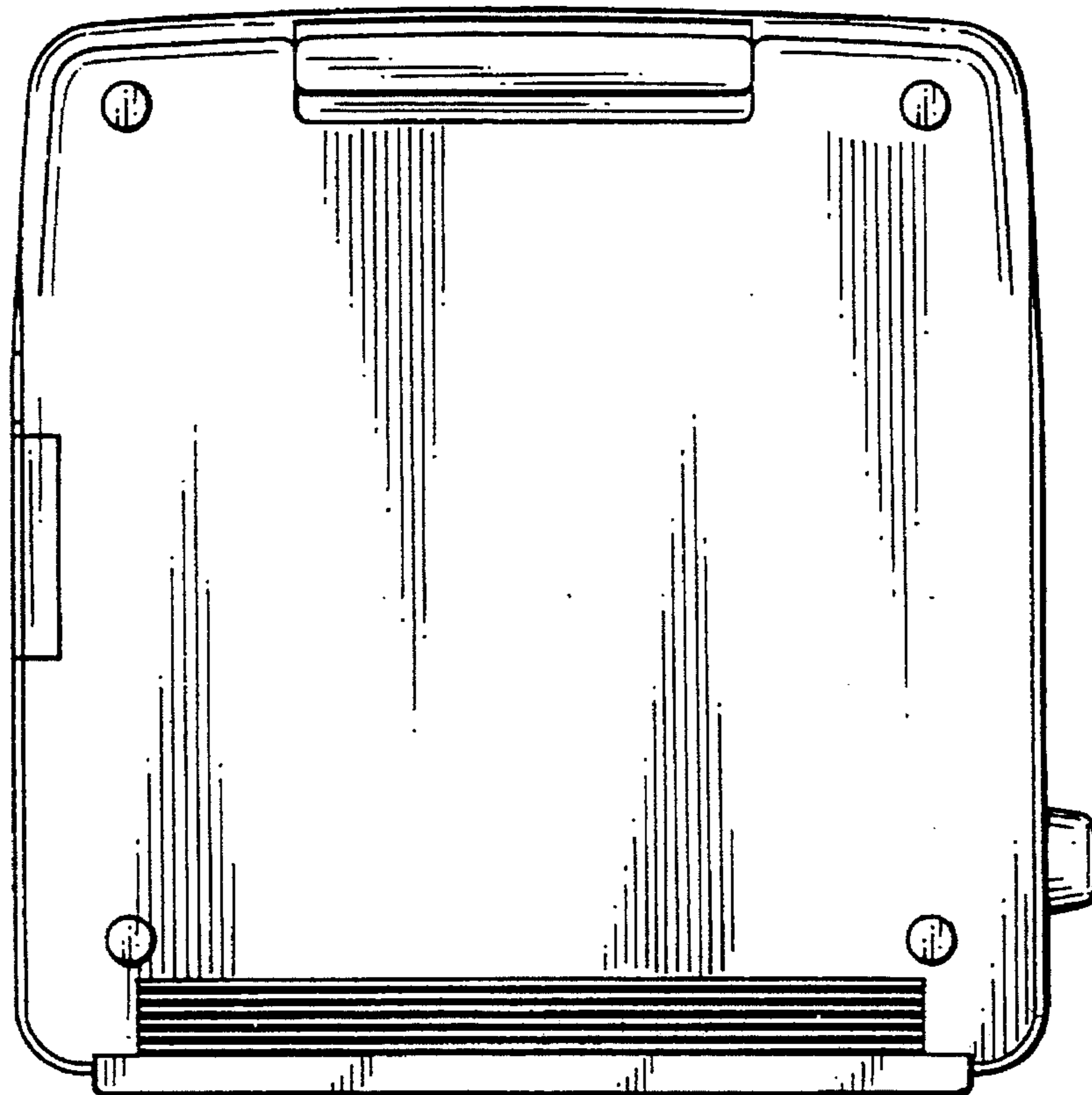

FIG. 8

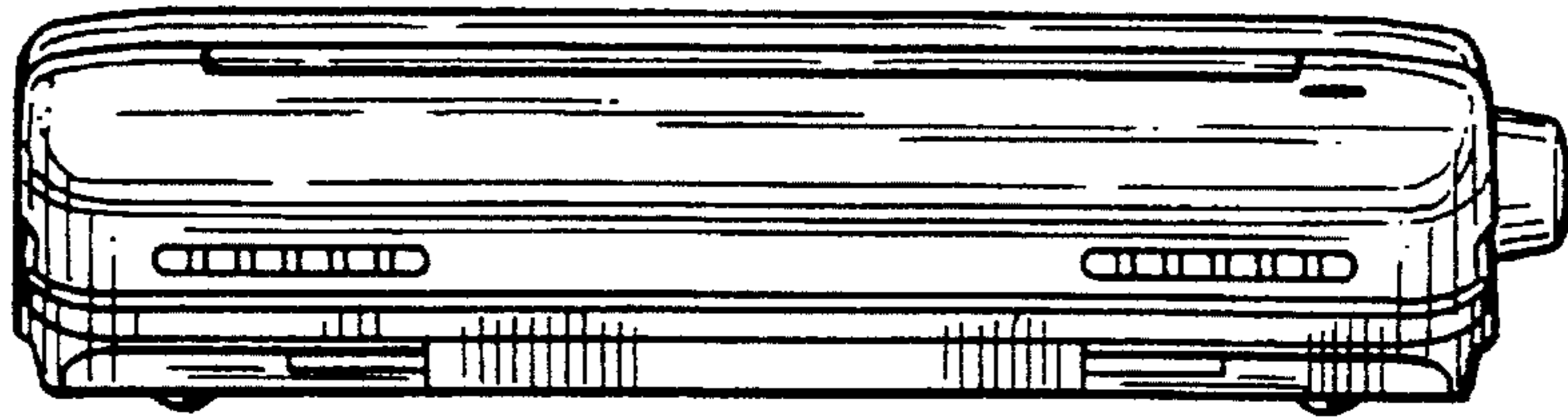

FIG. 9

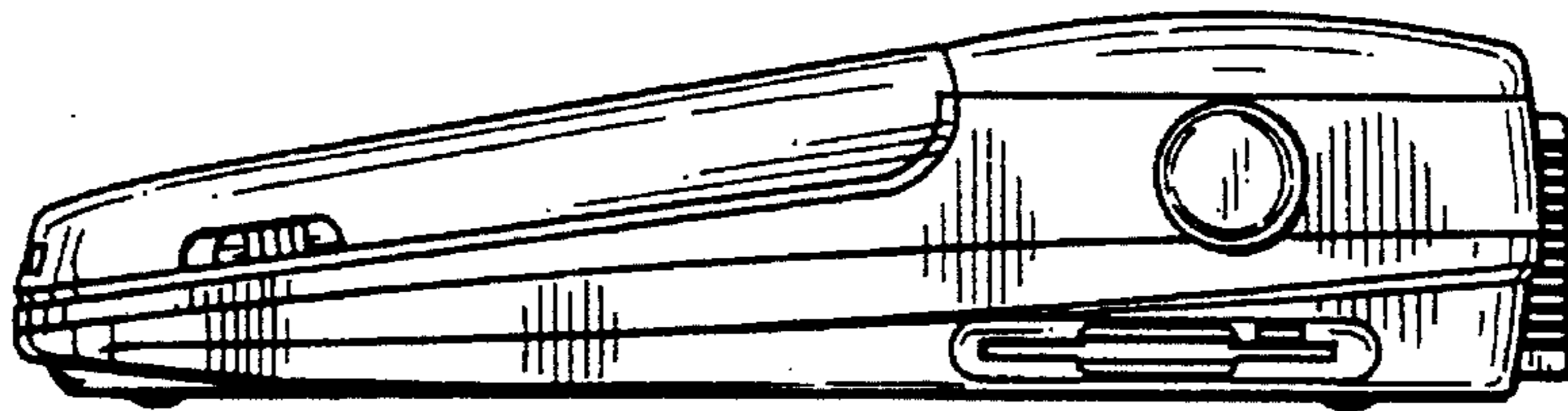

FIG. 10

