



US00D364833S

United States Patent [19]

[11] **Patent Number: Des. 364,833**

Matoba

[45] **Date of Patent: **Dec. 5, 1995**

[54] **BUCKLE**

5,243,741 9/1993 Fudaki et al. 24/200

[75] Inventor: **Hiroshi Matoba**, Toyama, Japan

Primary Examiner—Ralf T. Seifert
Attorney, Agent, or Firm—Hill, Steadman & Simpson

[73] Assignee: **Yoshida Kogyo, K.K.**, Tokyo, Japan

[57] **CLAIM**

[**] Term: **14 Years**

The ornamental design for buckle, as shown.

[21] Appl. No.: **5,820**

DESCRIPTION

[22] Filed: **Mar. 11, 1993**

[52] **U.S. Cl.** **D11/218**

[58] **Field of Search** D11/200, 201,
D11/215-225; 24/200, 171, 218, 307

FIG. 1 is a front view of a buckle;
FIG. 2 is a rear view of the buckle of FIG. 1;
FIG. 3 is a plan view of the buckle of FIG. 1;
FIG. 4 is a base view of the buckle of FIG. 1;
FIG. 5 is a right side view of the buckle of FIG. 1;
FIG. 6 is a cross-sectional view taken along the line 6—6 of FIG. 1;
FIG. 7 is a rear perspective view of the buckle of FIG. 1;
and,
FIG. 8 is a front perspective view of the buckle of FIG. 1.

[56] **References Cited**

U.S. PATENT DOCUMENTS

D. 328,045	7/1992	Matoba	D11/218
4,637,099	1/1987	Kasai	24/200
4,677,711	7/1987	Anscher	24/200
4,791,709	12/1988	Fildan	24/171

1 Claim, 3 Drawing Sheets

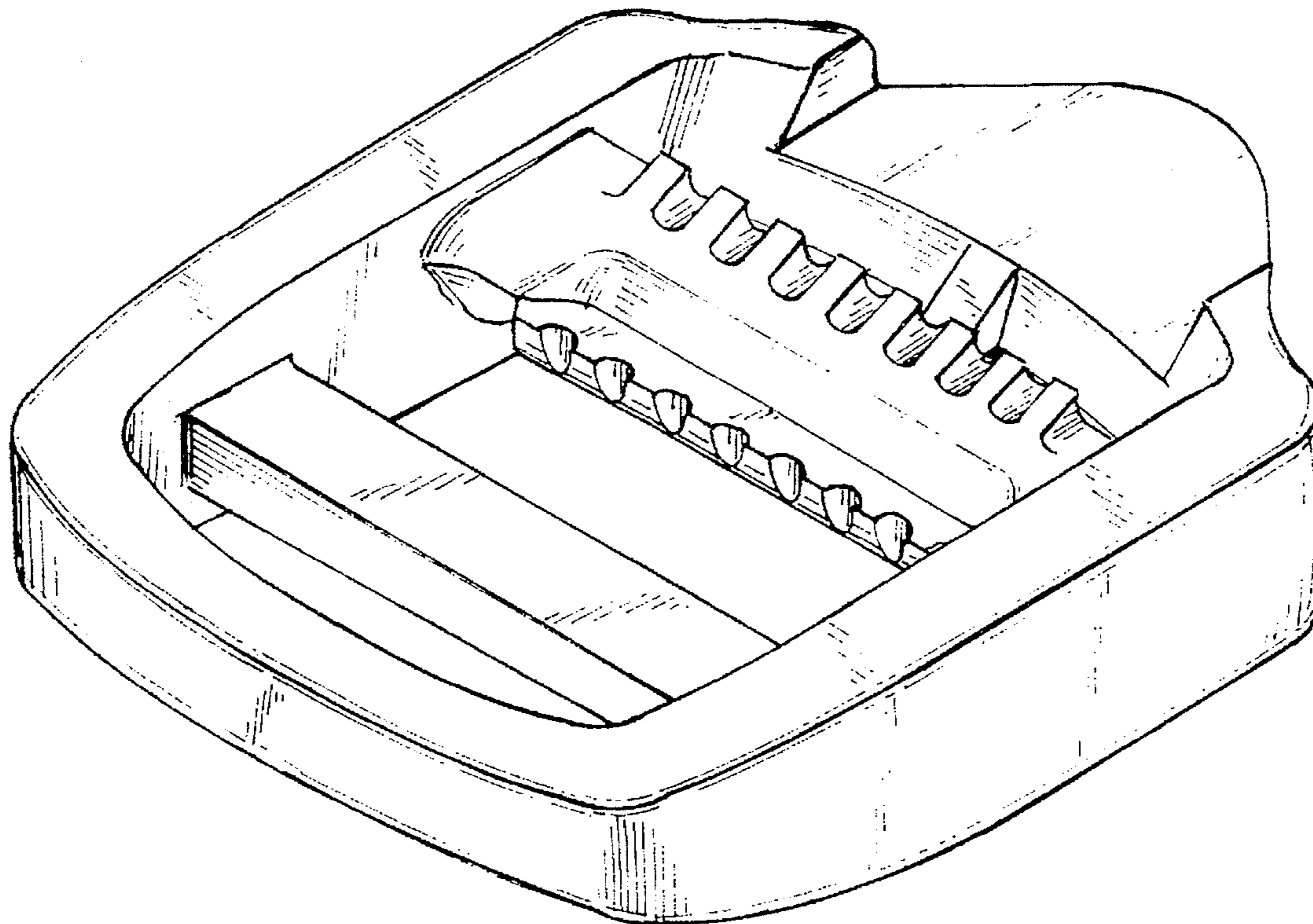

FIG. 1

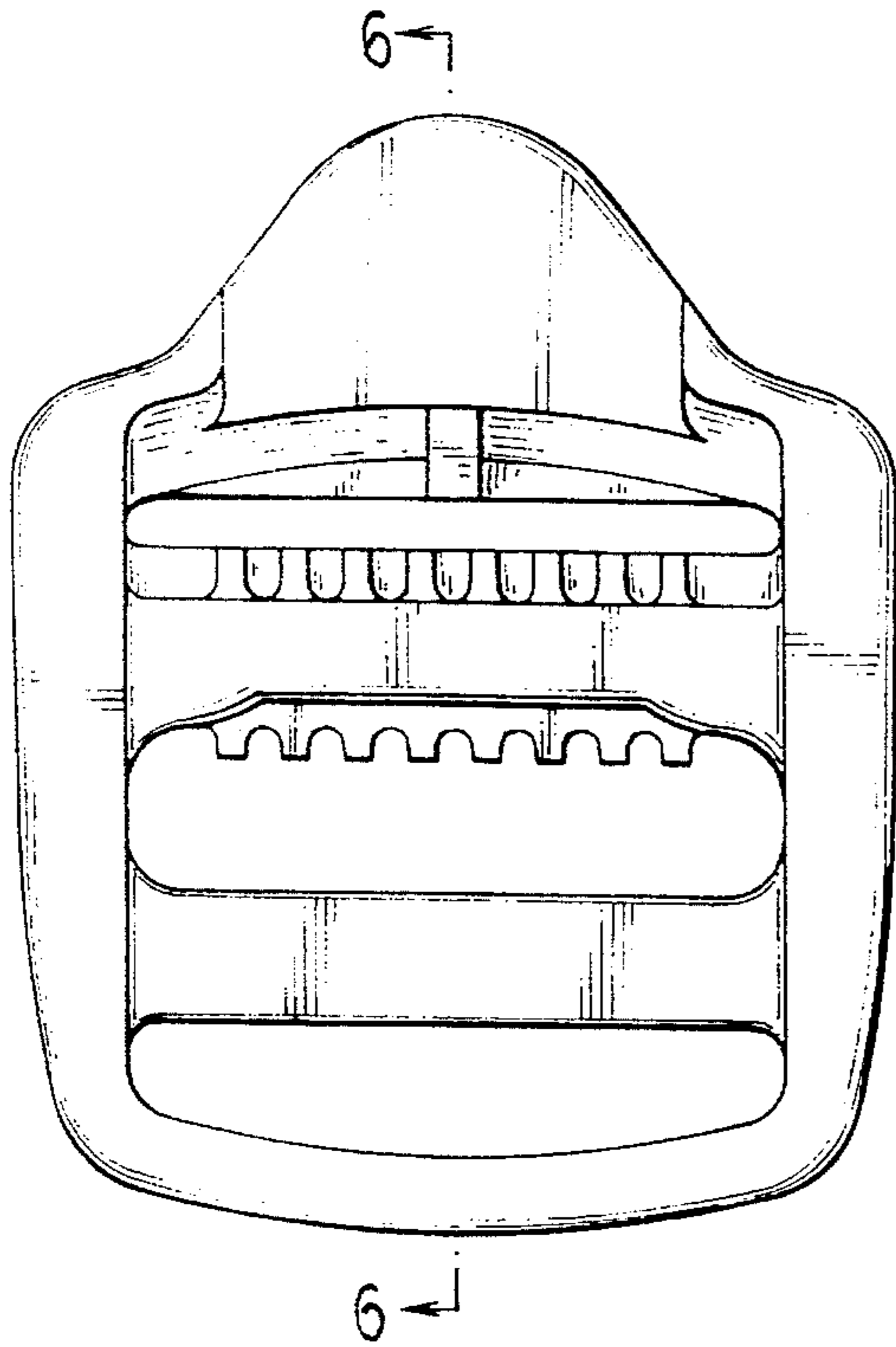

FIG. 2

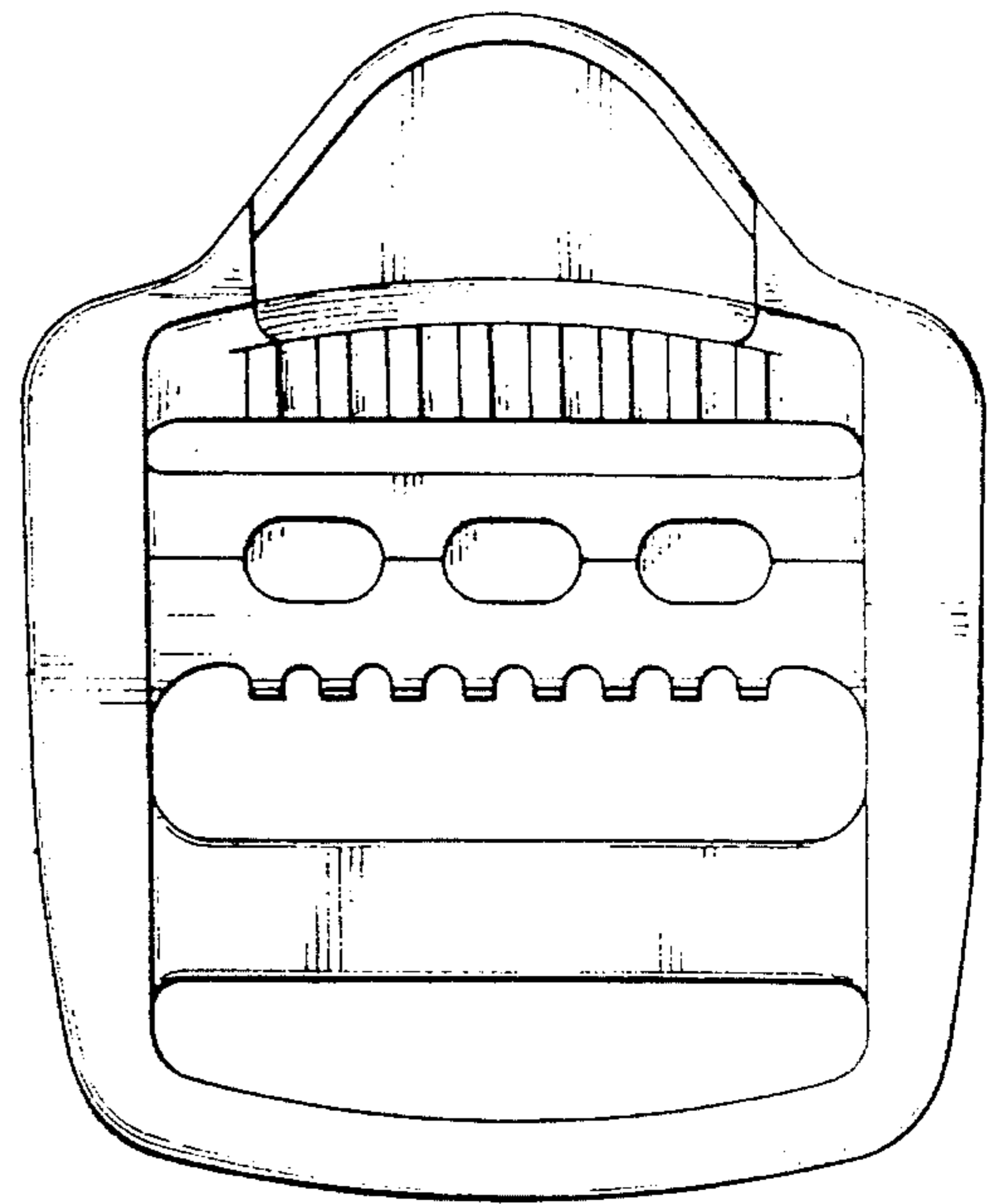

FIG. 3

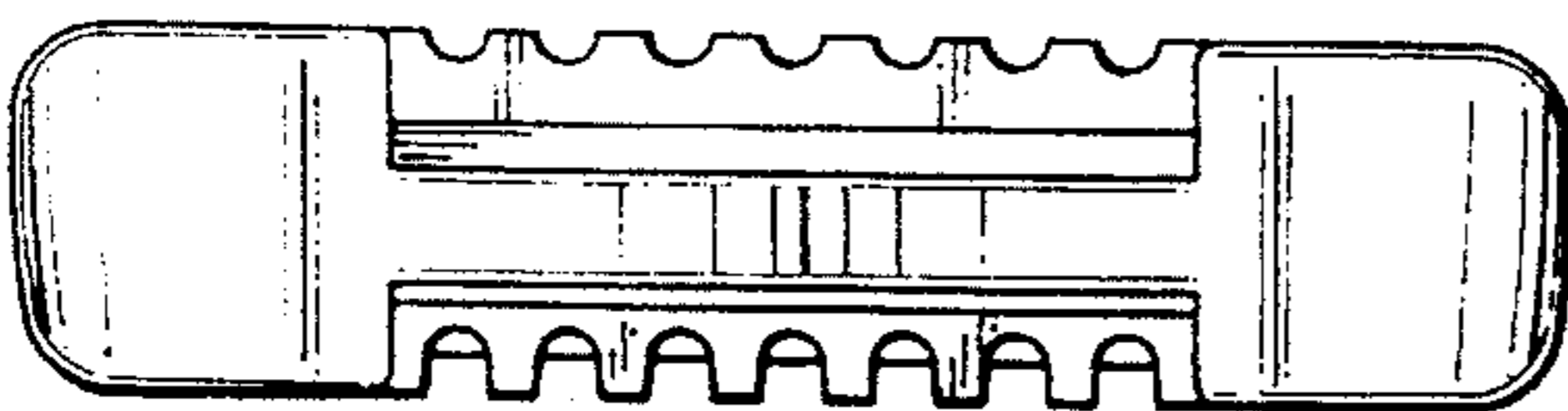

FIG. 4

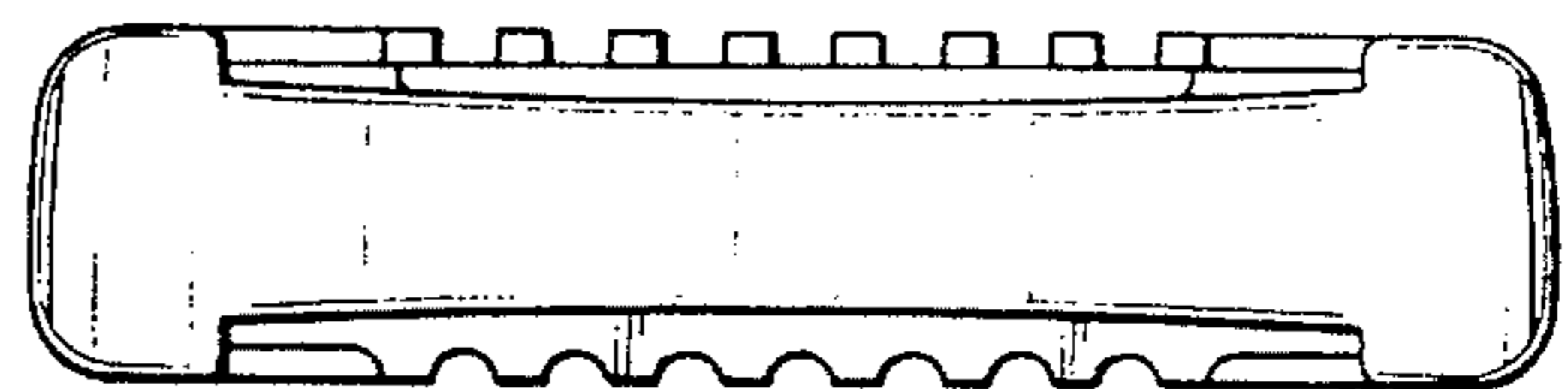

FIG. 5

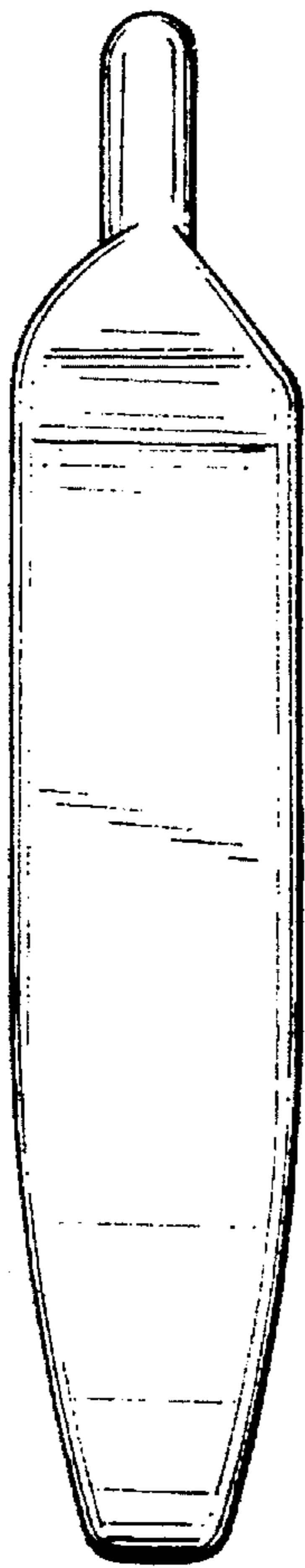

FIG. 6

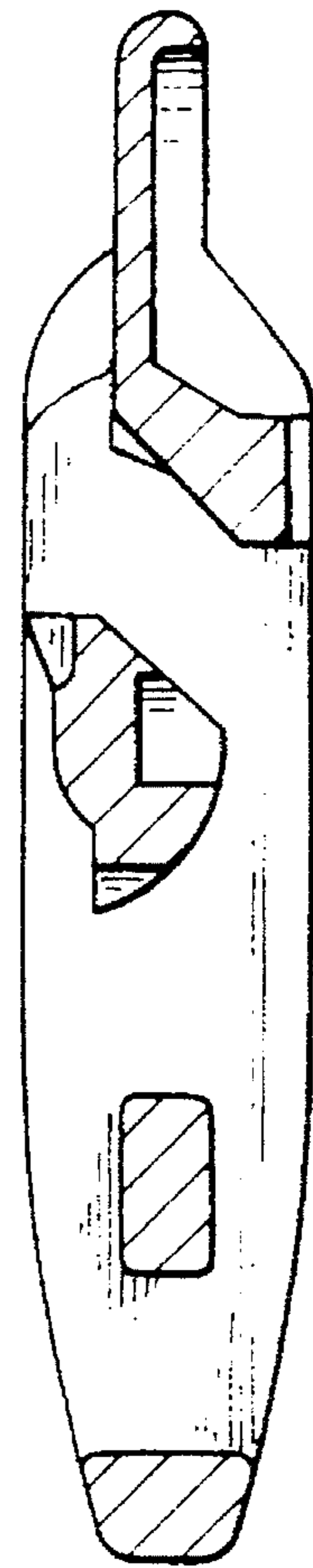

FIG. 7

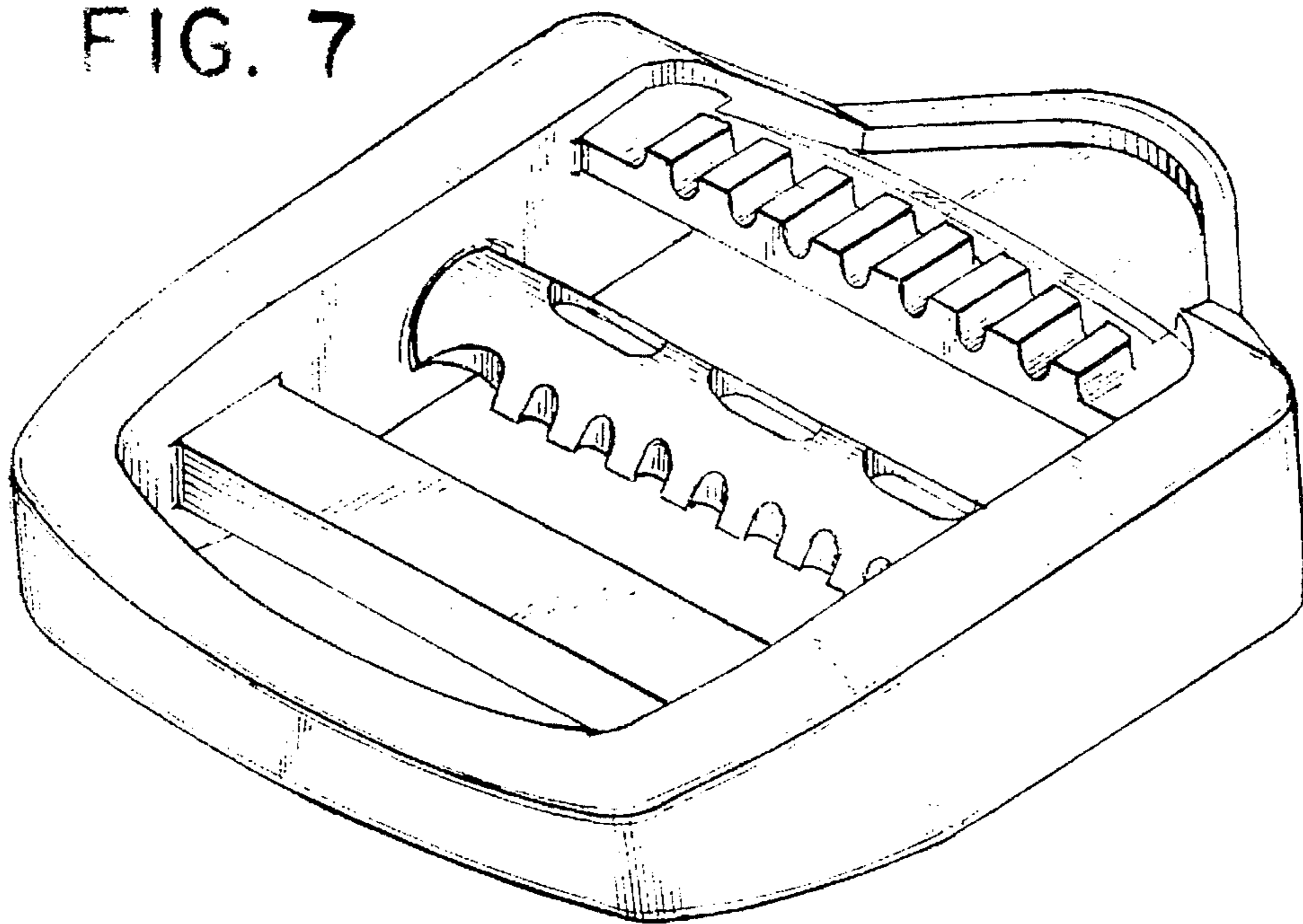

FIG. 8

