



US00D364740S

# United States Patent [19]

[11] Patent Number: Des. 364,740

Loew

[45] Date of Patent: \*\*\* Dec. 5, 1995

[54] SET OF BRISTLES FOR A TOOTHBRUSH

[75] Inventor: Christopher Loew, San Francisco, Calif.

[73] Assignee: Gillette Canada Inc., Kirkland, Canada

[\*] Notice: The portion of the term of this patent subsequent to May 23, 2009, has been disclaimed.

[\*\*] Term: 14 Years

[21] Appl. No.: 1,064

[22] Filed: Nov. 2, 1992

[52] U.S. Cl. .... D4/104

[58] Field of Search ..... D4/101, 104-112, D4/130, 134; 15/159.1, 160, 167.1, 167.2, 207.2, DIG. 5, DIG. 6; 401/268

[56] References Cited

### U.S. PATENT DOCUMENTS

D. 49,472	8/1916	Dierke	.....	D4/105
D. 201,867	8/1965	Newman	.....	D4/104
D. 239,221	3/1976	Wasserman	.....	D4/104
D. 248,696	8/1978	Greenberg	.....	D4/104
D. 259,976	7/1981	Seelig	.....	D4/104
D. 272,688	2/1984	Stocchi	.....	D4/110
D. 272,689	2/1984	Stocchi	.....	D4/110
D. 272,690	2/1984	Stocchi	.....	D4/110
D. 273,635	5/1984	Stocchi	.....	D4/104
D. 289,703	5/1987	Yaffe	.....	D4/104
D. 292,448	10/1987	Vianello	.....	D4/104
D. 319,148	8/1991	Emily	.....	D4/104
D. 334,288	3/1993	Witzig-Jaggi	.....	D4/104
335,345	2/1886	Estabrook	.....	15/167.1
669,402	3/1901	Rose	.....	15/167.1
1,018,927	2/1912	Sarrazin	.....	D4/104 X
1,337,173	4/1920	White	.....	15/167.1 X
1,440,785	1/1923	Levis	.....	15/167.1
1,456,535	5/1923	Cartwright	.....	D4/104 X
1,639,880	8/1927	Butler	.....	15/167.1
1,642,465	9/1927	Sheetz	.....	15/167.1
1,927,365	9/1933	Frolio	.....	15/167.1
2,312,828	3/1943	Adamsson	.....	401/268
3,188,673	6/1965	Newman	.....	15/167.1
3,378,870	4/1968	Matsunaga	.....	15/167.1
3,678,528	7/1972	Haije	.....	15/167.1
3,722,020	3/1973	Hills	.....	15/167.1
3,742,549	7/1973	Scopp et al.	.....	15/167.1

4,020,521	5/1977	Velasquez	.....	15/167.1
4,570,282	2/1986	Kaufman et al.	.....	15/167.1
4,712,267	12/1987	Cheng	.....	15/172
4,800,608	1/1989	Key	.....	15/167.1
4,847,936	7/1989	Moglianesi et al.	.....	15/167.1
4,882,803	11/1989	Rogers et al.	.....	15/167.1
4,894,880	1/1990	Aznovoorian	.....	D4/104 X
5,046,212	9/1991	O'Conke	.....	15/105

### FOREIGN PATENT DOCUMENTS

818794	5/1952	Germany	.....	15/167.1
--------	--------	---------	-------	----------

### OTHER PUBLICATIONS

Sample of "Ortho" brush, manufactured and sold by Oral-B Laboratories, Redwood City, Calif. (1989) (Sample filed in copending application Ser. No. 29/001,082).

Primary Examiner—A. Hugo Word  
Assistant Examiner—Lavone D. Tabor  
Attorney, Agent, or Firm—Chester Cekala

### [57] CLAIM

The ornamental design for a set of bristles for a toothbrush, as shown.

### DESCRIPTION

FIG. 1 is a top, front and right side perspective view of a set of bristles for a toothbrush showing my new design (unclaimed environmental structure being shown in broken lines);

FIG. 2 is a top plan view thereof (unclaimed environmental structure being shown in broken lines);

FIG. 3 is a front elevational view thereof (unclaimed environmental structure being shown in broken lines);

FIG. 4 is a right side elevational view thereof where the left side view is a mirror image (unclaimed environmental structure being shown in broken lines);

FIG. 5 is a rear elevational view thereof (unclaimed environmental structure being shown by broken lines); and,

FIG. 6 is a top, rear and left side perspective view of the toothbrush head of FIG. 1 (Unclaimed environmental structure being shown in broken lines).

The broken lines showing the toothbrush head and neck structure is for illustrative purposes only and forms no part of the claimed design.

1 Claim, 3 Drawing Sheets

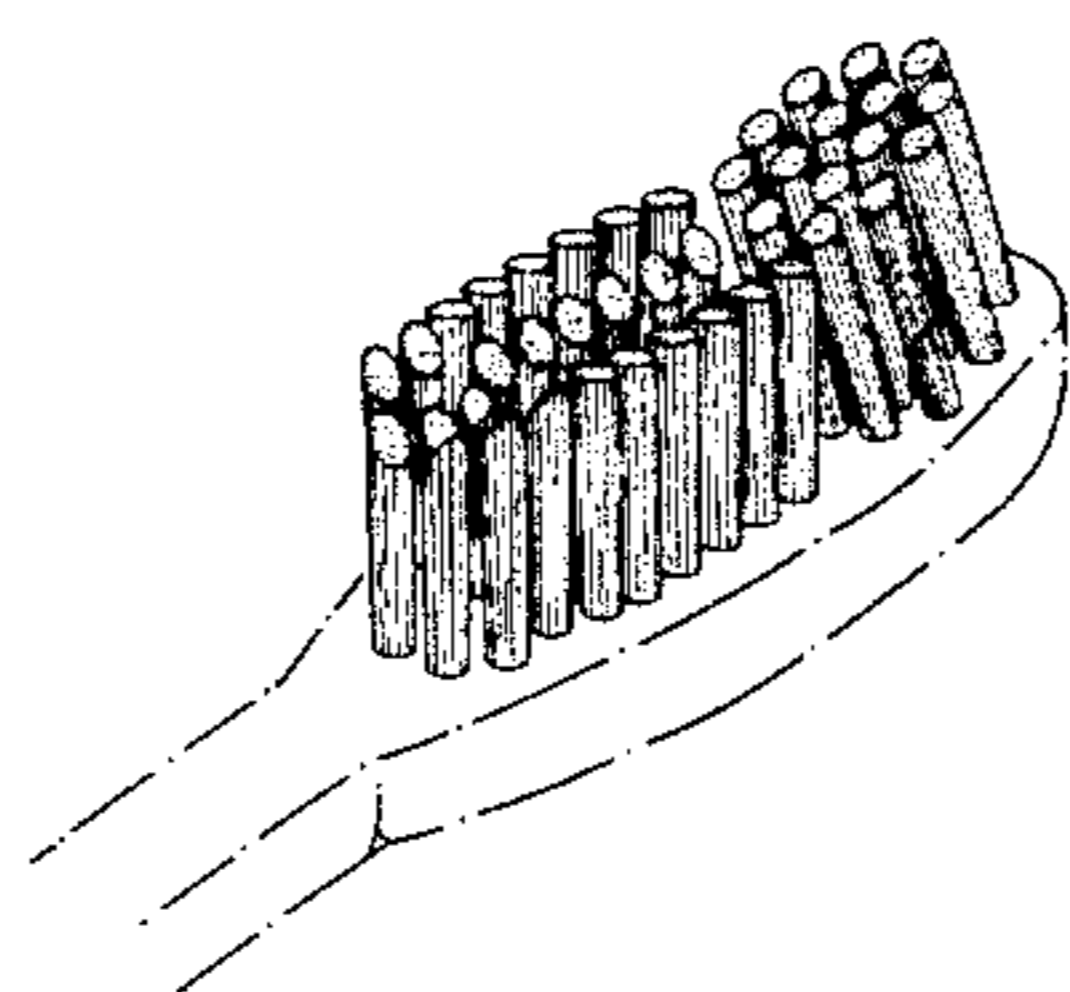
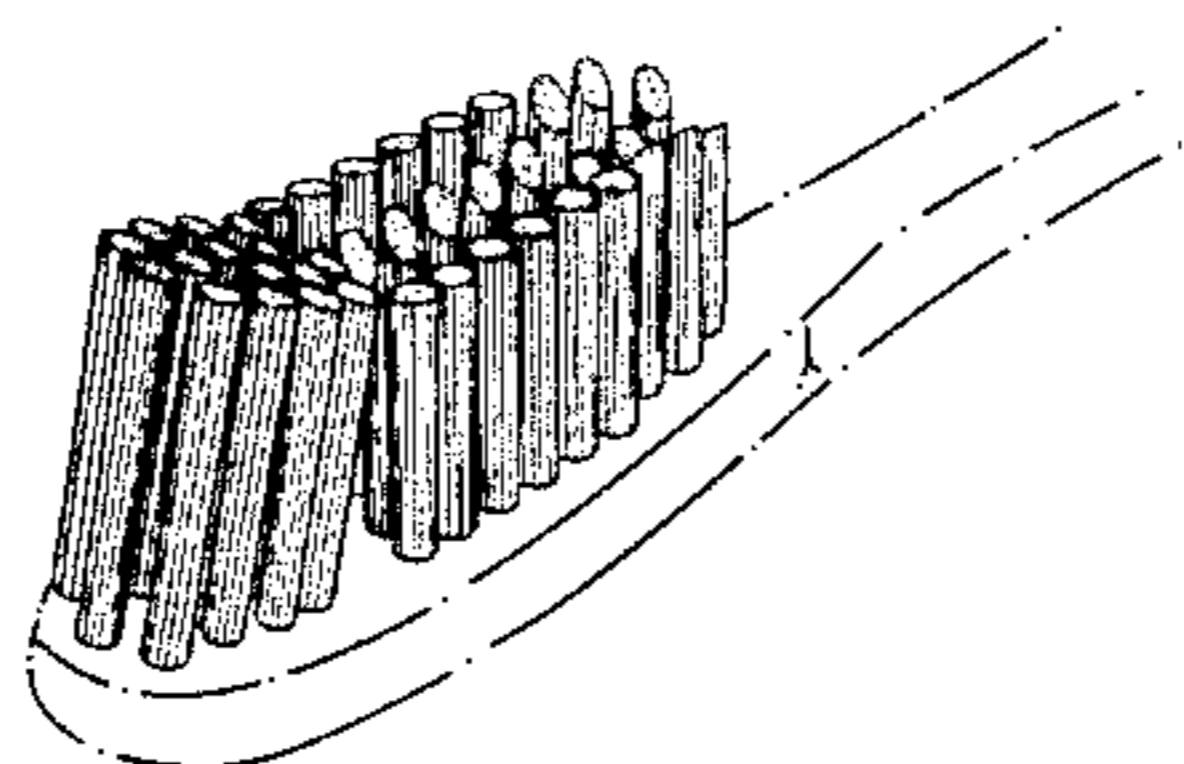

*FIG. 1*

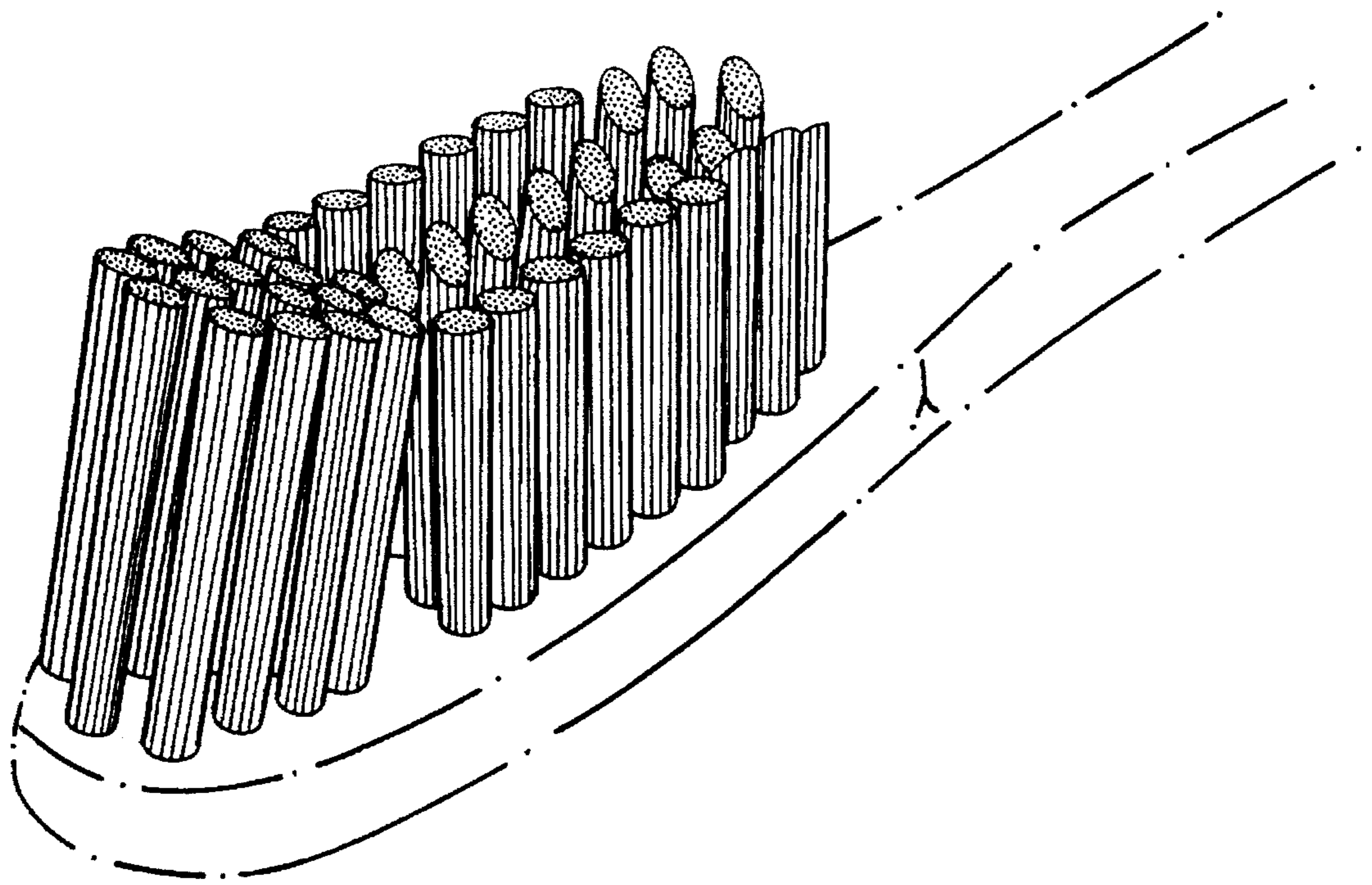



FIG. 2

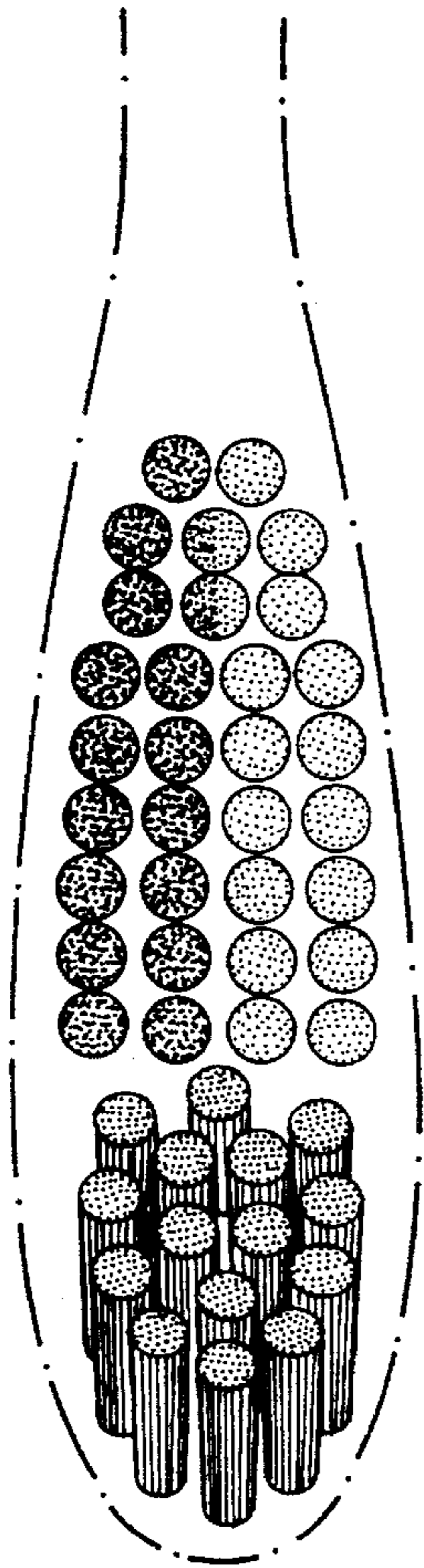

FIG. 3

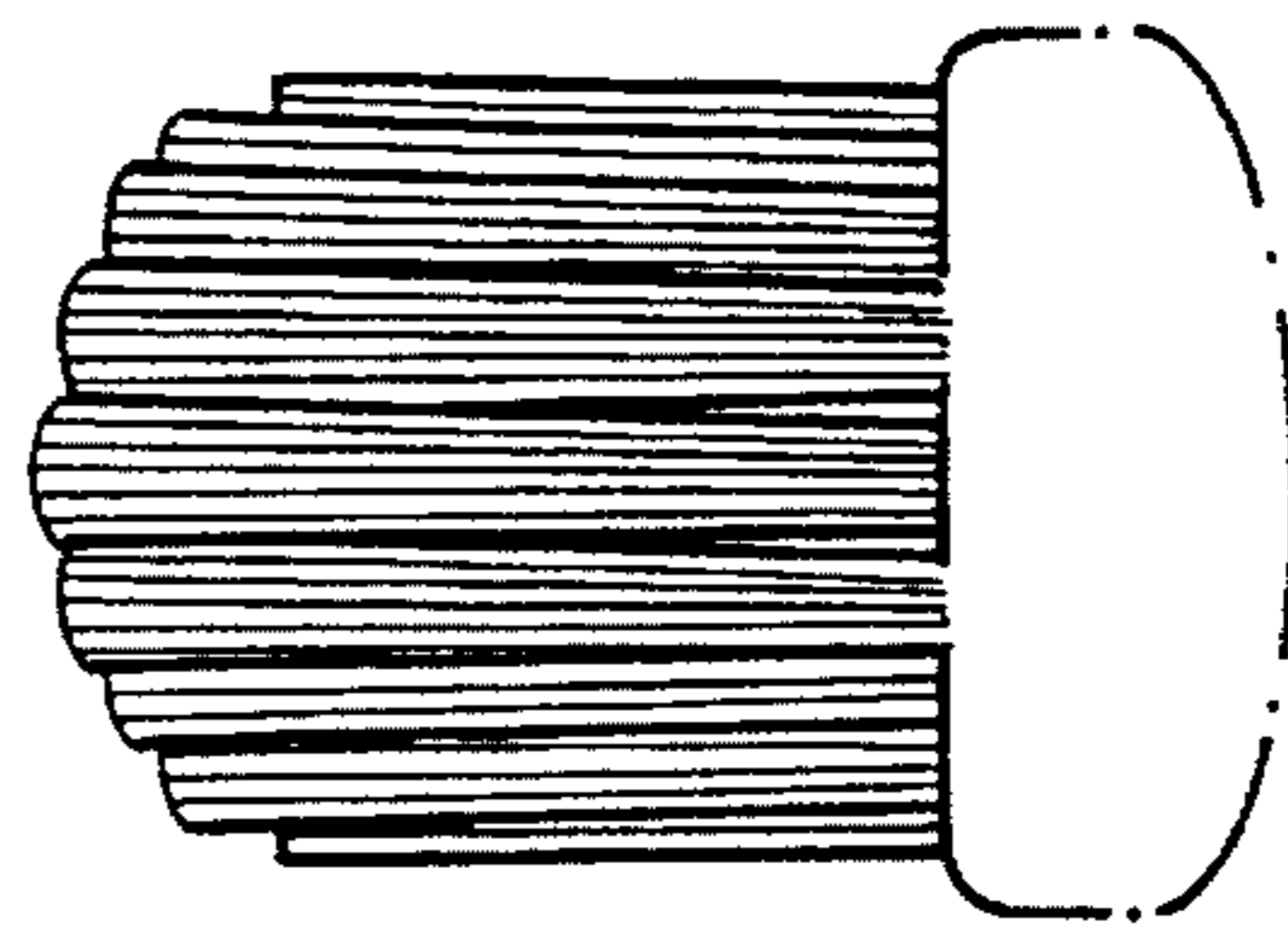

FIG. 4

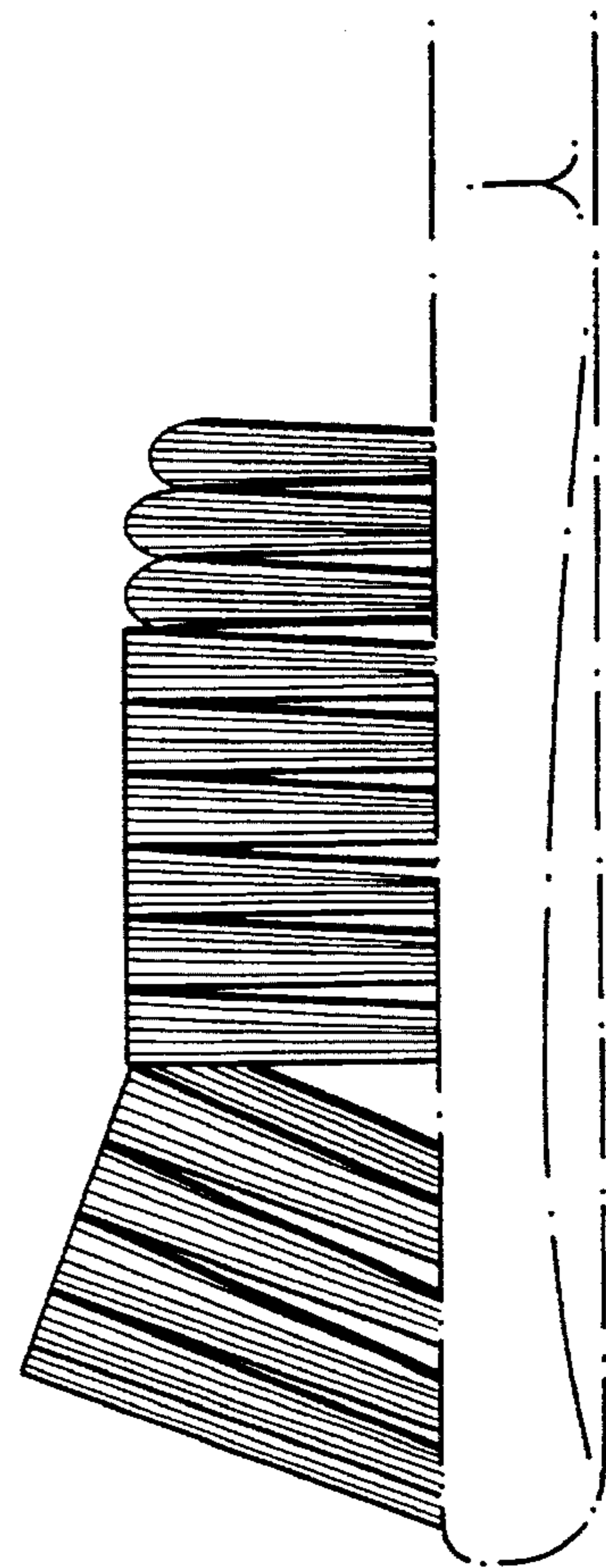
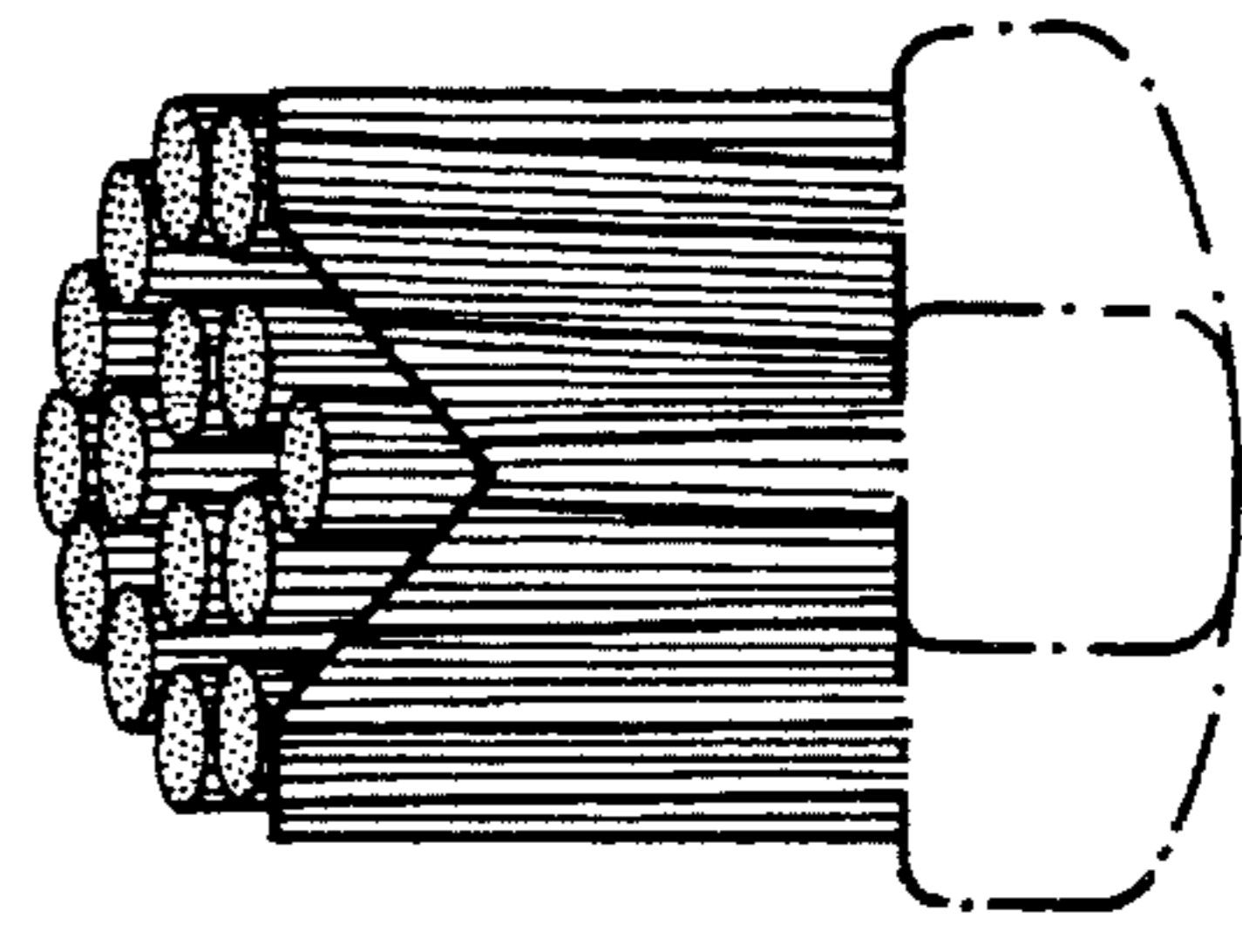

FIG. 5



*FIG. 6*

