



US00D364641S

United States Patent [19]
Osterhout

[11] **Patent Number:** **Des. 364,641**
[45] **Date of Patent:** ****Nov. 28, 1995**

[54] **PEN RECORDER HOUSING**

[75] Inventor: **Ralph F. Osterhout**, San Francisco, Calif.

[73] Assignee: **Tiger Electronics, Inc.**, Vernon Hills, Ill.

[**] Term: **14 Years**

[21] Appl. No.: **33,206**

[22] Filed: **Jan. 6, 1995**

[52] U.S. Cl. **D19/36**; D19/48; D19/51;
D19/56; 401/195

[58] **Field of Search** D19/35, 36, 41-51,
D19/54-58, 81-85; 401/52, 195, 209; 395/2.81;
381/18, 27; 369/64, 58; 434/308; 379/355,
361, 110

[56] **References Cited**

U.S. PATENT DOCUMENTS

D. 80,646 3/1930 Thomas et al. D19/42
D. 159,247 7/1950 Bodor D19/54
D. 191,554 10/1961 Bodor D19/46 X

D. 314,978 2/1991 Oka D19/41 X
D. 355,932 2/1995 Beffa D19/36
D. 356,113 3/1995 Maggio D19/36
4,541,630 9/1985 Dirks D19/36 X
4,763,355 8/1988 Cox 401/195 X
5,313,557 5/1994 Osterhout 395/2.81
5,368,406 11/1994 Hanshaw 401/195

Primary Examiner—Martie Thompson
Attorney, Agent, or Firm—Fitch, Even, Tabin & Flannery

[57] **CLAIM**

The ornamental design for the pen recorder housing, as shown and described.

DESCRIPTION

FIG. 1 is a perspective view of a pen recorder housing showing my new design;
FIG. 2 is a front plan view thereof;
FIG. 3 is a right side elevational view thereof;
FIG. 4 is a rear plan view thereof;
FIG. 5 is a left side elevational view thereof;
FIG. 6 is a top end view thereof; and,
FIG. 7 is a bottom end view thereof.

1 Claim, 2 Drawing Sheets

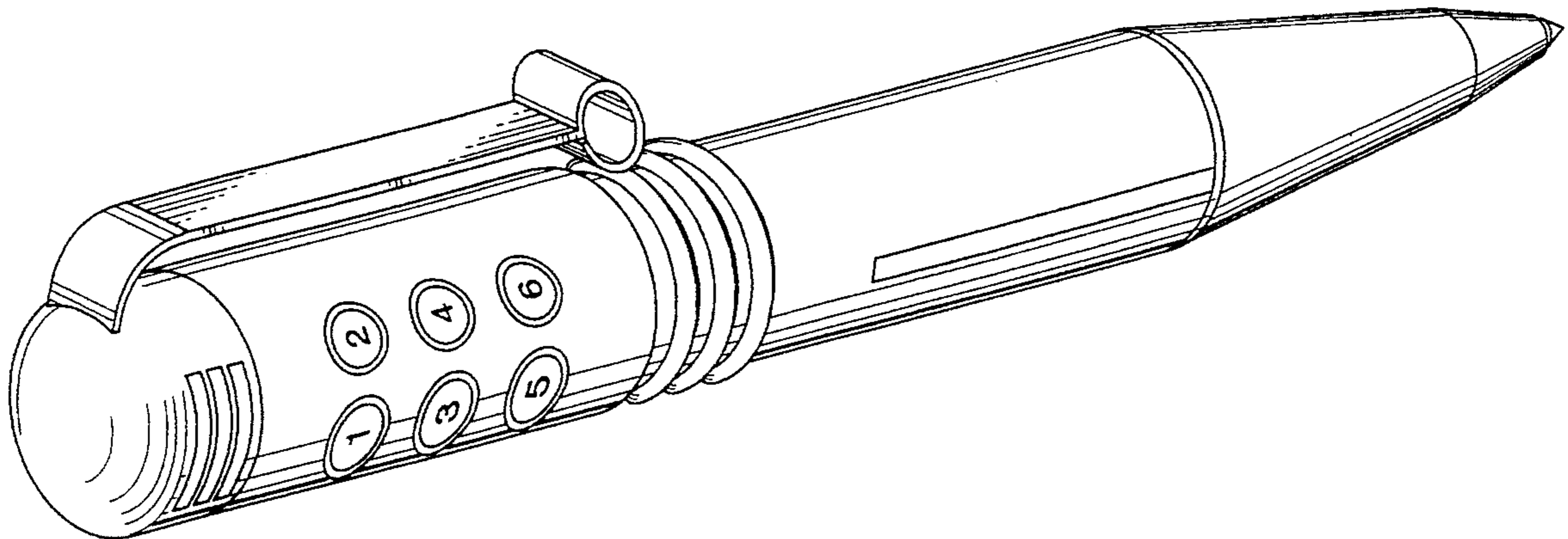

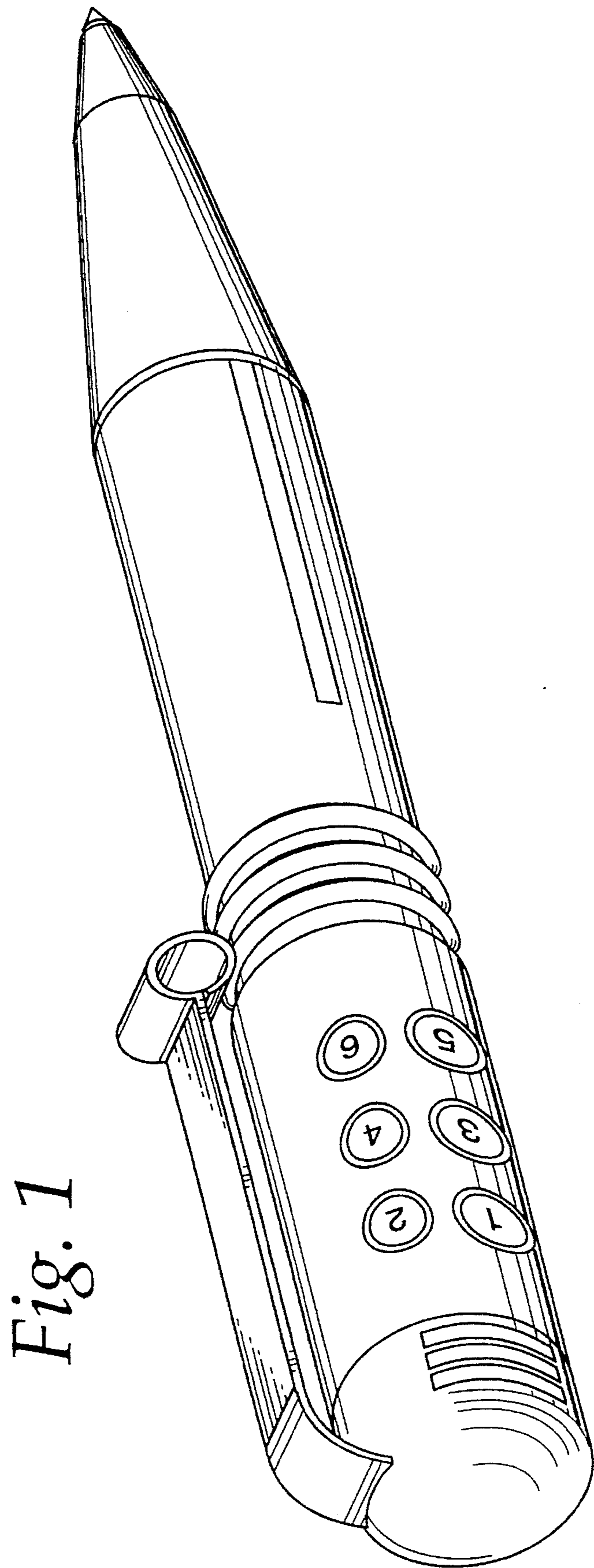

Fig. 1

Fig. 2

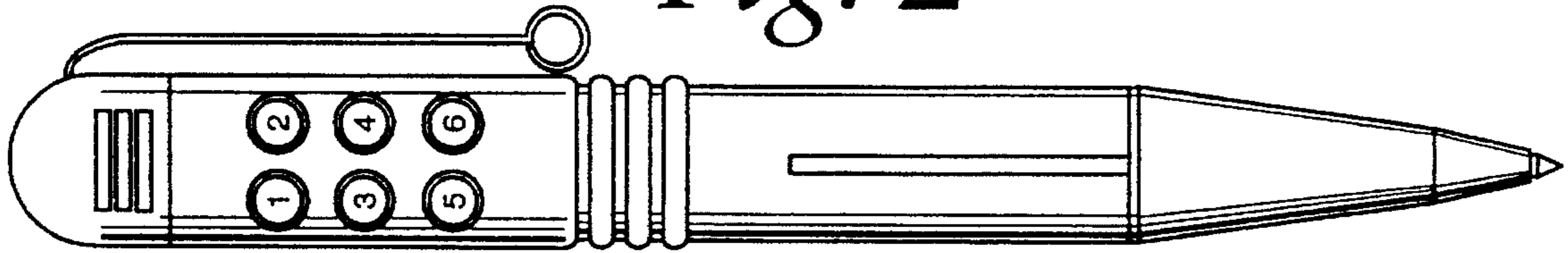

Fig. 3

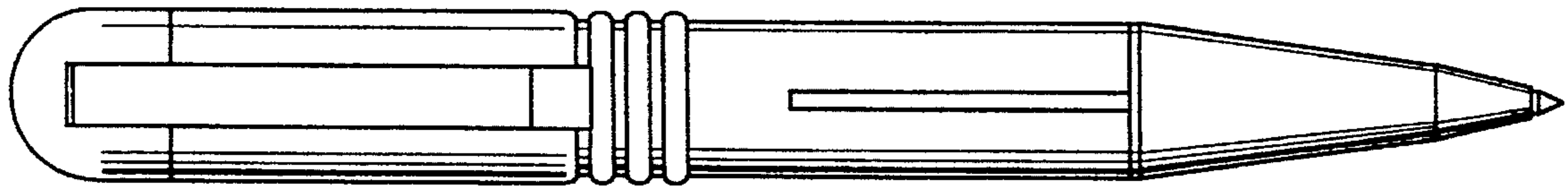

Fig. 4

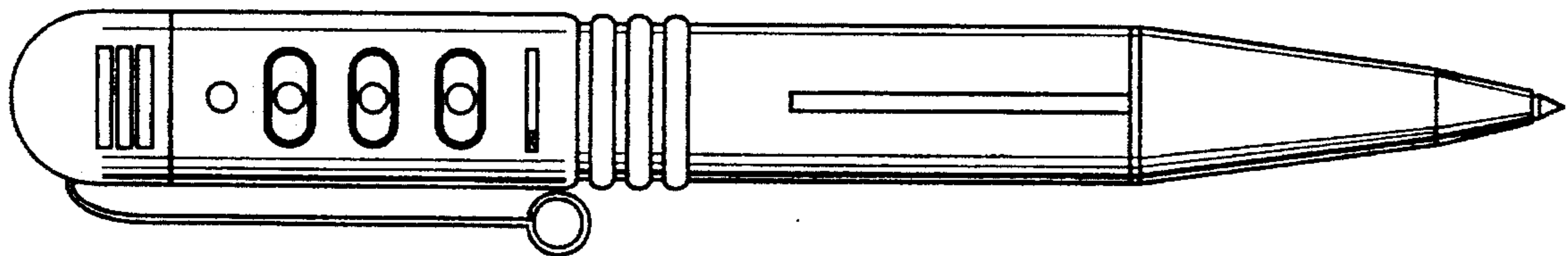

Fig. 5

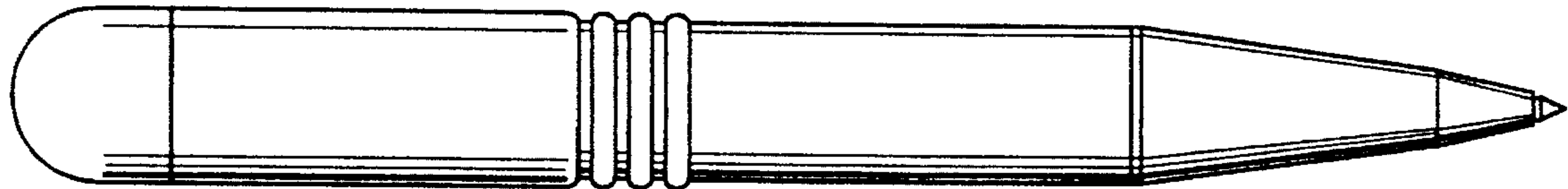

Fig. 6

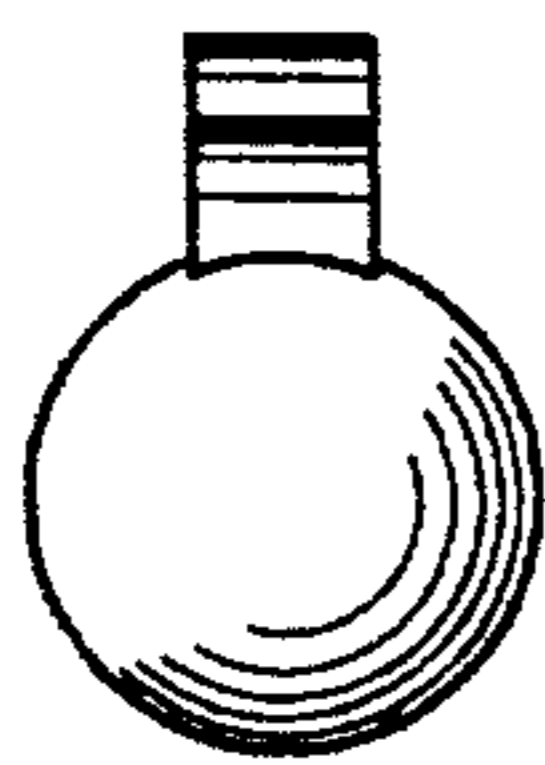

Fig. 7

