



US00D364533S

United States Patent [19]
Brophy

[11] **Patent Number: Des. 364,533**
[45] **Date of Patent: **Nov. 28, 1995**

[54] **PIE CRUST SHIELD**

Primary Examiner—Terry A. Wallace

[76] Inventor: **Marilyn J. Brophy**, 2703 Hatteras Pl.,
Davis, Calif. 95616

[57] **CLAIM**

[**] Term: **14 Years**

The ornamental design for a pie crust shield, as shown and described.

[21] Appl. No.: **29,058**

DESCRIPTION

[22] Filed: **Sep. 28, 1984**

FIG. 1 is a front elevational view of the pie crust shield showing my new design;

[52] U.S. Cl. **D7/387**

FIG. 2 is a rear elevational view thereof;

[58] Field of Search D7/387, 610, 672;
99/433, DIG. 15; 30/280, 305, 314, 315

FIG. 3 is a left side elevational view thereof;

FIG. 4 is a right side elevational view thereof;

[56] **References Cited**

FIG. 5 is a top plan view thereof;

FIG. 6 is a bottom plan view thereof; and,

FIG. 7 is an isometric view showing a use thereof.

U.S. PATENT DOCUMENTS

D. 289,614 5/1987 Sanchez et al. D7/392.1 X
4,170,302 10/1979 Baca D7/610 X
4,911,634 3/1990 Keener 99/433 X

1 Claim, 4 Drawing Sheets

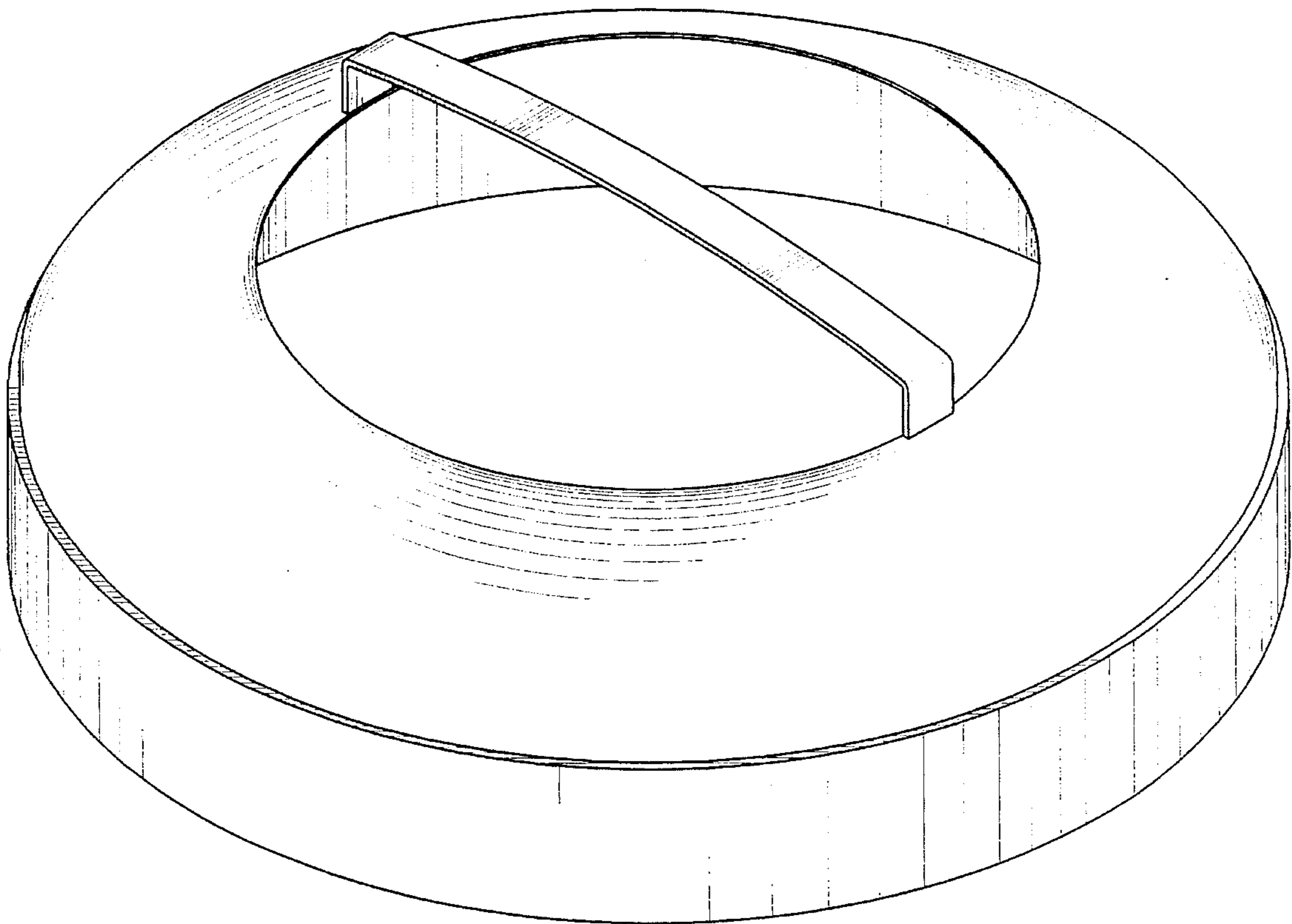

FIG. 1

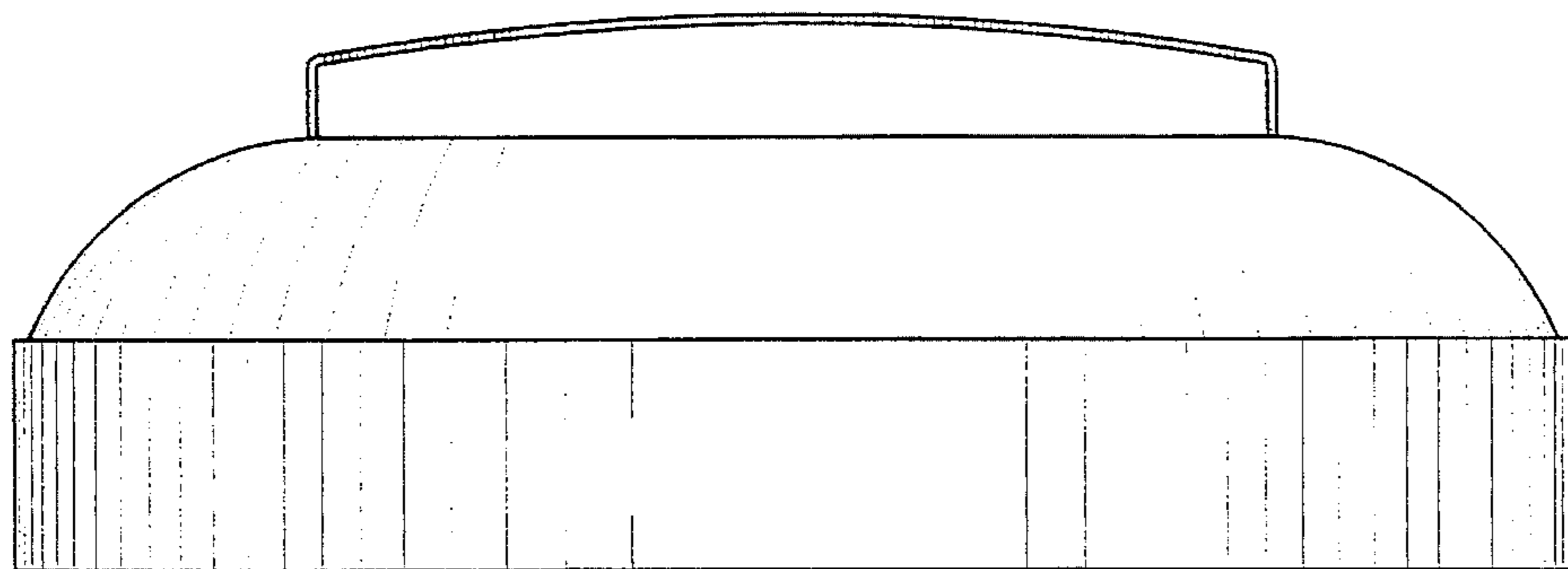

FIG. 2

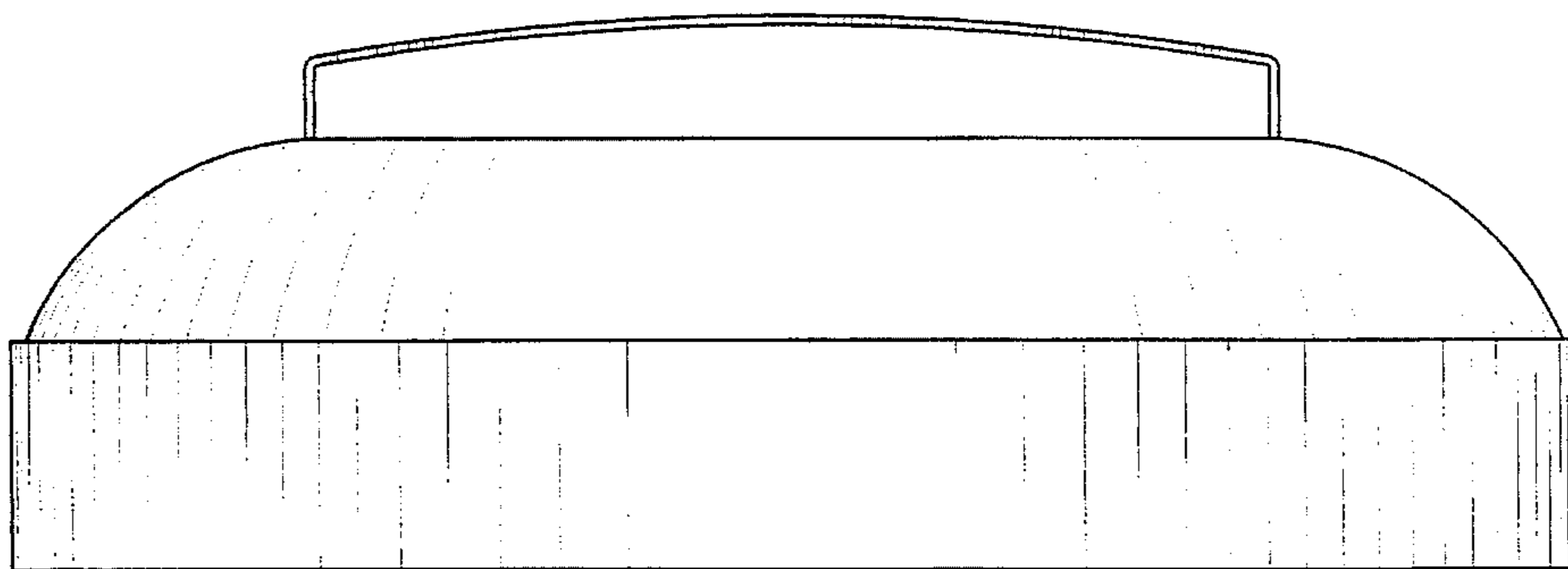

FIG. 3

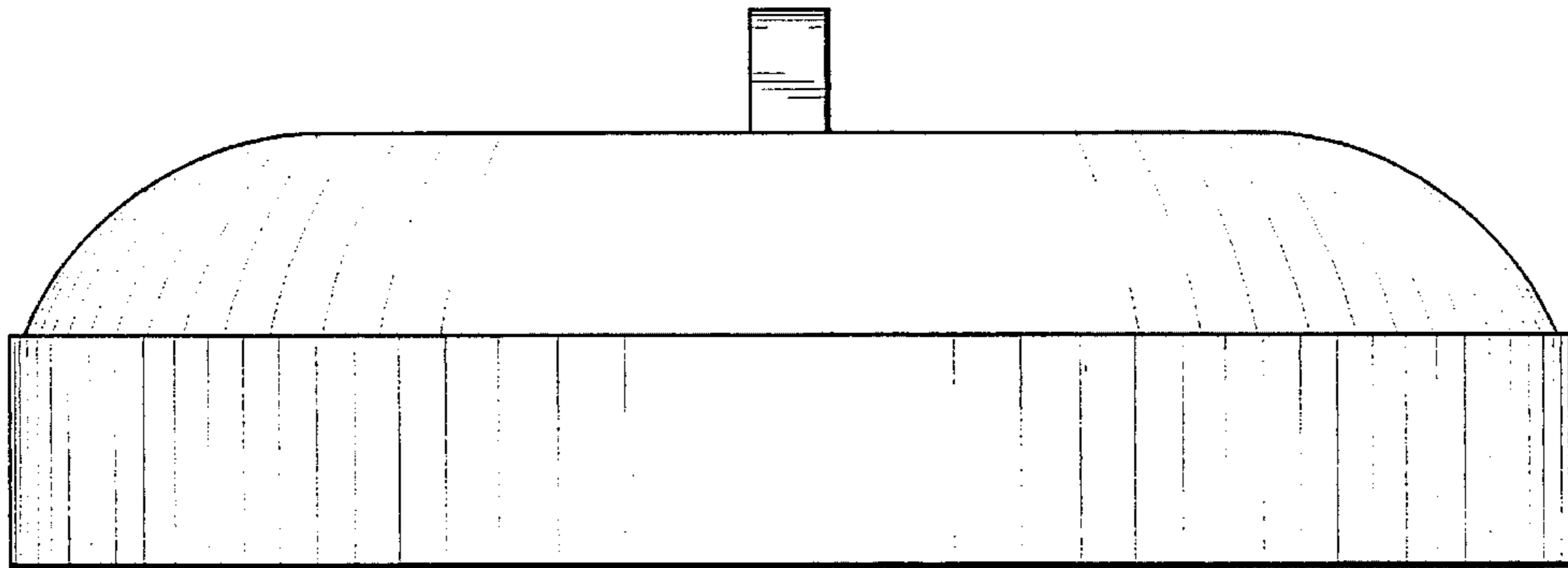

FIG. 4

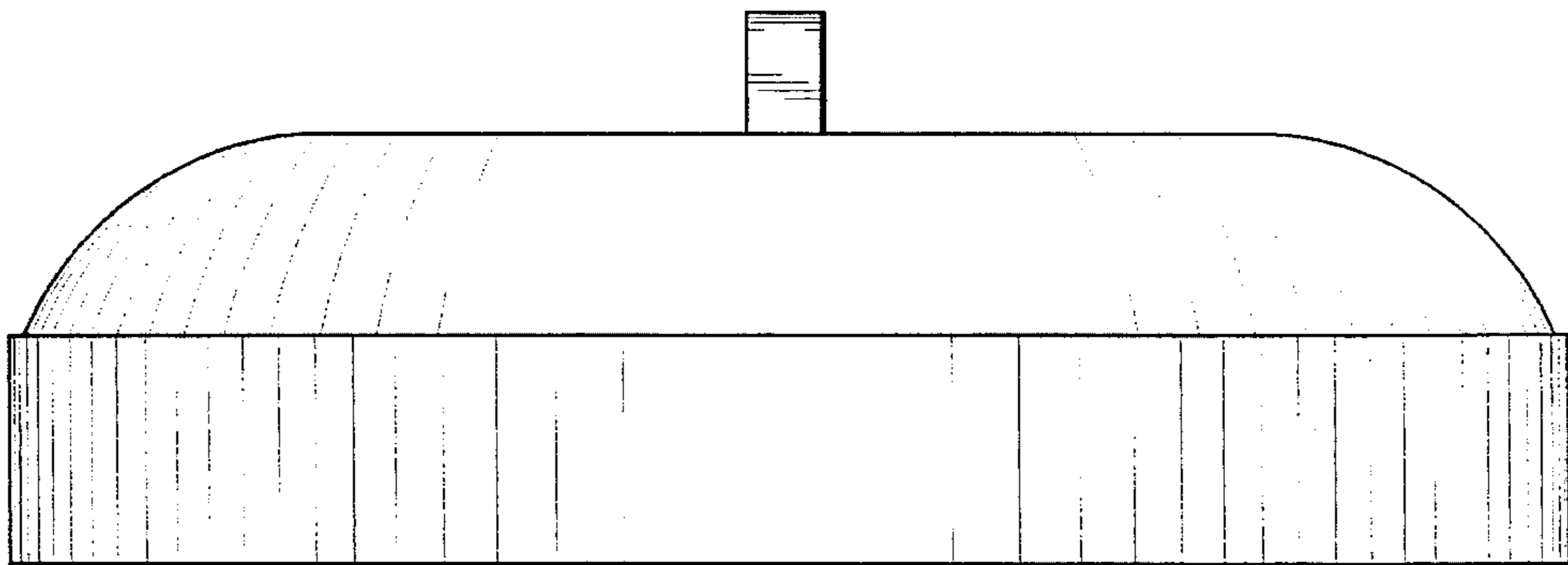

FIG. 5

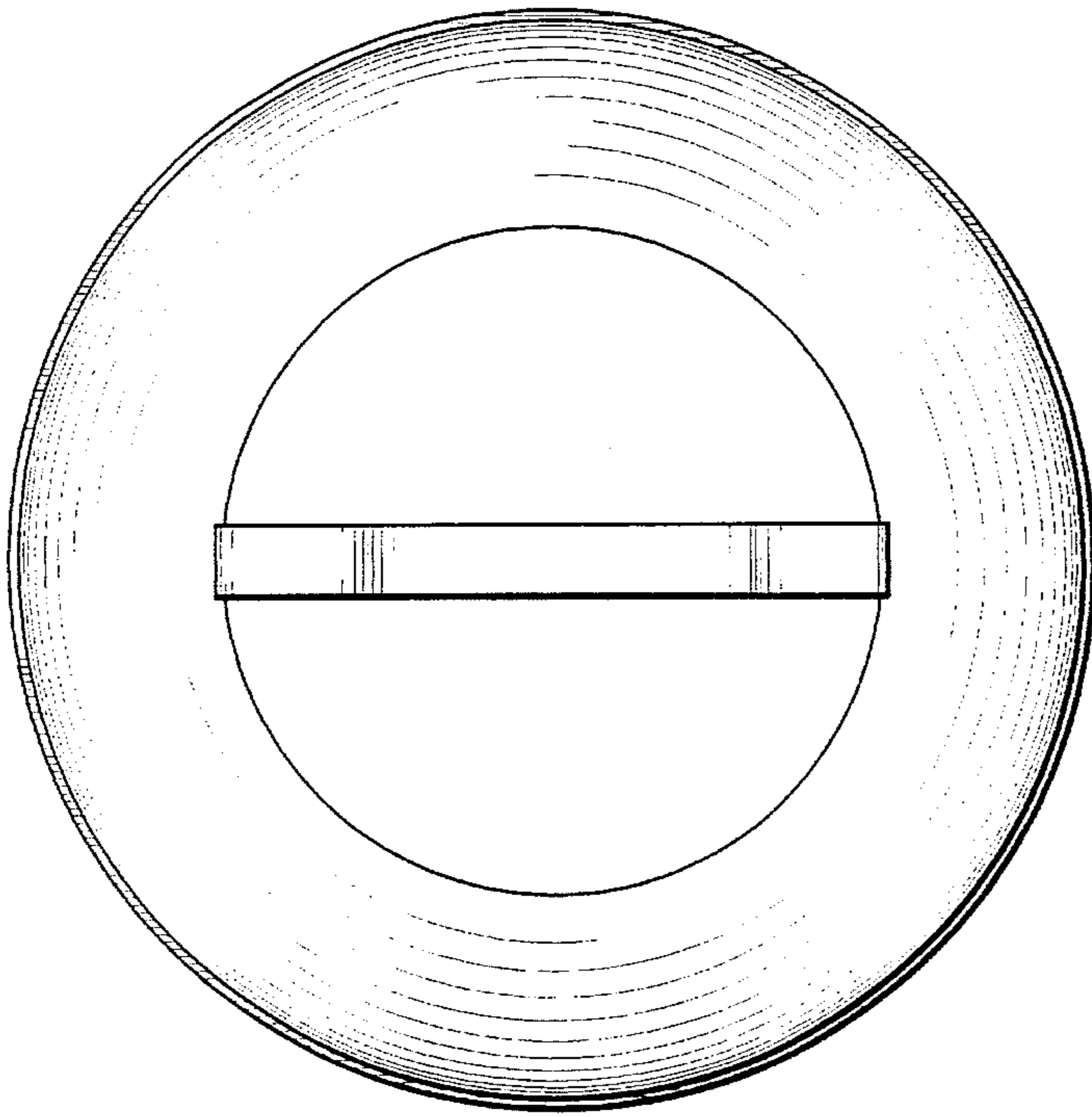

FIG. 6

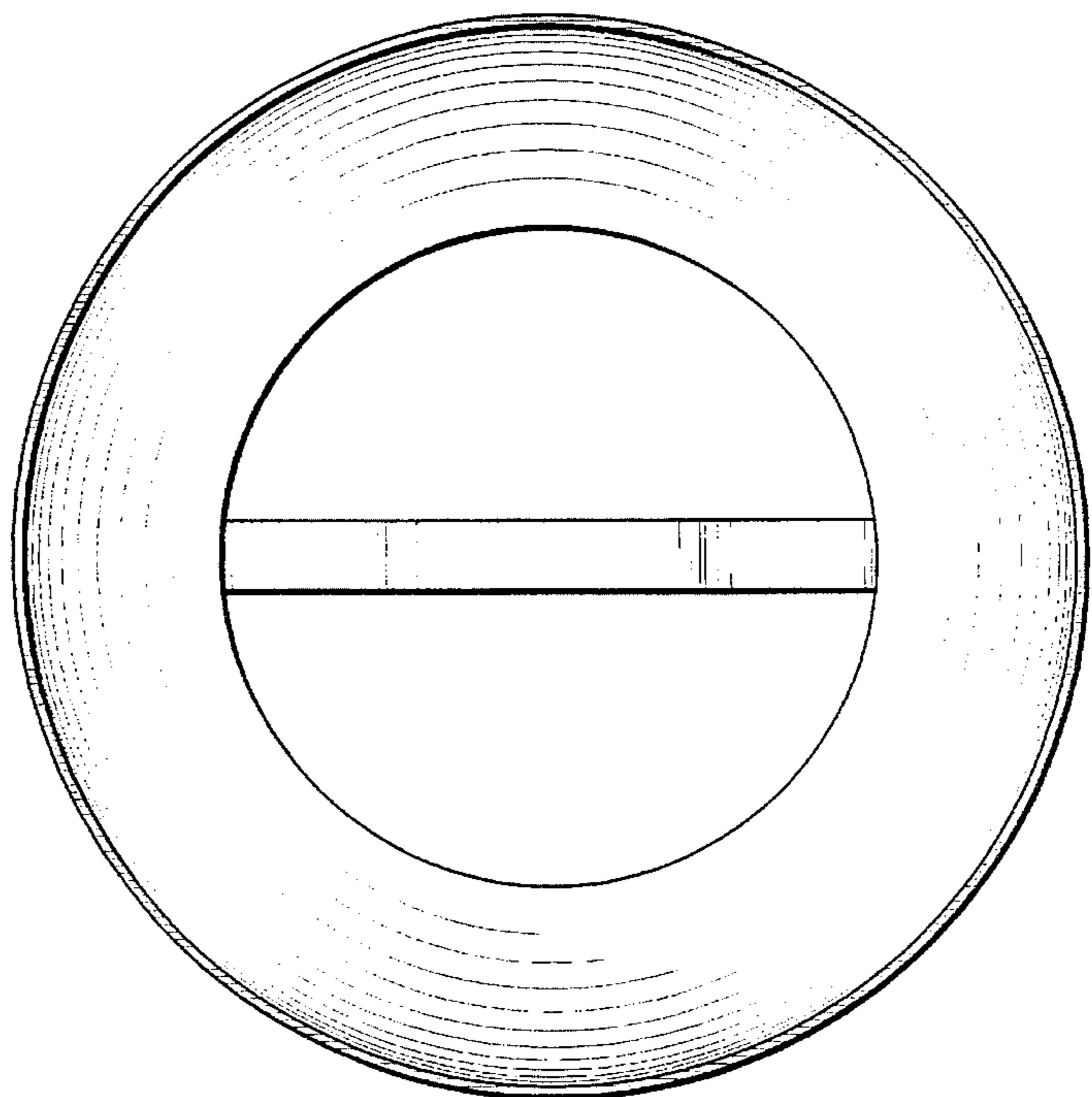

FIG. 7

