



US00D364512S

# United States Patent [19]

[11] Patent Number: Des. 364,512

Stravitz

[45] Date of Patent: \*\*Nov. 28, 1995

## [54] CD STORAGE TOWER

[76] Inventor: David M. Stravitz, 16 Park Ave., Ste. 14A, New York, N.Y. 10016

[\*\*] Term: 14 Years

[21] Appl. No.: 10,304

[22] Filed: Jul. 1, 1993

[52] U.S. Cl. .... D6/407

[58] Field of Search ..... D6/396, 405, 407, D6/626, 629, 630, 462, 466, 467, 468, 477, 478, 479; D14/120, 121; D19/8, 27, 75, 76, 91; 206/387; 211/40, 41, 42

## [56] References Cited

### U.S. PATENT DOCUMENTS

D. 331,166	11/1992	Ohadi	.....	D6/407	X
D. 351,512	10/1994	Thielen	.....	D6/407	
D. 351,528	10/1994	Dardashti	.....	D6/630	
4,819,801	4/1989	Howard	.....	211/40	X
5,195,642	3/1993	Dardashti	.....	211/40	X
5,314,077	5/1994	Theosabrata	.....	211/40	

### FOREIGN PATENT DOCUMENTS

9110569 10/1991 Germany

### OTHER PUBLICATIONS

Home Decorator Collection, "CD Storage Center". Damark; Home Furnishings; p. 55. Jun. 1993. Affordable Brand Furniture; 1993; pp. 1-6. Gusdorf brochure; Model 2452; p. 106 admitted Prior Art. Heartland America brochure; pp. 21; 23; 29; 37; 46 admitted Prior Art.

Primary Examiner—Alan P. Douglas  
Assistant Examiner—S. Snapp  
Attorney, Agent, or Firm—Frishauf, Holtz, Goodman, Langer & Chick

## [57] CLAIM

The ornamental design for a CD storage tower, as shown and described.

## DESCRIPTION

FIG. 1 is a front, left, top perspective view of a CD storage

tower showing my new design;  
 FIG. 2 is a front elevational view thereof;  
 FIG. 3 is a top plan view thereof;  
 FIG. 4 is a right side elevational view thereof, the left side elevational view being a mirror image;  
 FIG. 5 is a rear elevational view thereof;  
 FIG. 6 is a bottom plan view thereof;  
 FIG. 7 is a front, left, top perspective view of a modified embodiment thereof;  
 FIG. 8 is a front elevational view thereof;  
 FIG. 9 is a top plan view thereof;  
 FIG. 10 is a right side elevational view thereof, the left side elevational view being a mirror image;  
 FIG. 11 is a rear elevational view thereof;  
 FIG. 12 is a bottom plan view thereof;  
 FIG. 13 is a sectional view thereof taken along the line 13—13 in FIG. 8;  
 FIG. 14 is a front, left, top perspective view of a further modified embodiment thereof;  
 FIG. 15 is a front elevational view thereof, the rear elevational view being identical;  
 FIG. 16 is a top plan view thereof;  
 FIG. 17 is a right side elevational view thereof, the left side elevational view being identical;  
 FIG. 18 is a bottom plan view thereof;  
 FIG. 19 is a sectional view thereof taken along the line 19—19 in FIG. 15;  
 FIG. 20 is a front, left, top perspective view of another modified embodiment thereof;  
 FIG. 21 is a front elevational view thereof;  
 FIG. 22 is a top plan view thereof;  
 FIG. 23 is a right side elevational view thereof, the left side elevational view being a mirror image;  
 FIG. 24 is a rear elevational view thereof; and,  
 FIG. 25 is a bottom plan view thereof.

The broken line showing of compact discs in FIGS. 1, 7, 14 and 20 is for illustrative purposes only and forms no part of the claimed design.

1 Claim, 11 Drawing Sheets

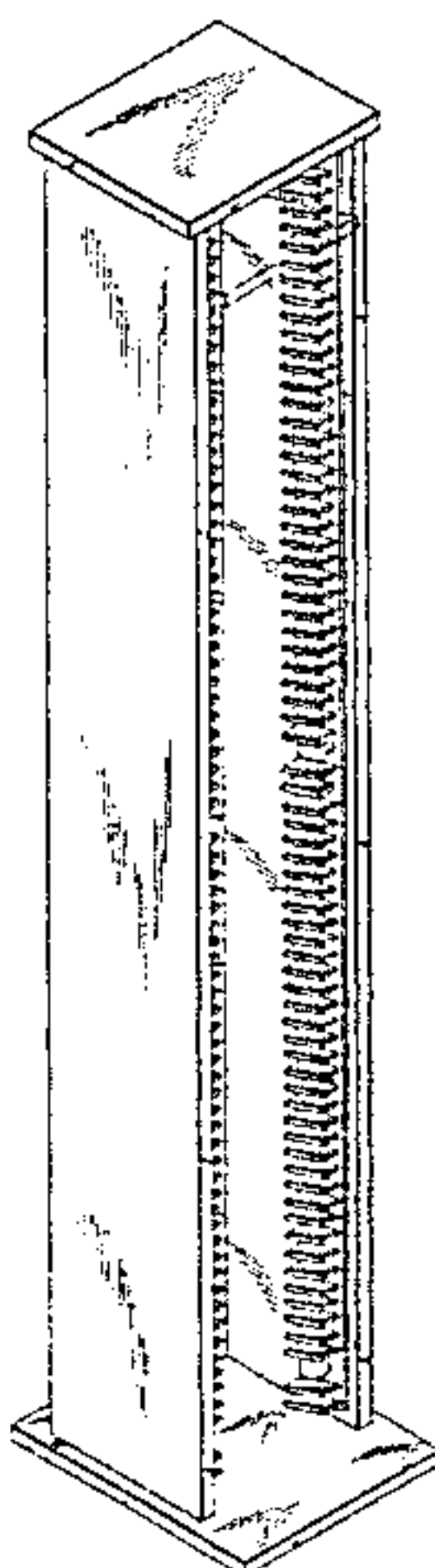

FIG. 1

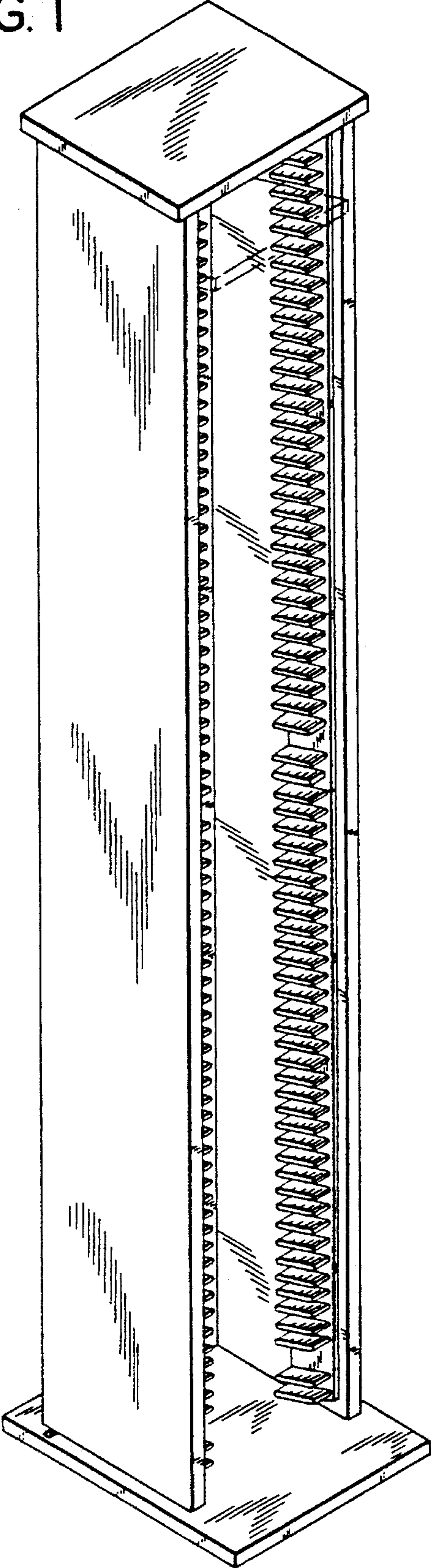

FIG. 2

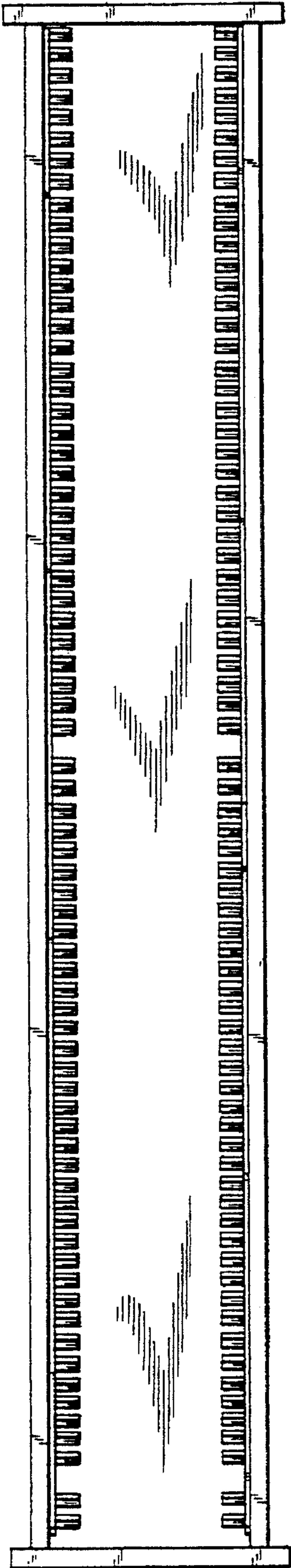

FIG. 4

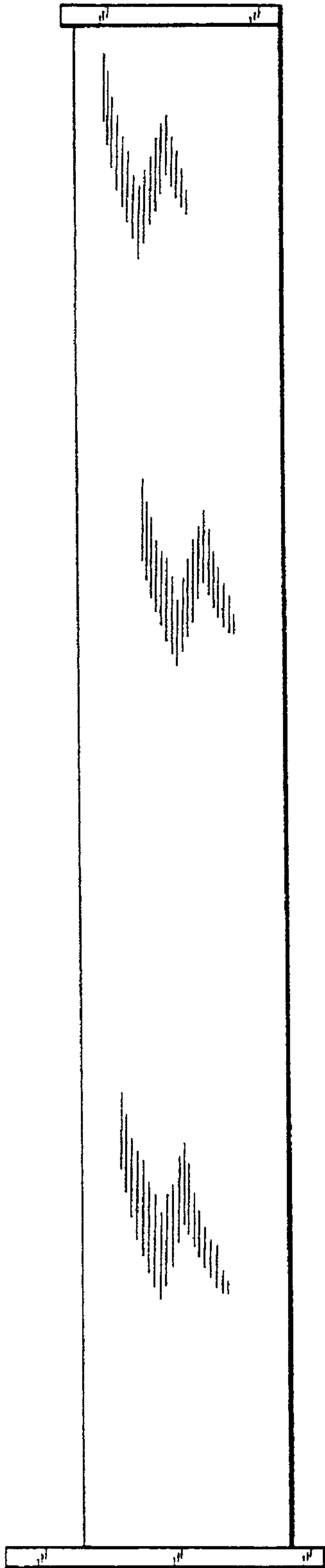

FIG. 5

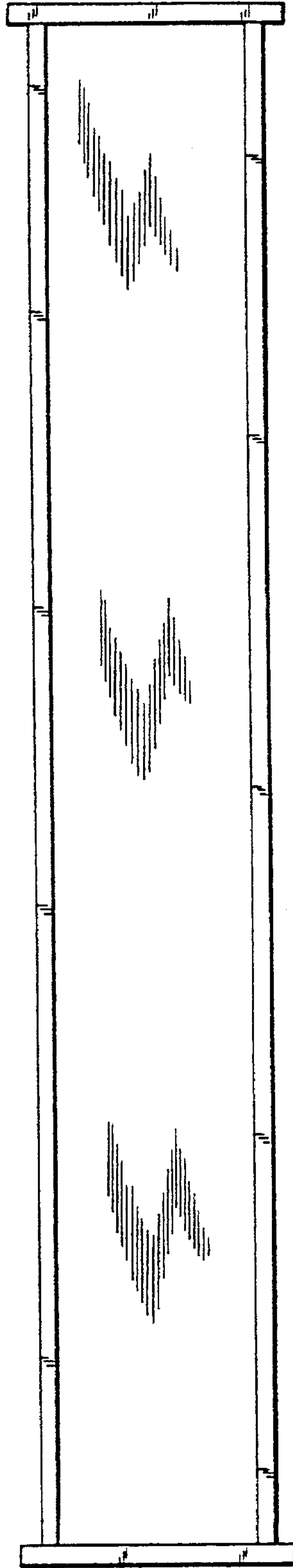

FIG. 3

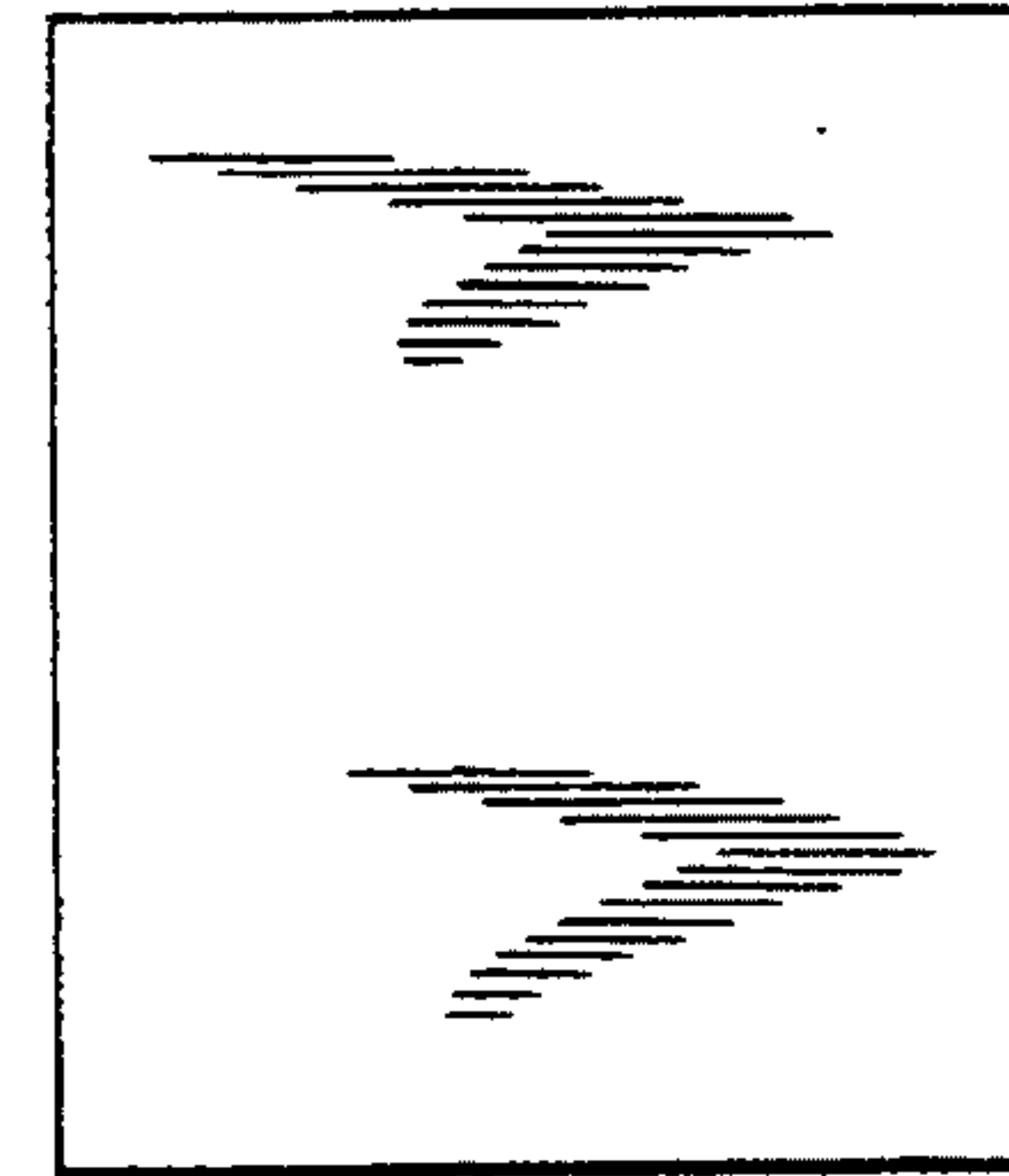
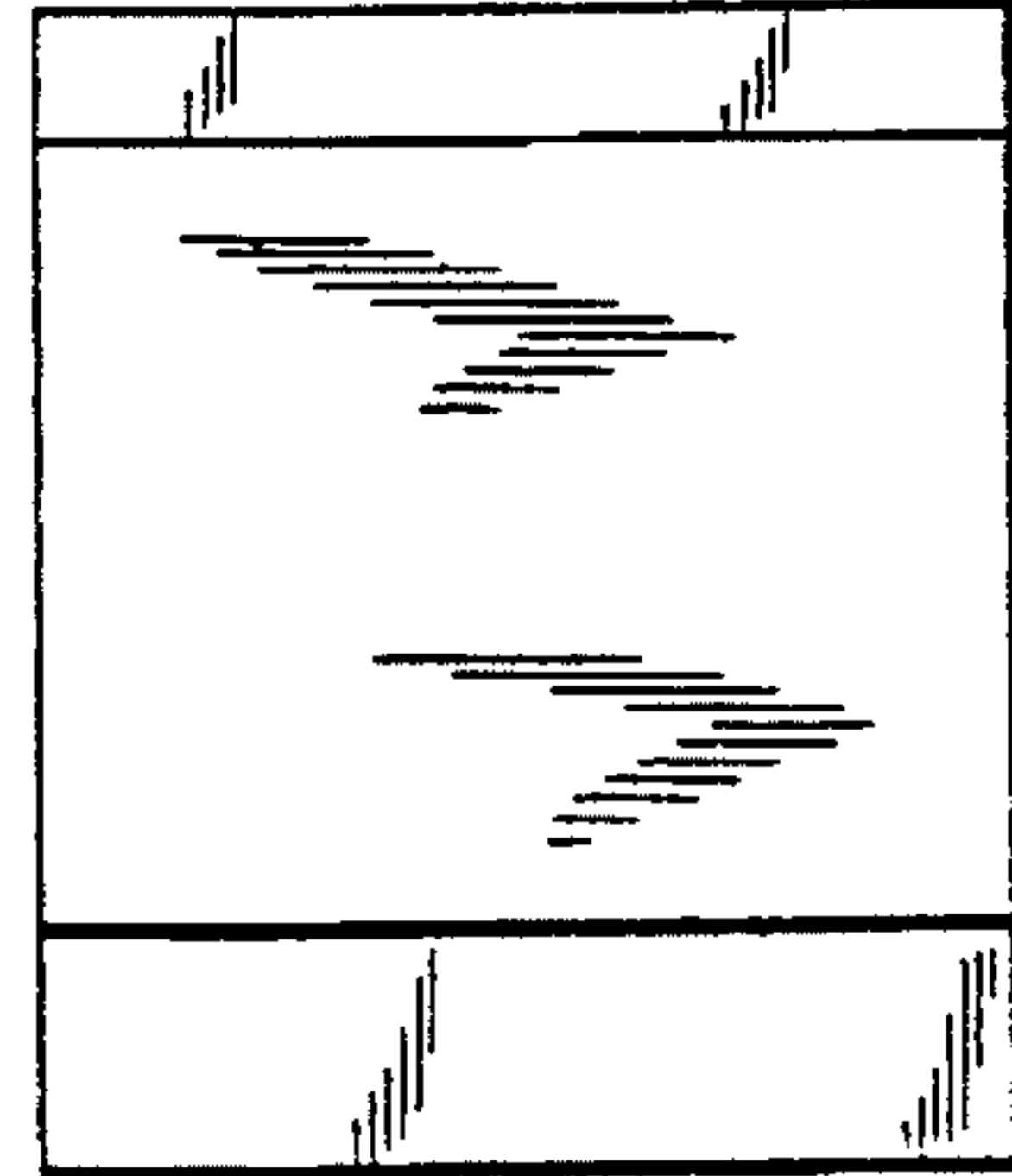

FIG. 6



FIG. 7

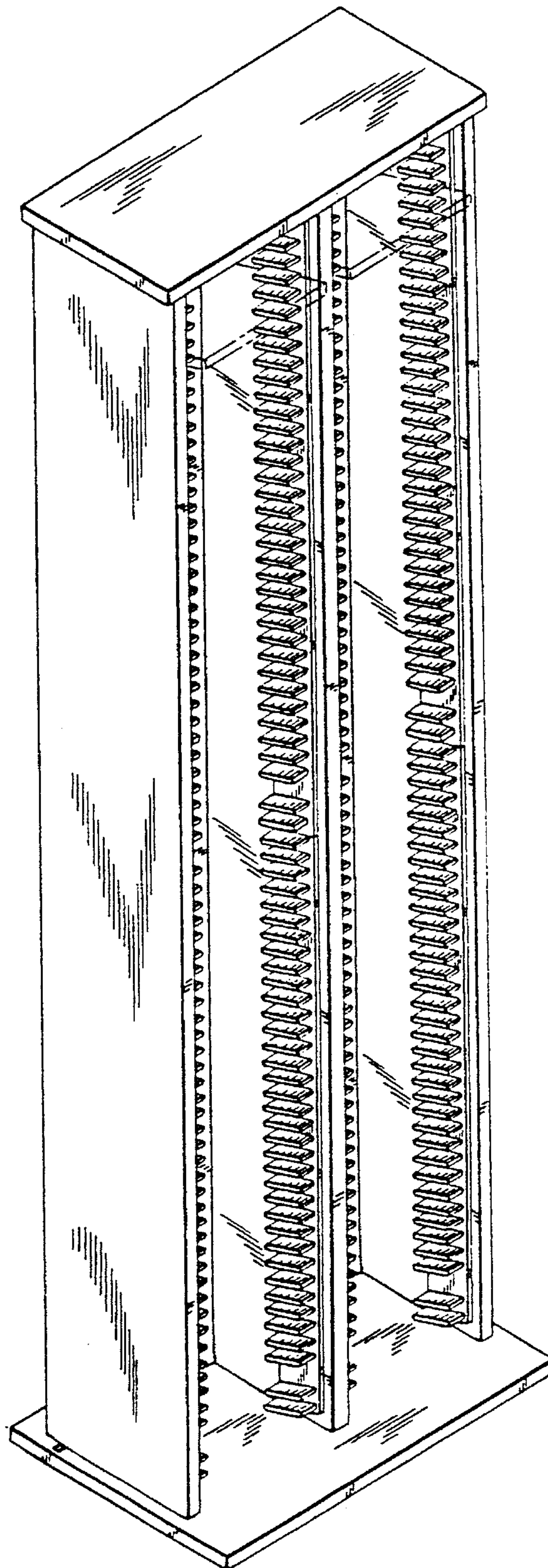

FIG. 8

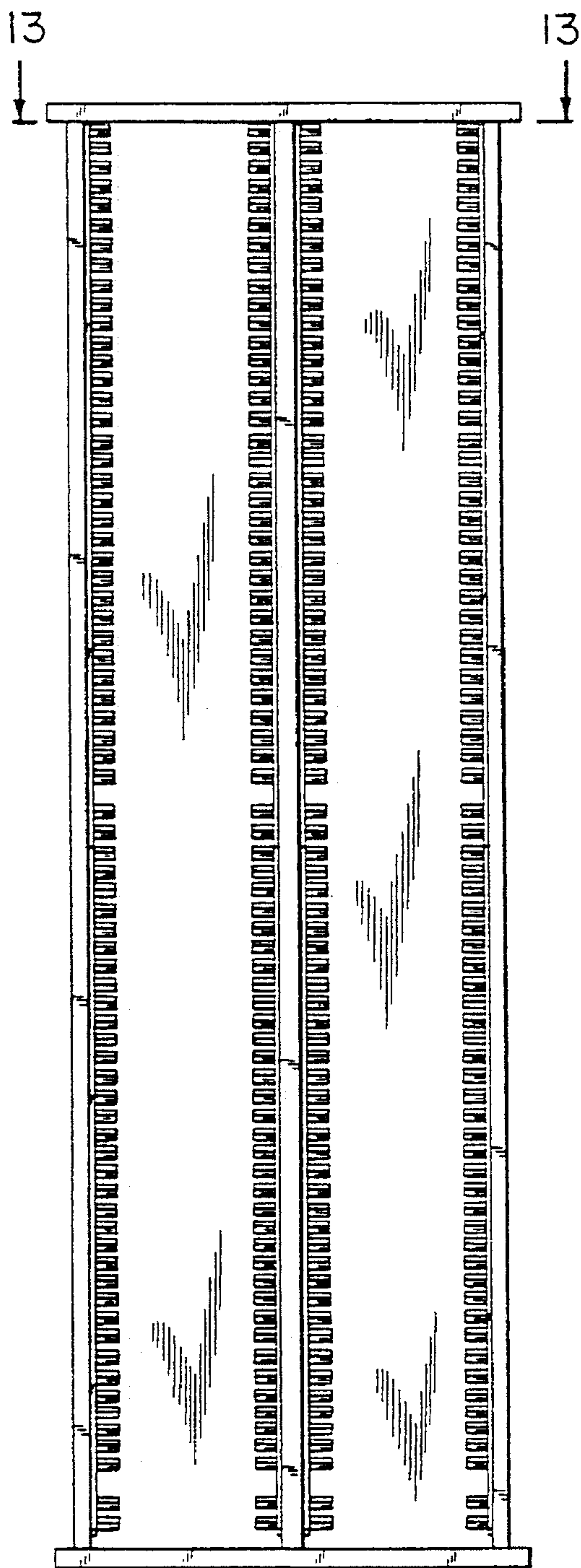

FIG. 9

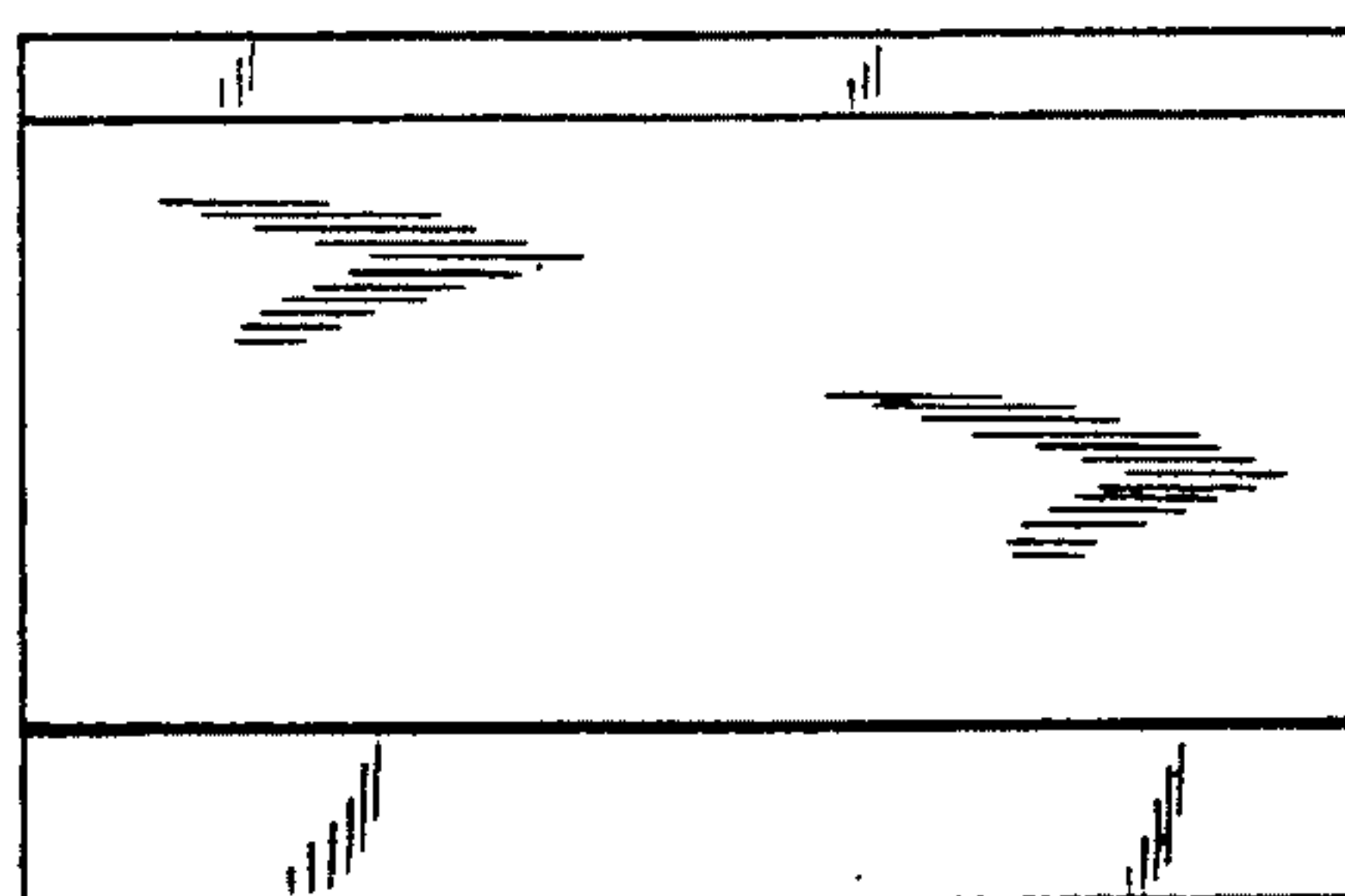

FIG. 12

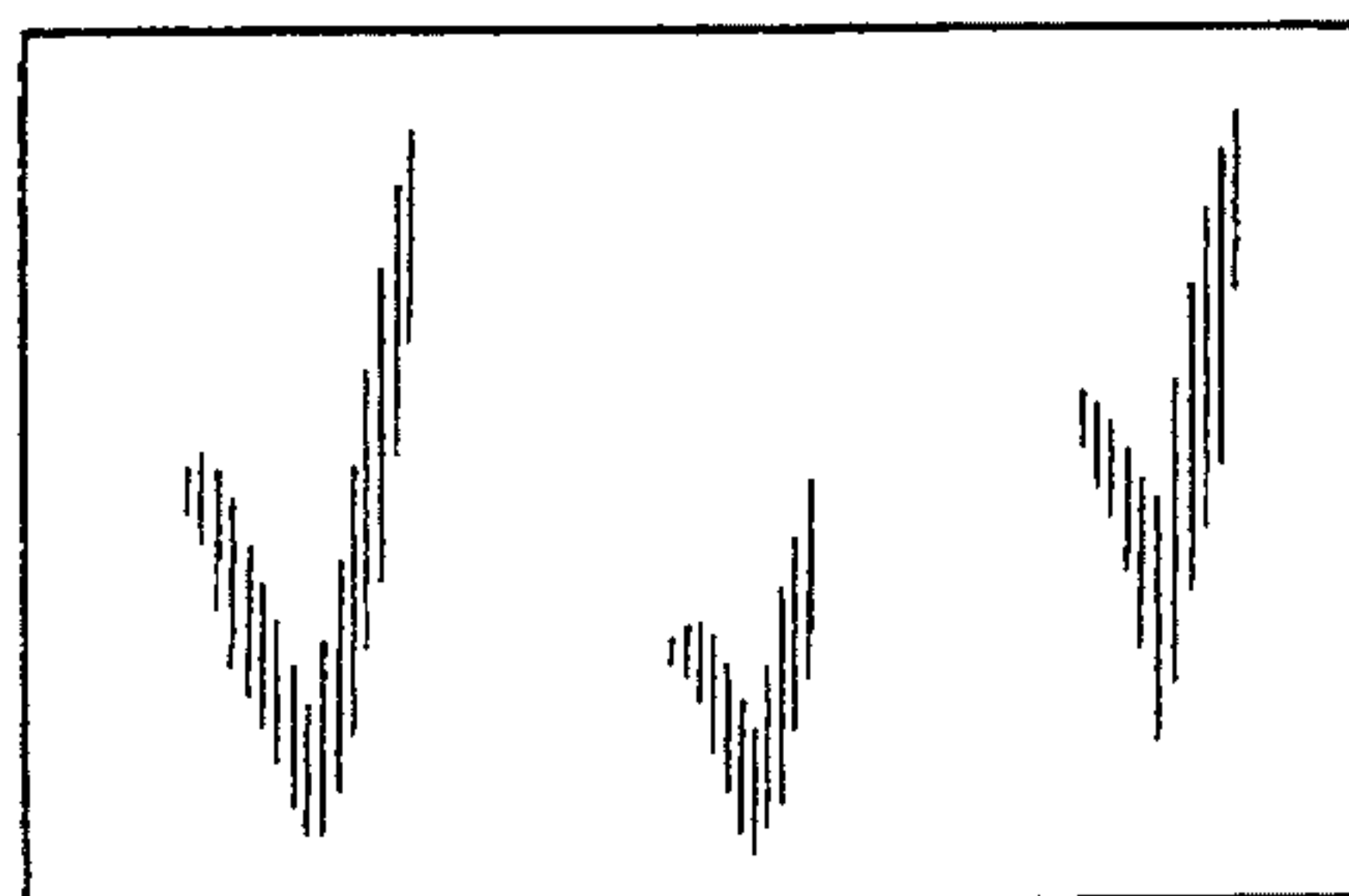

FIG. 13

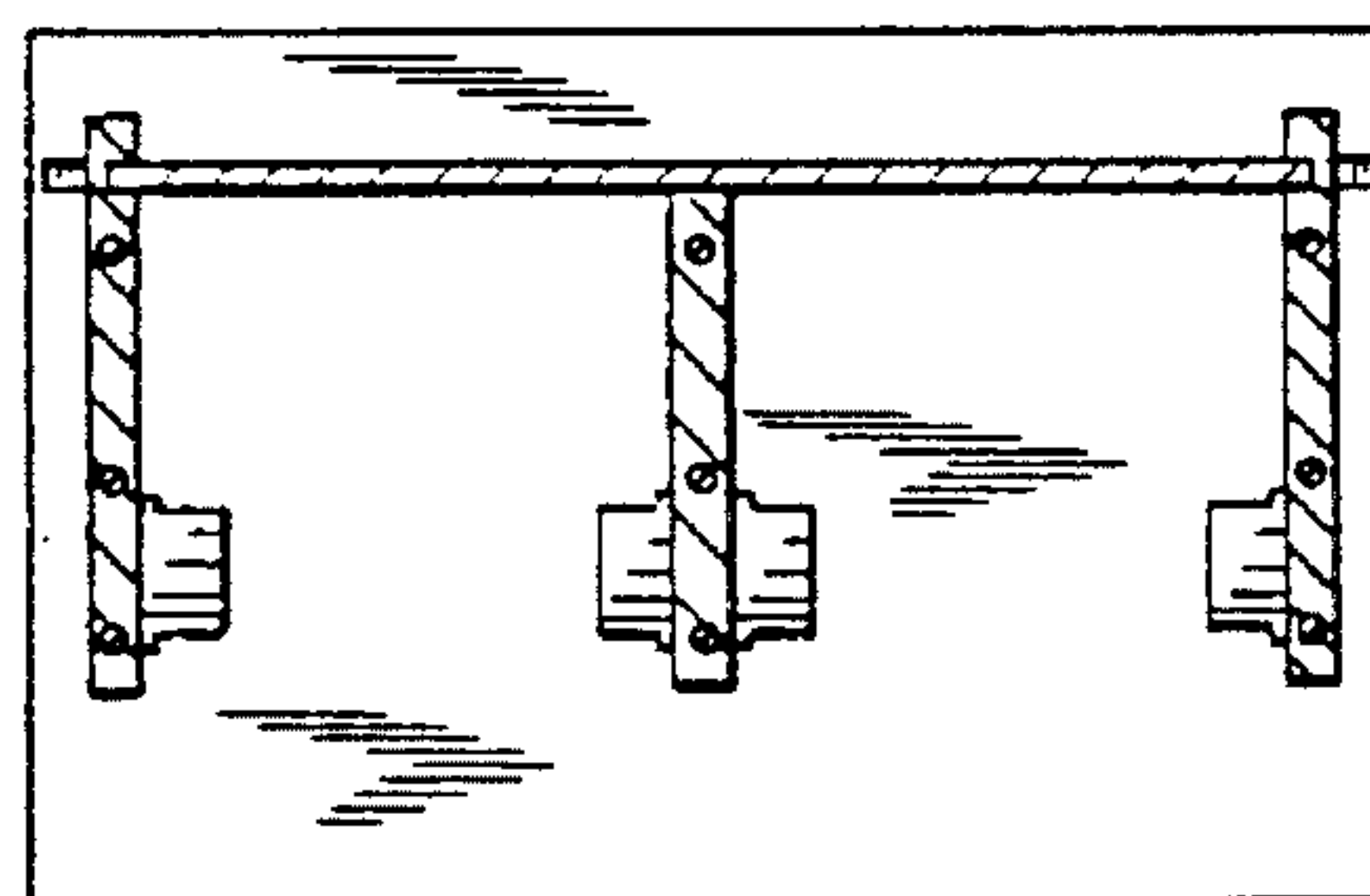

FIG. 10

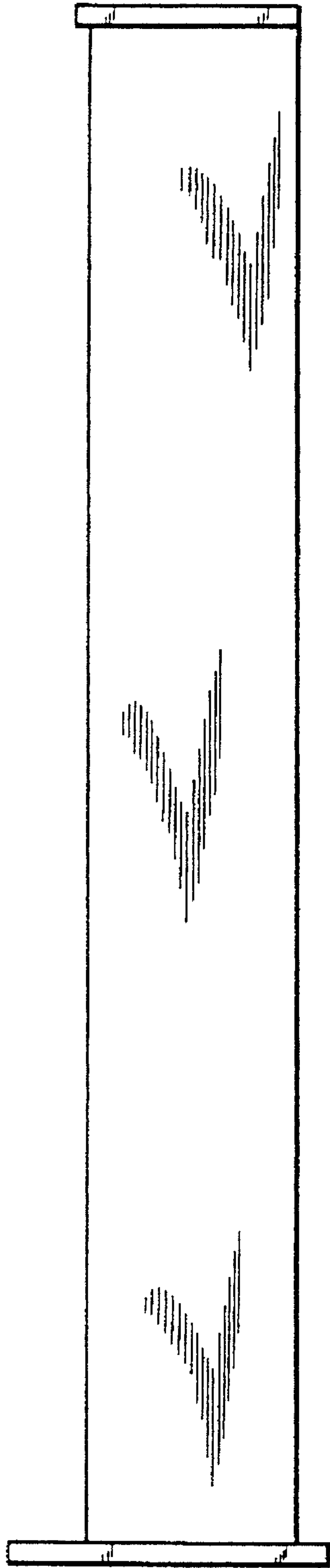
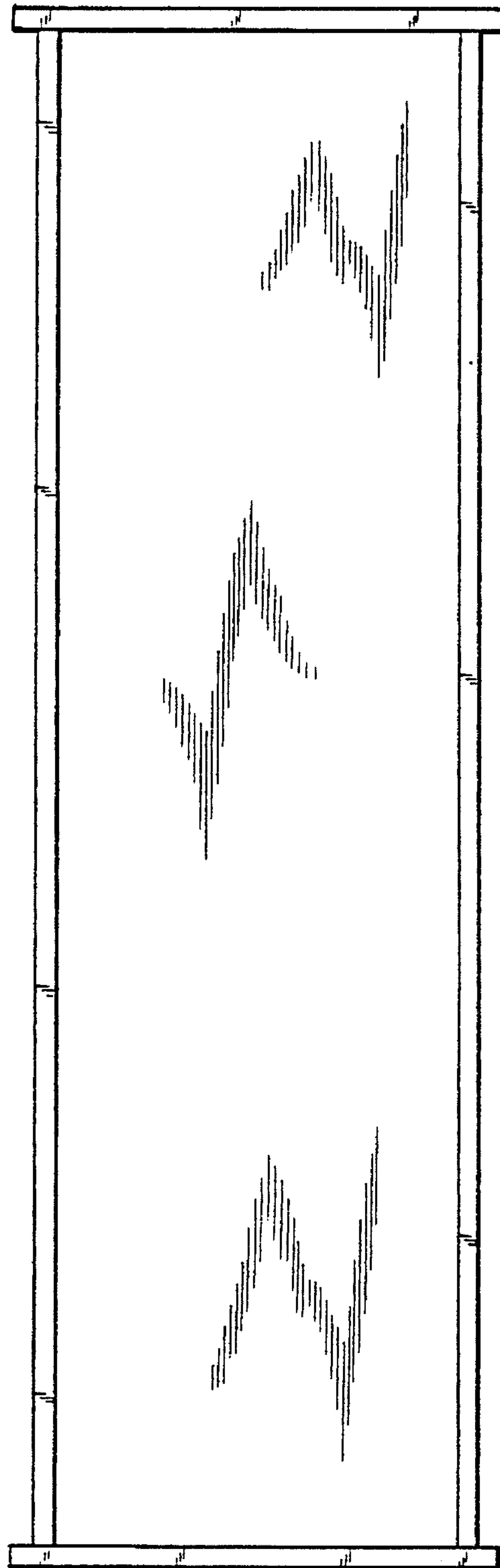

FIG. 11



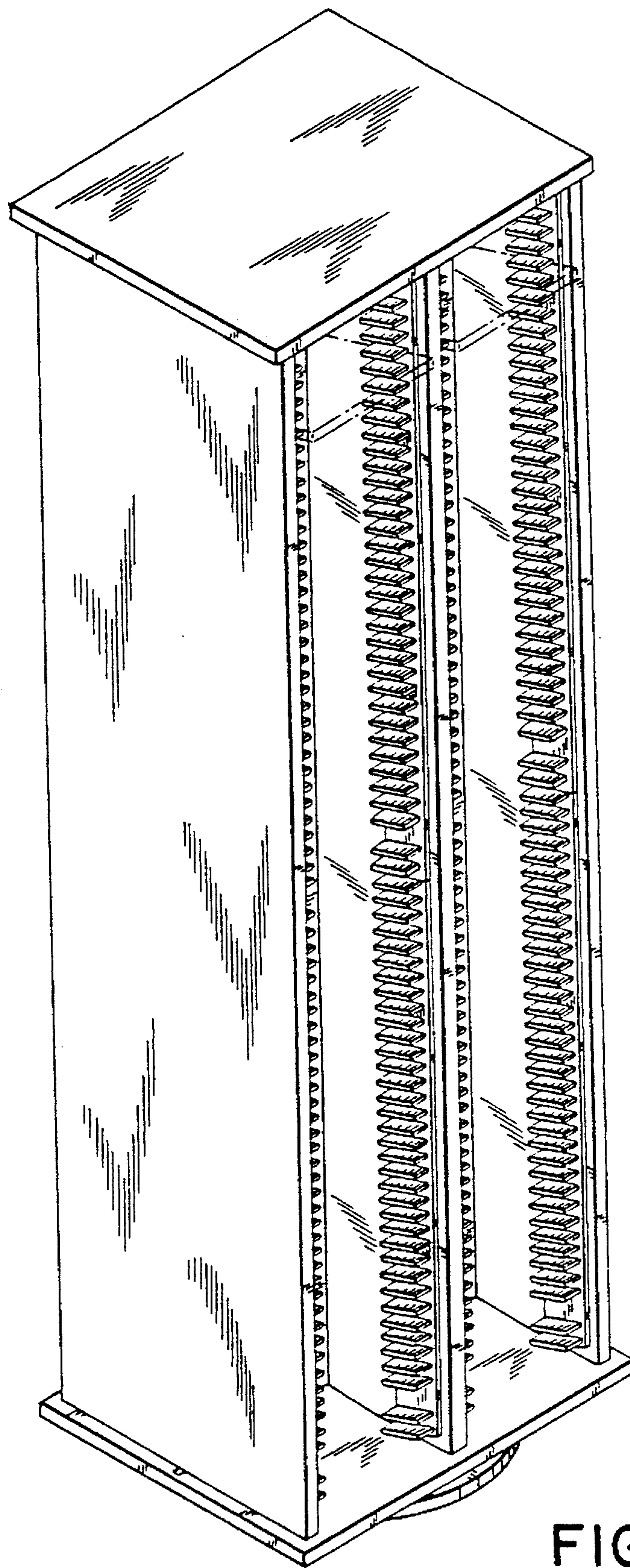

FIG. 14



FIG. 15

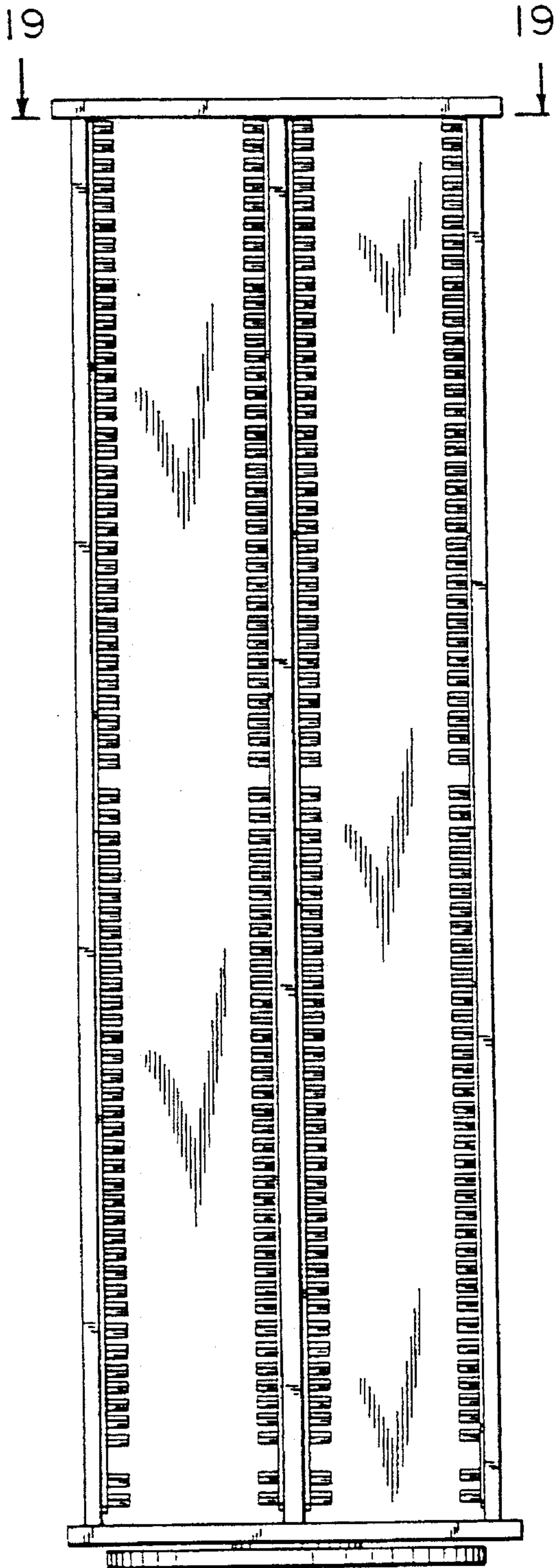

FIG. 16

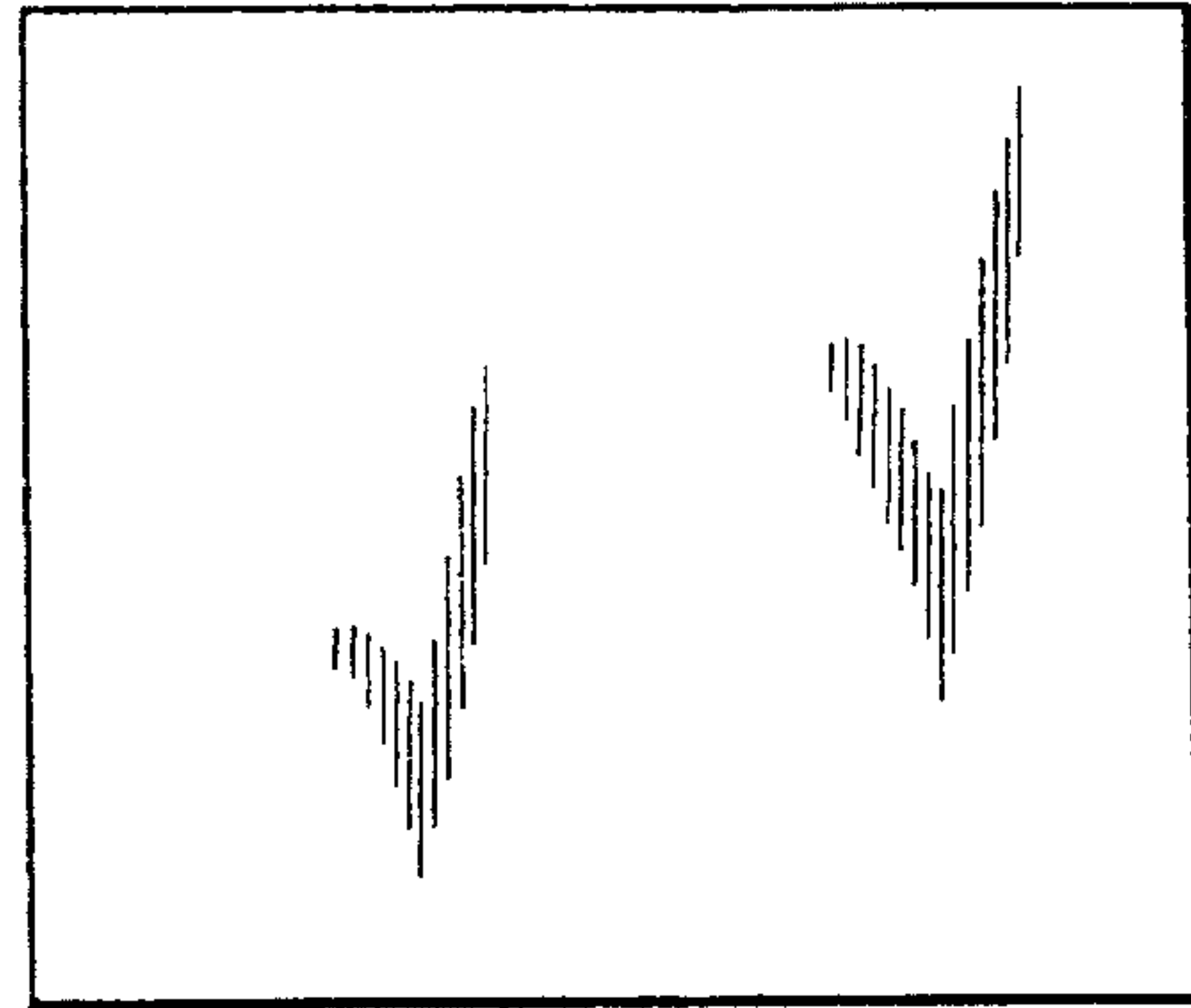

FIG. 18

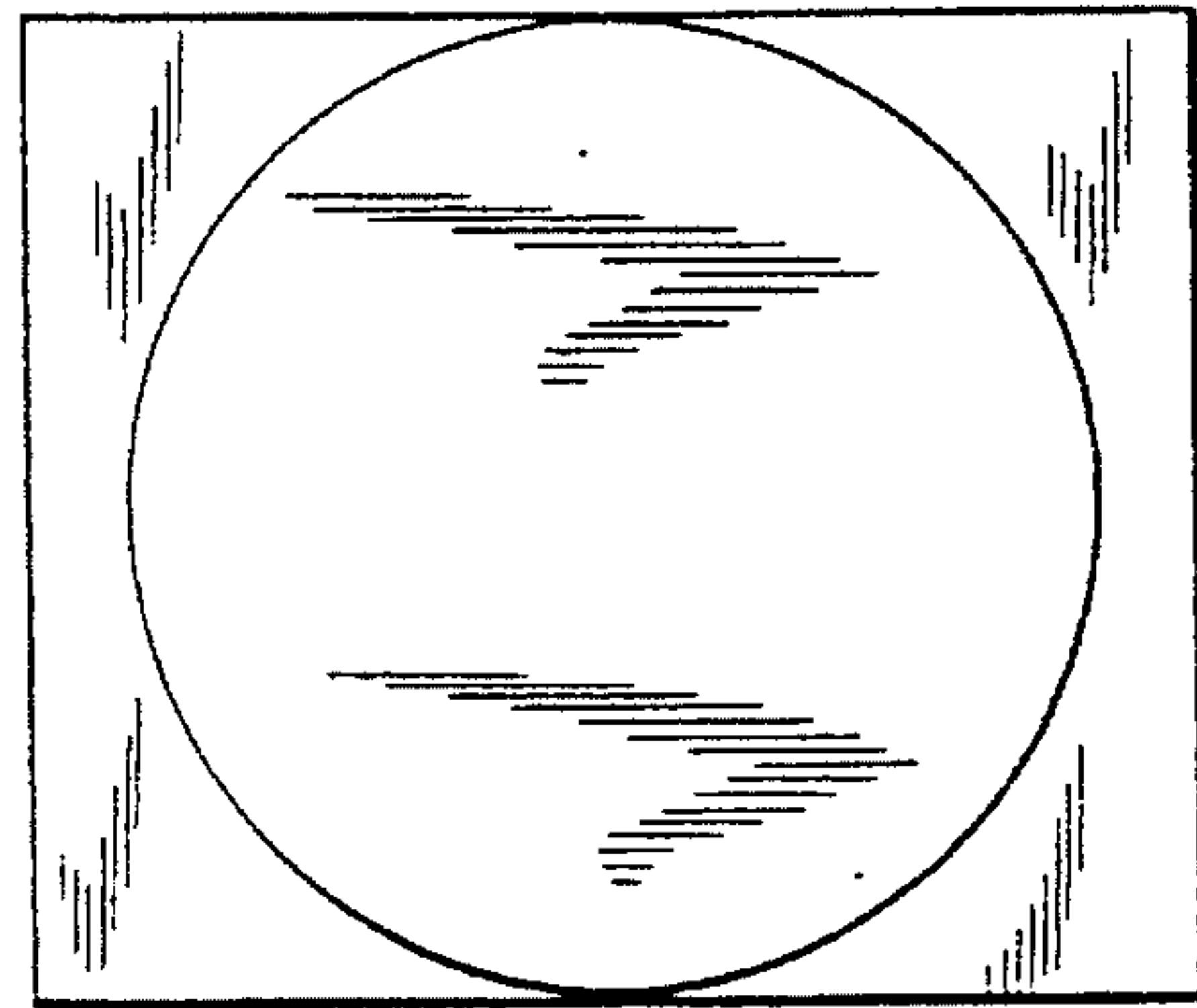

FIG. 19

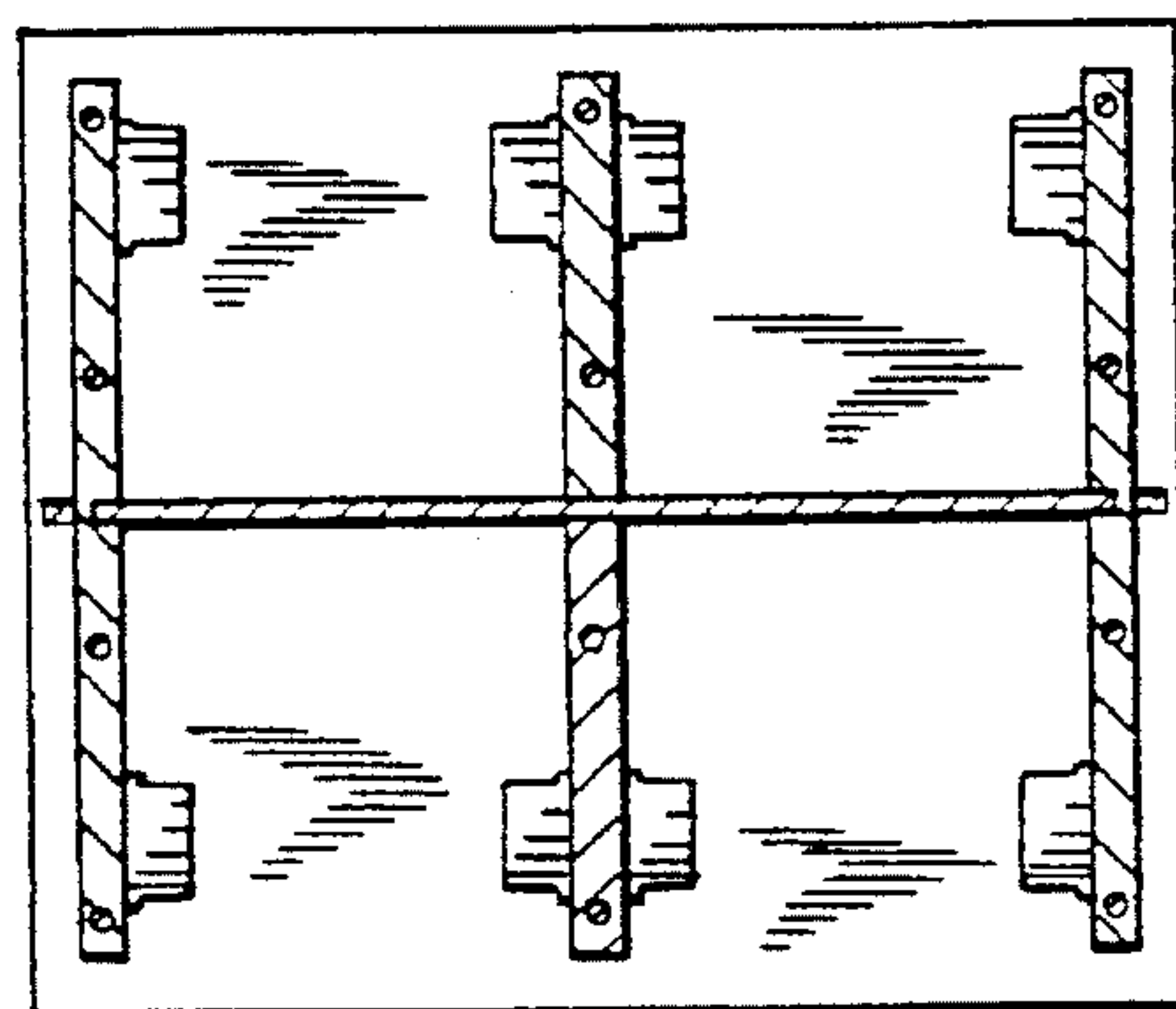



FIG. 17

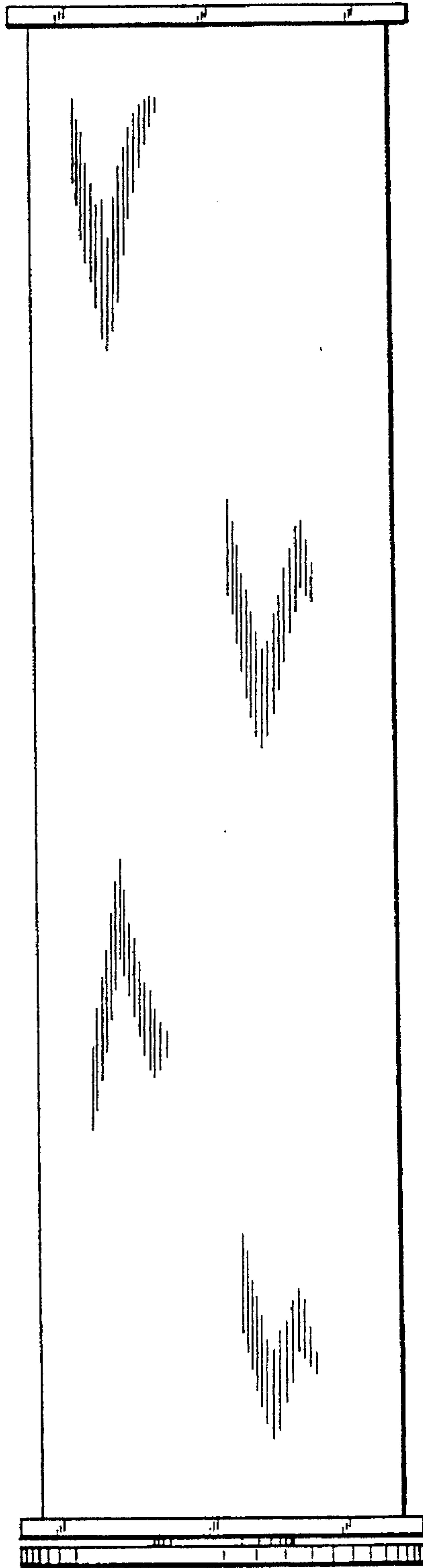

FIG. 20

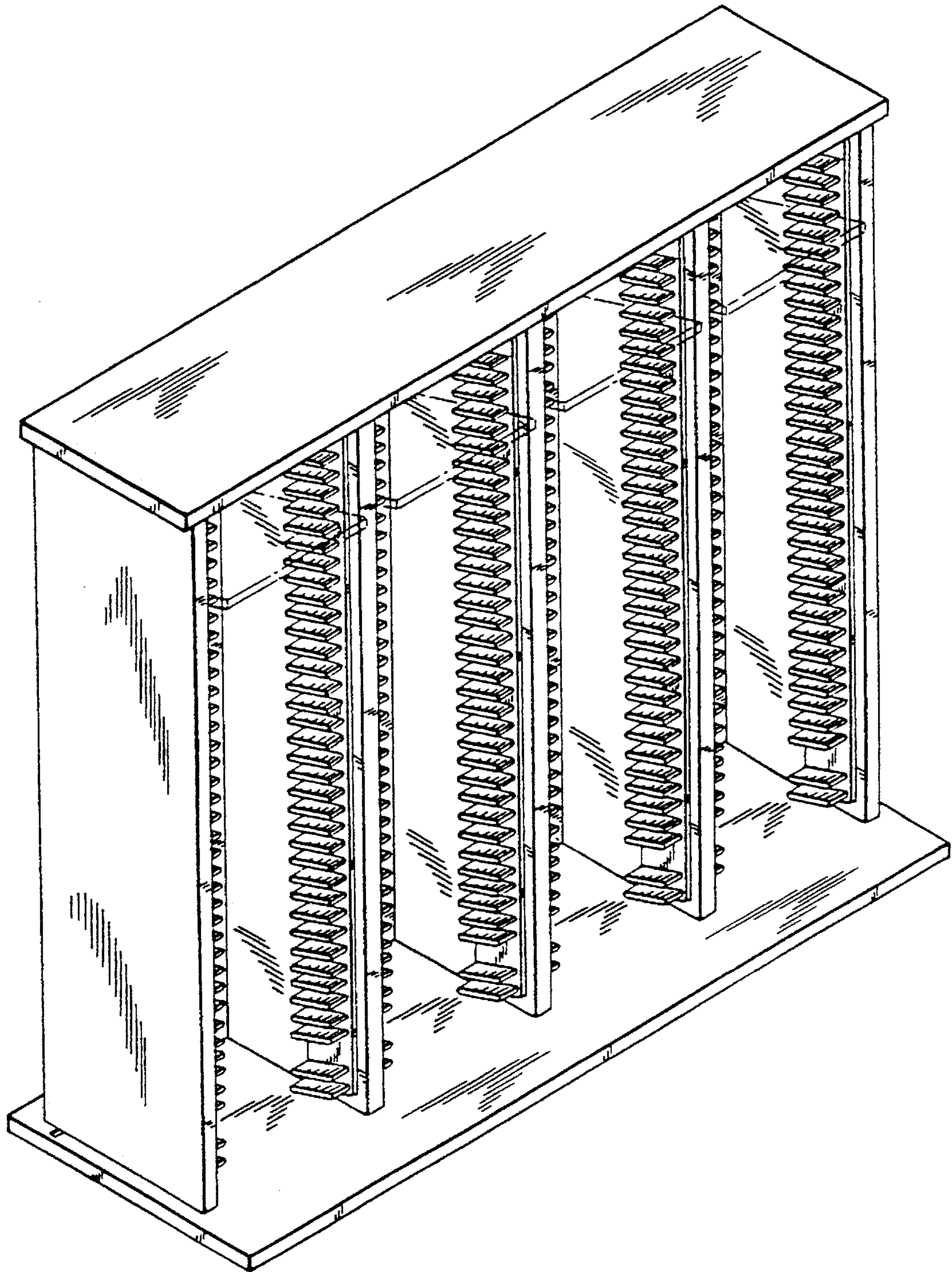

FIG. 22

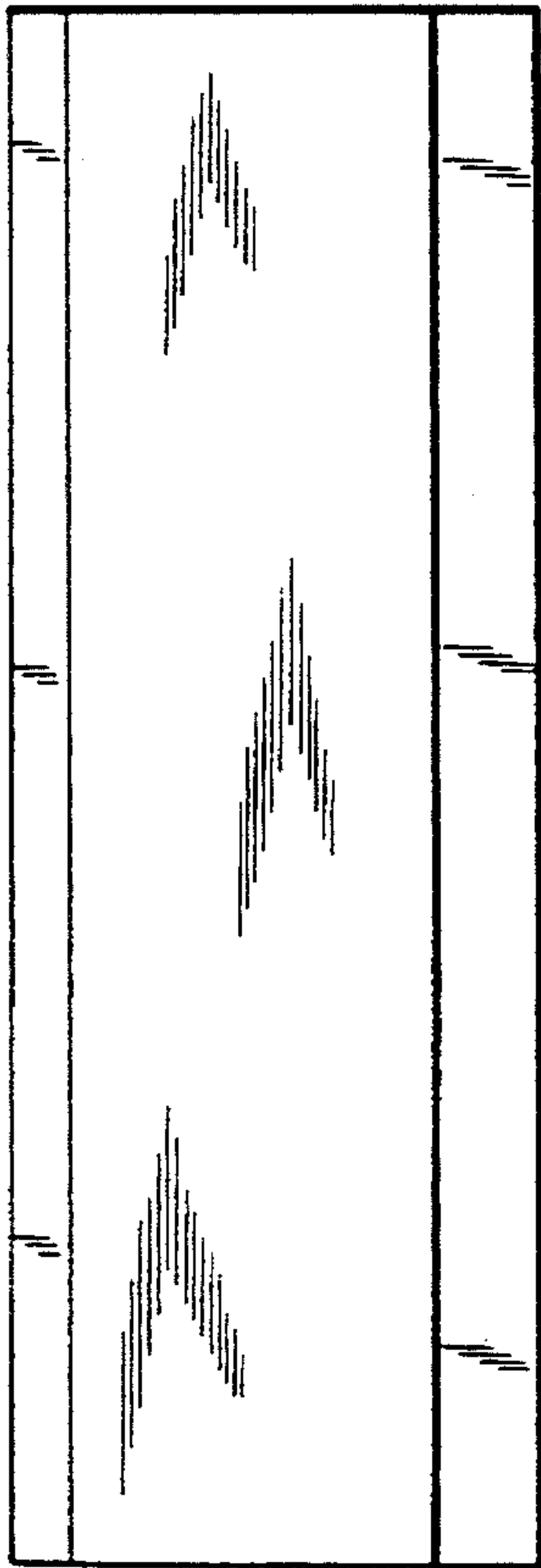
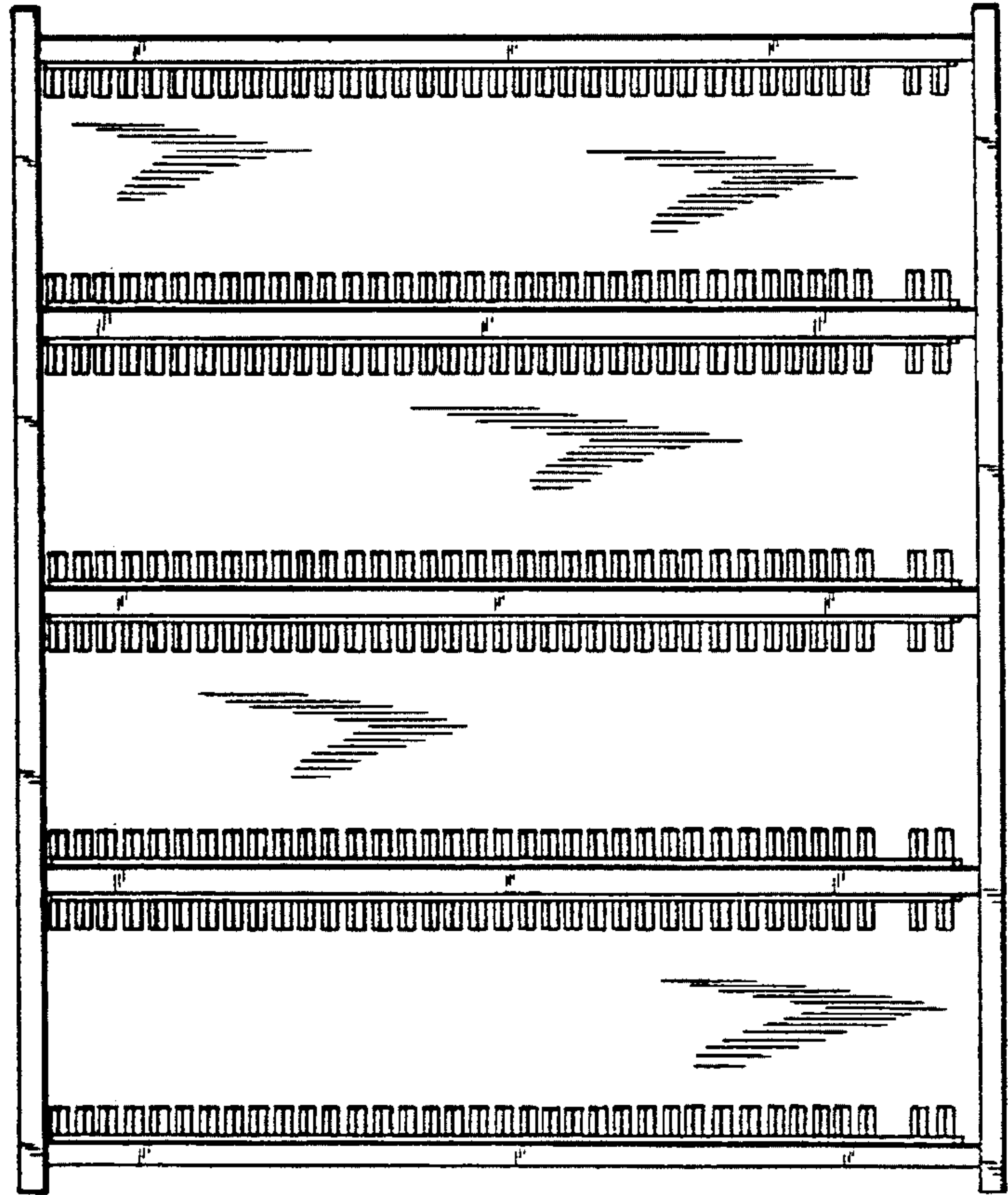

FIG. 21





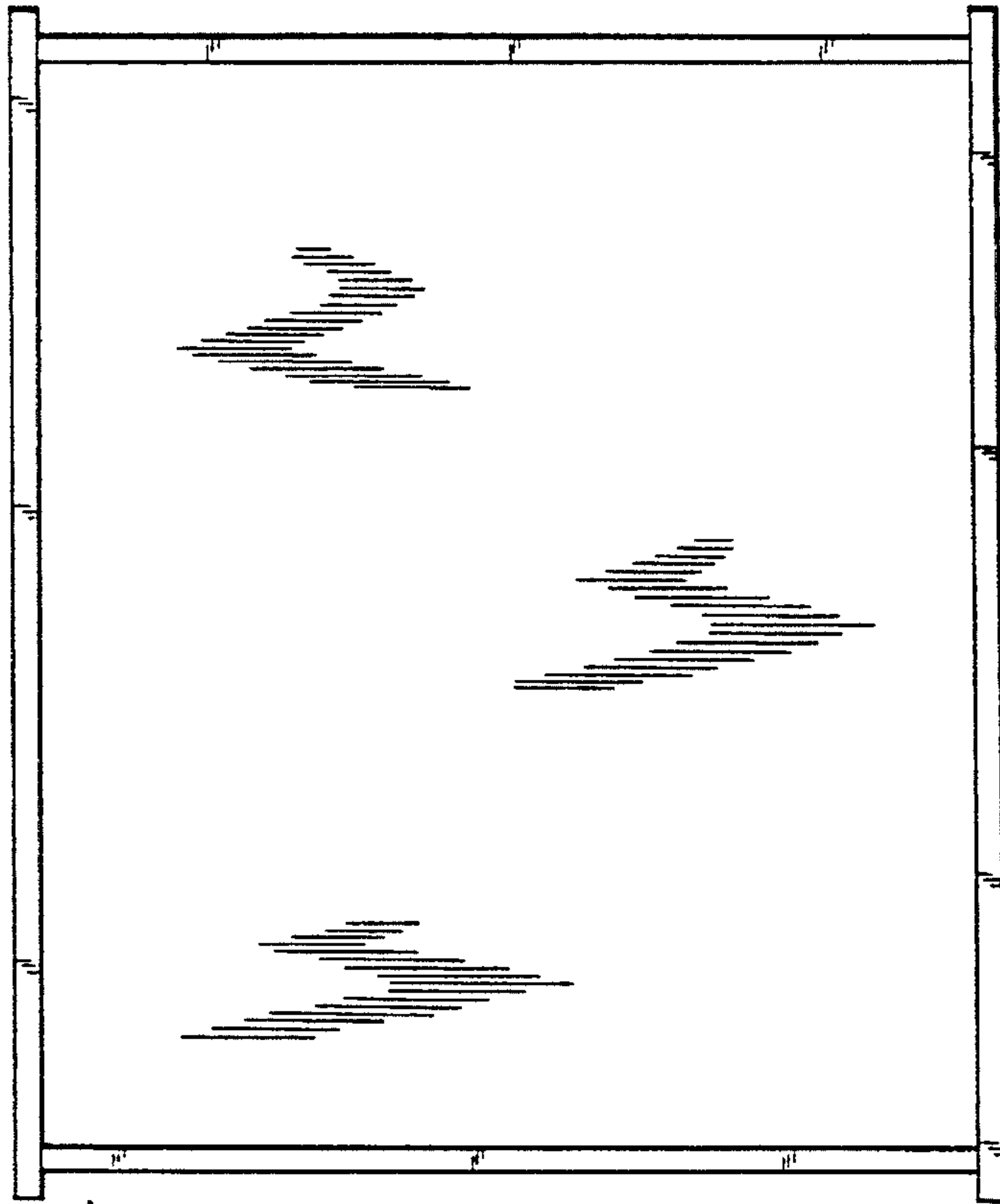

FIG. 24

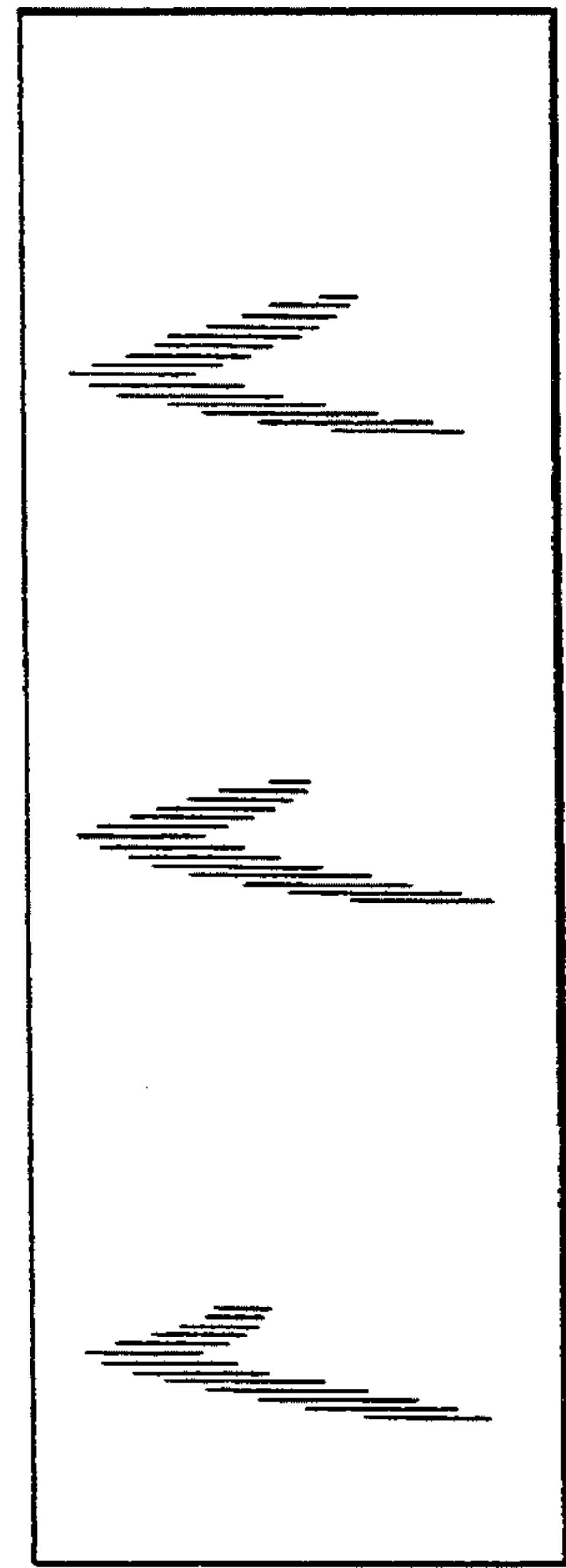

FIG. 25

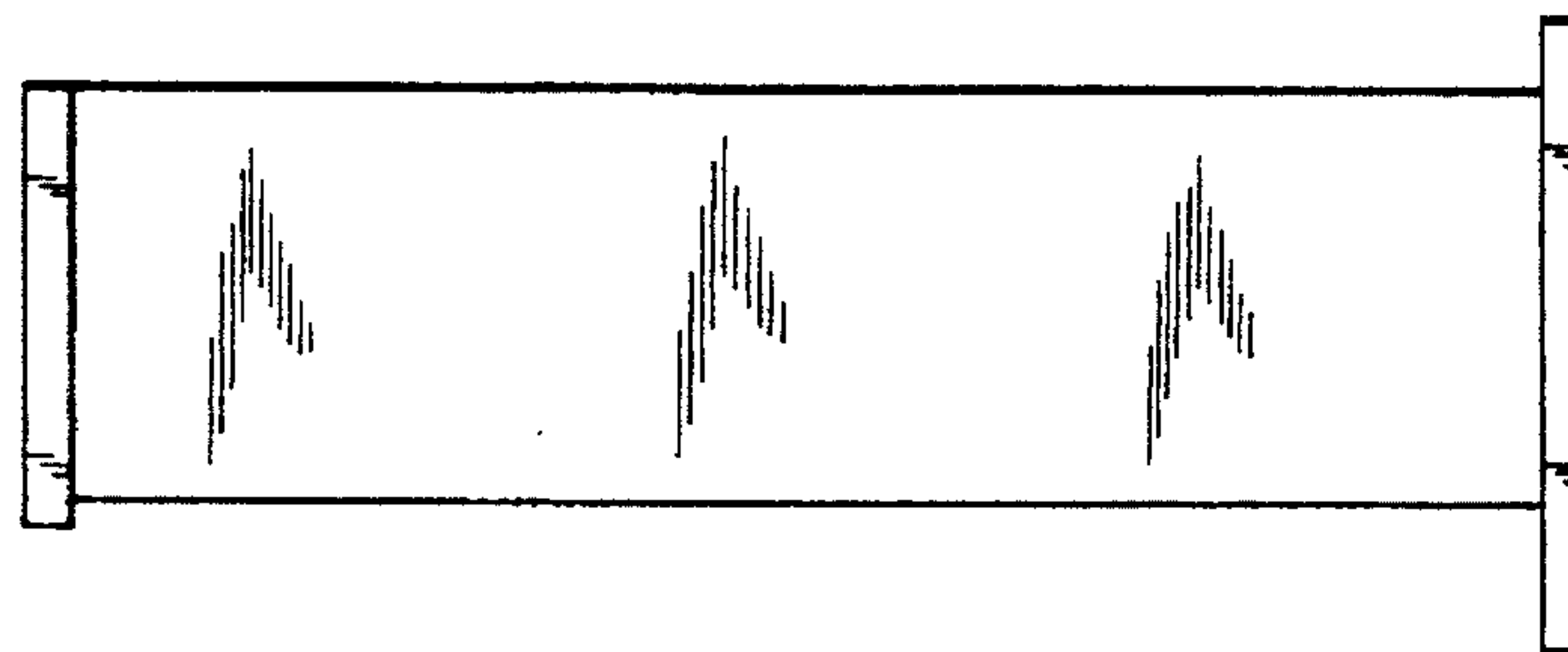

FIG. 23