



US00D364477S

United States Patent [19] Ryder

[11] Patent Number: **Des. 364,477**

[45] Date of Patent: ****Nov. 21, 1995**

[54] SANDBAG LAMP

[76] Inventor: **Charles S. Ryder**, 34 Baughman Ct.,
Battle Creek, Mich. 49017

[**] Term: **14 Years**

[21] Appl. No.: **28,179**

[22] Filed: **Sep. 8, 1994**

[52] U.S. Cl. **D26/60; D26/62**

[58] Field of Search **D26/60-66; 362/131,
362/191, 269, 274, 275, 285, 413, 418,
419, 427, 396**

References Cited

U.S. PATENT DOCUMENTS

D. 281,820	12/1985	Oba et al. .	
D. 293,029	12/1987	Shwisha	D26/60
D. 310,729	9/1990	Stearns .	
D. 322,684	12/1991	Ping .	
3,857,028	12/1974	Olsen .	
4,079,242	3/1978	Seibel .	
4,692,850	9/1987	Le Doux	362/427 X

FOREIGN PATENT DOCUMENTS

271148 5/1927 United Kingdom 362/269

OTHER PUBLICATIONS

Hong Kong Enterprise, Nov. 1984, p. 158, Clamp-on-Lamp
CL28-16.

Primary Examiner—Susan J. Lucas

[57] CLAIM

The ornamental design for the sandbag lamp, as shown and
described.

DESCRIPTION

FIG. 1 is a front elevational view of the sandbag lamp
showing my new design;
FIG. 2 is a rear elevational view thereof;
FIG. 3 is a left side elevational view thereof;
FIG. 4 is a right side elevational view thereof;
FIG. 5 is a top plan view thereof;
FIG. 6 is a bottom plan view thereof; and,
FIG. 7 is a reduced front elevational view showing a use
thereof, the broken line showing of a portion of a sofa for
illustrative purposes only and forming no part of the claimed
design.

1 Claim, 4 Drawing Sheets

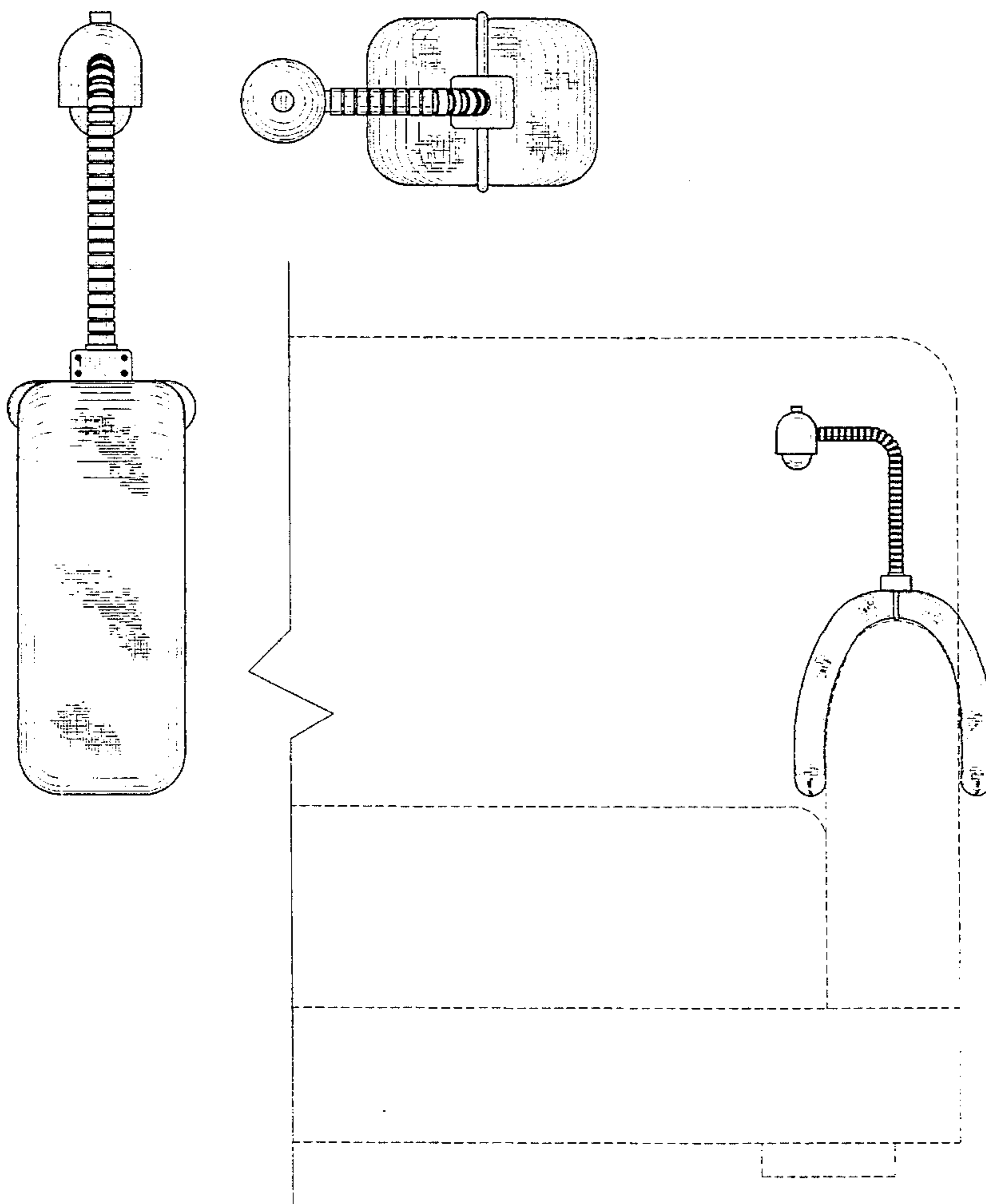

FIG. 1

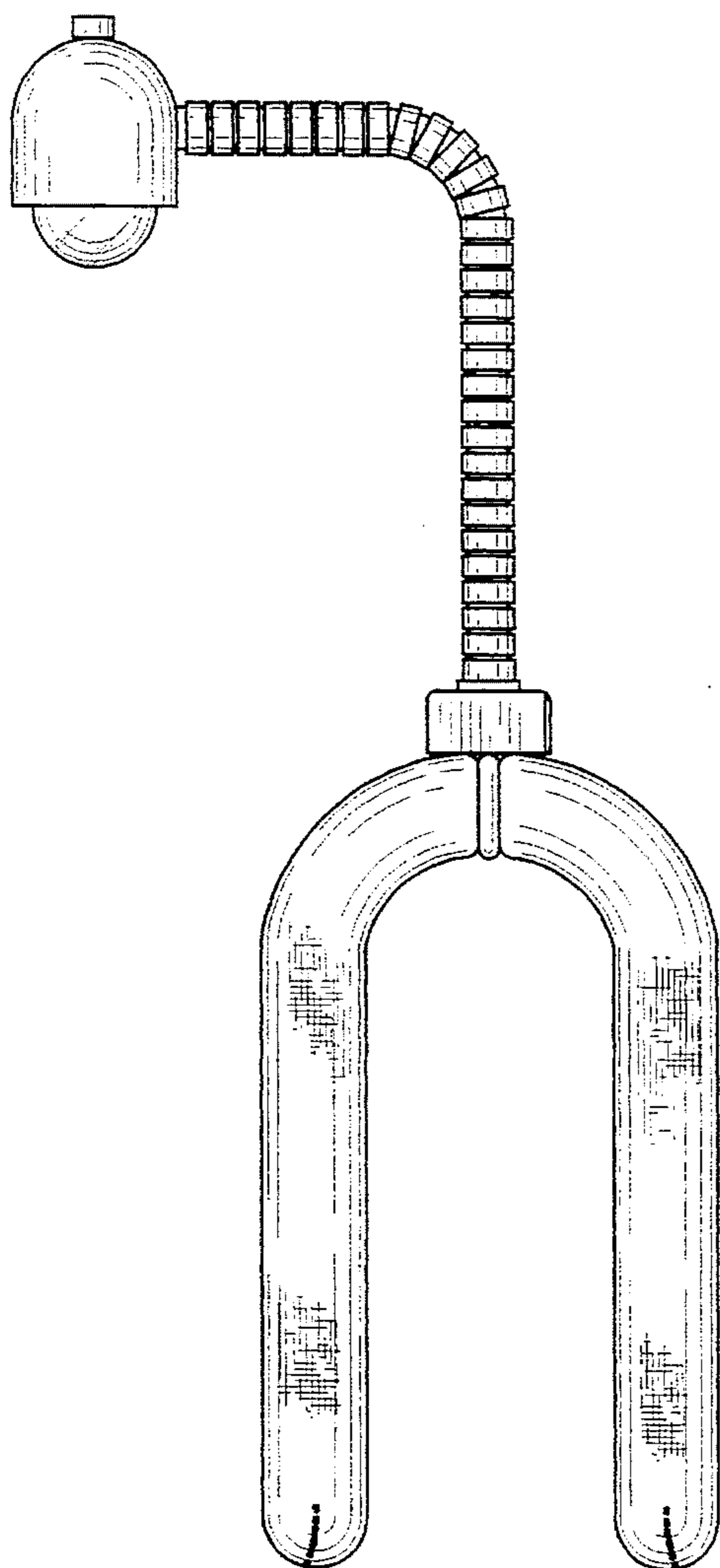

FIG. 2

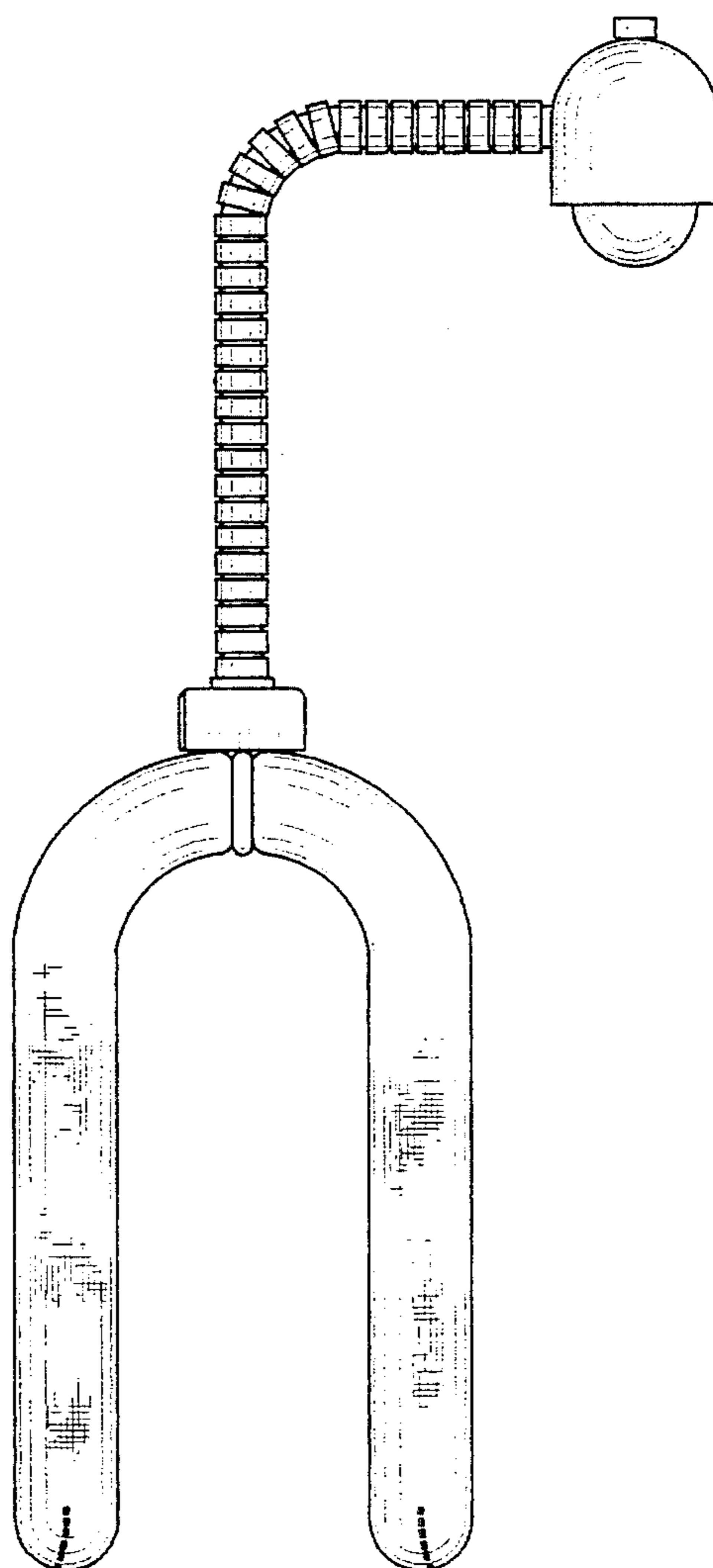

FIG. 3

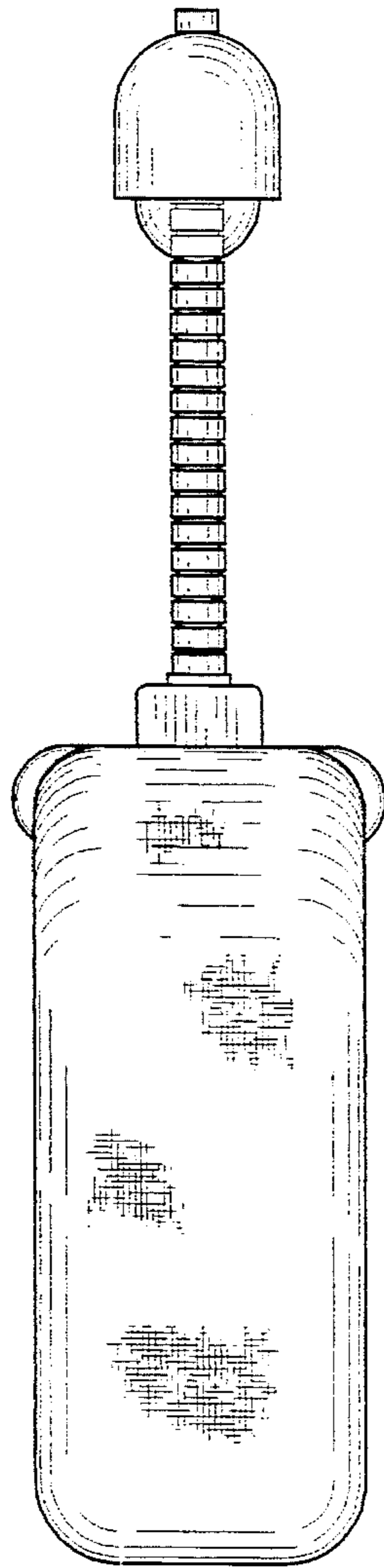

FIG. 4

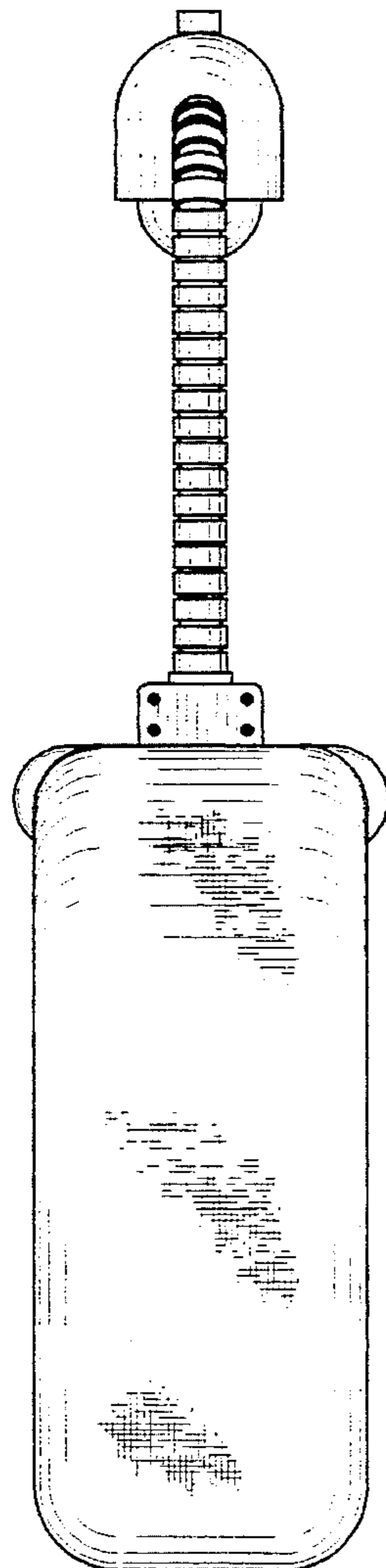

FIG. 5

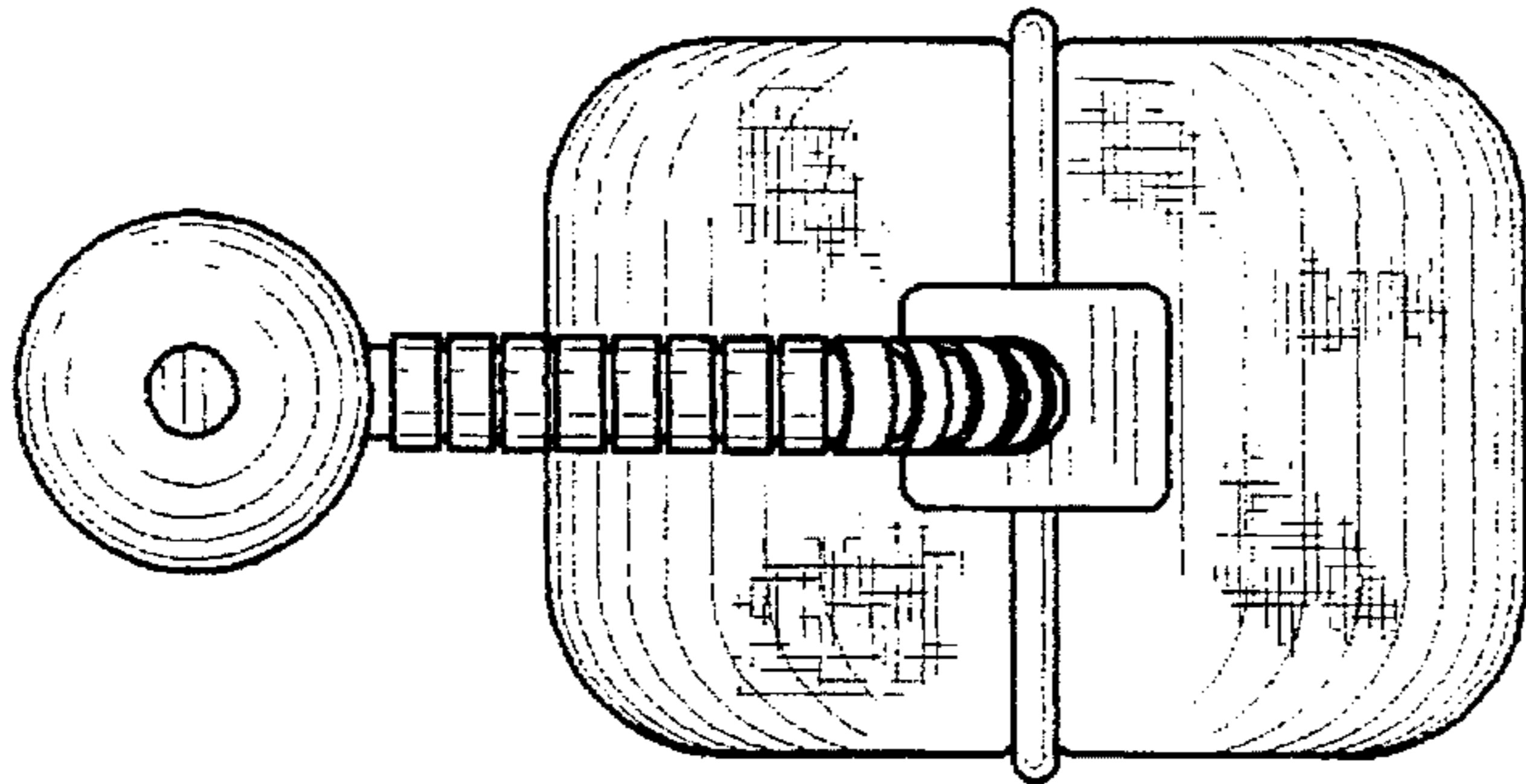

FIG. 6

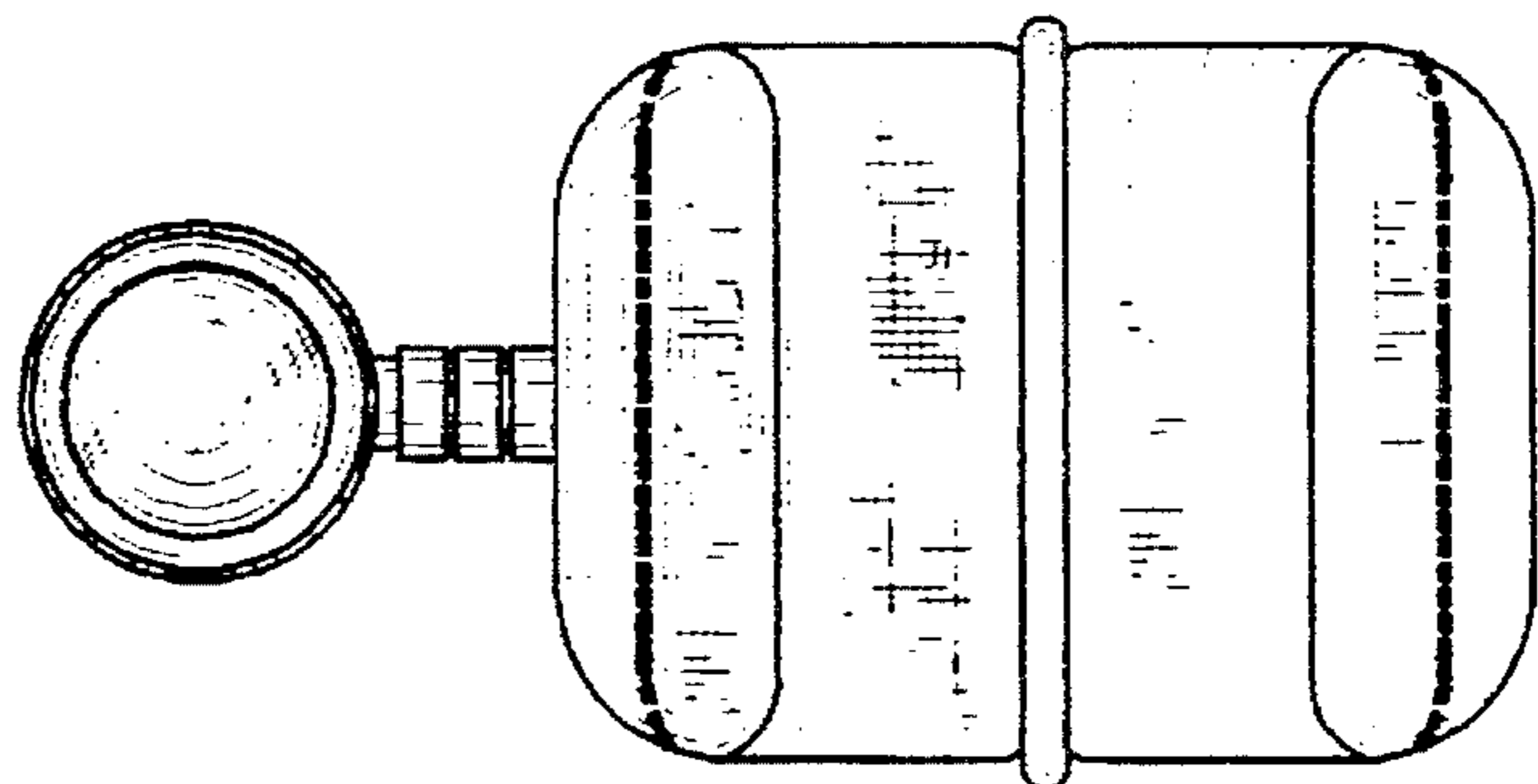

FIG. 7

