



US00D364448S

United States Patent [19]

Wang

[11] Patent Number: **Des. 364,448**

[45] Date of Patent: ****Nov. 21, 1995**

[54] FAUCET

D. 301,162 5/1989 Oberdörfer D23/238

[76] Inventor: **Wen-Mu Wang**, No. 32, Lane 266, Fu Te I Rd., Hsi Tze Chen, Taipei Hsien, Taiwan

Primary Examiner—Stella Reid
Assistant Examiner—Eric Watterson
Attorney, Agent, or Firm—Varndell Legal Group

[**] Term: **14 Years**

[57] **CLAIM**

The ornamental design for a faucet, as shown and described.

[21] Appl. No.: **33,526**

[22] Filed: **Jan. 13, 1995**

[52] U.S. Cl. **D23/238**

[58] Field of Search D23/238-243,
D23/250-258; 4/675-678; 137/801

DESCRIPTION

FIG. 1 is a perspective view of a faucet showing my new design;

FIG. 2 is a front elevational view thereof;

FIG. 3 is a top plan view thereof;

FIG. 4 is a bottom plan view thereof;

FIG. 5 is a left side elevational view thereof;

FIG. 6 is a right side elevational view thereof; and,

FIG. 7 is a rear elevational view thereof.

[56] **References Cited**

U.S. PATENT DOCUMENTS

D. 179,003	10/1956	Herwitz	D23/256
D. 236,895	9/1975	DuBois	D23/255
D. 268,611	4/1983	Klose	D23/222

1 Claim, 7 Drawing Sheets

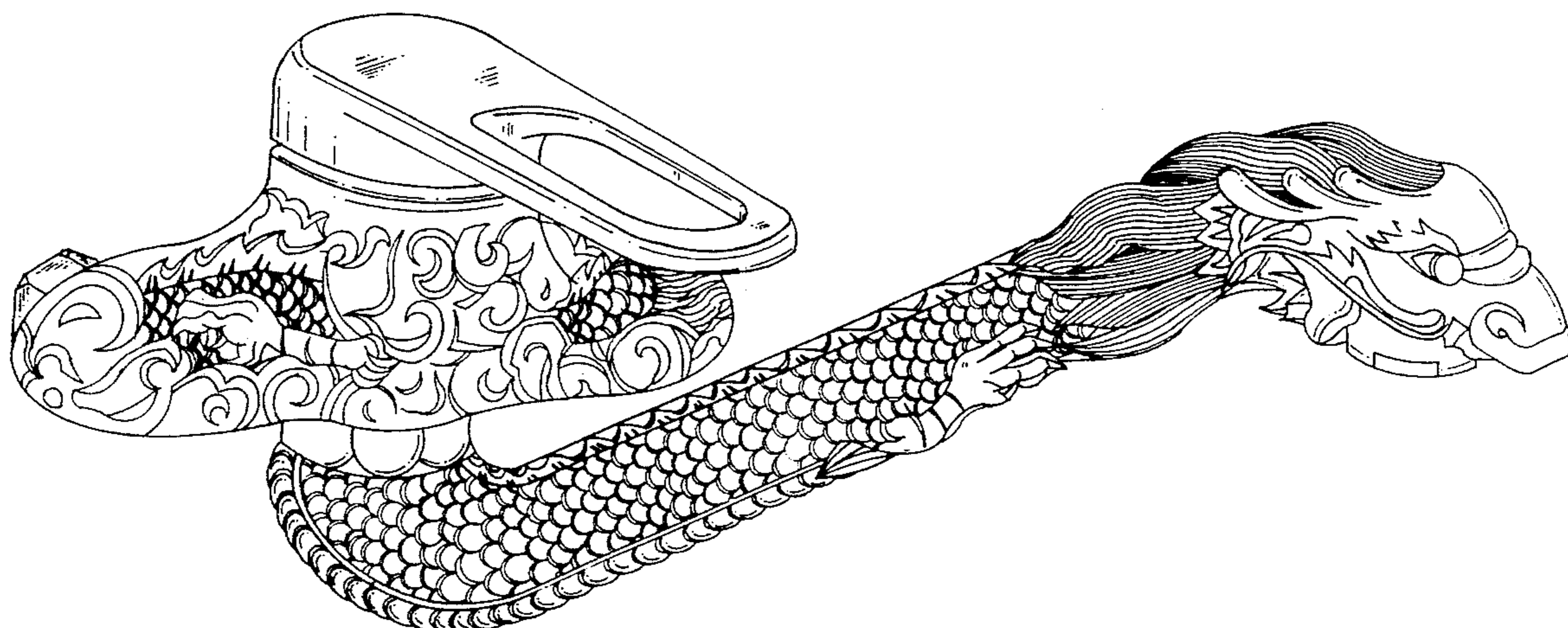

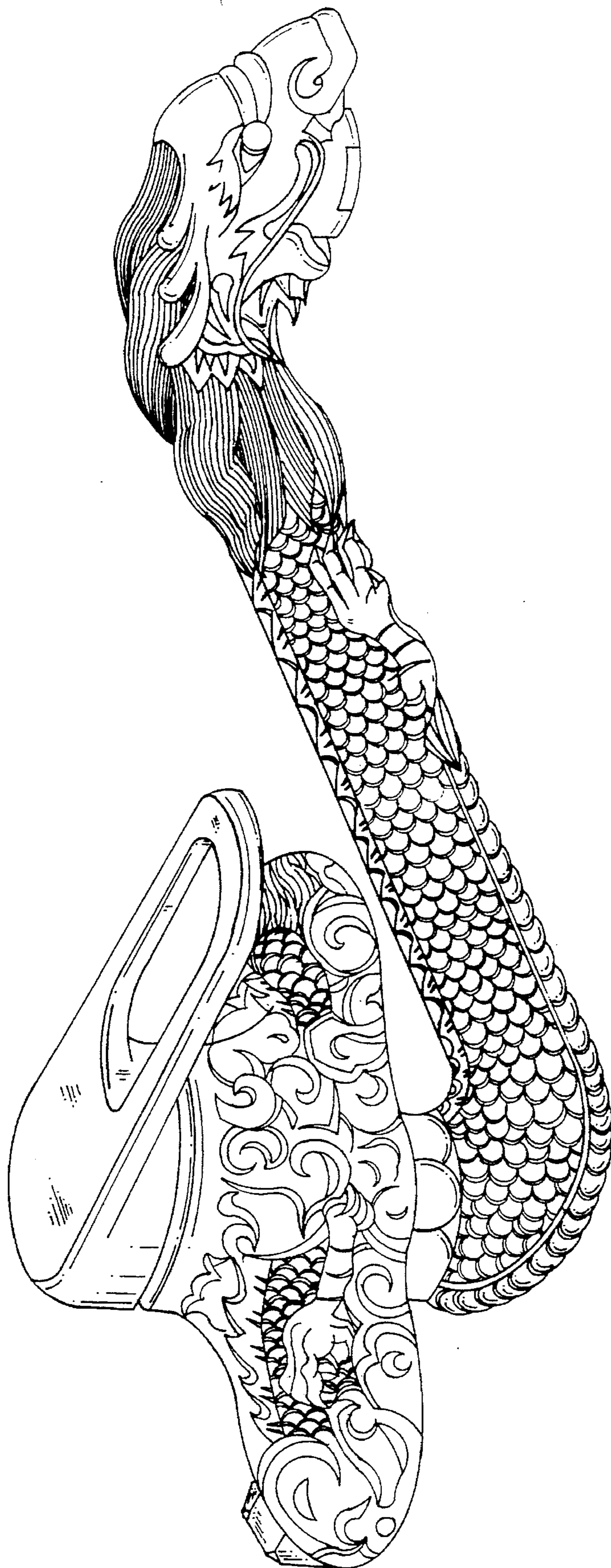

Fig. 1

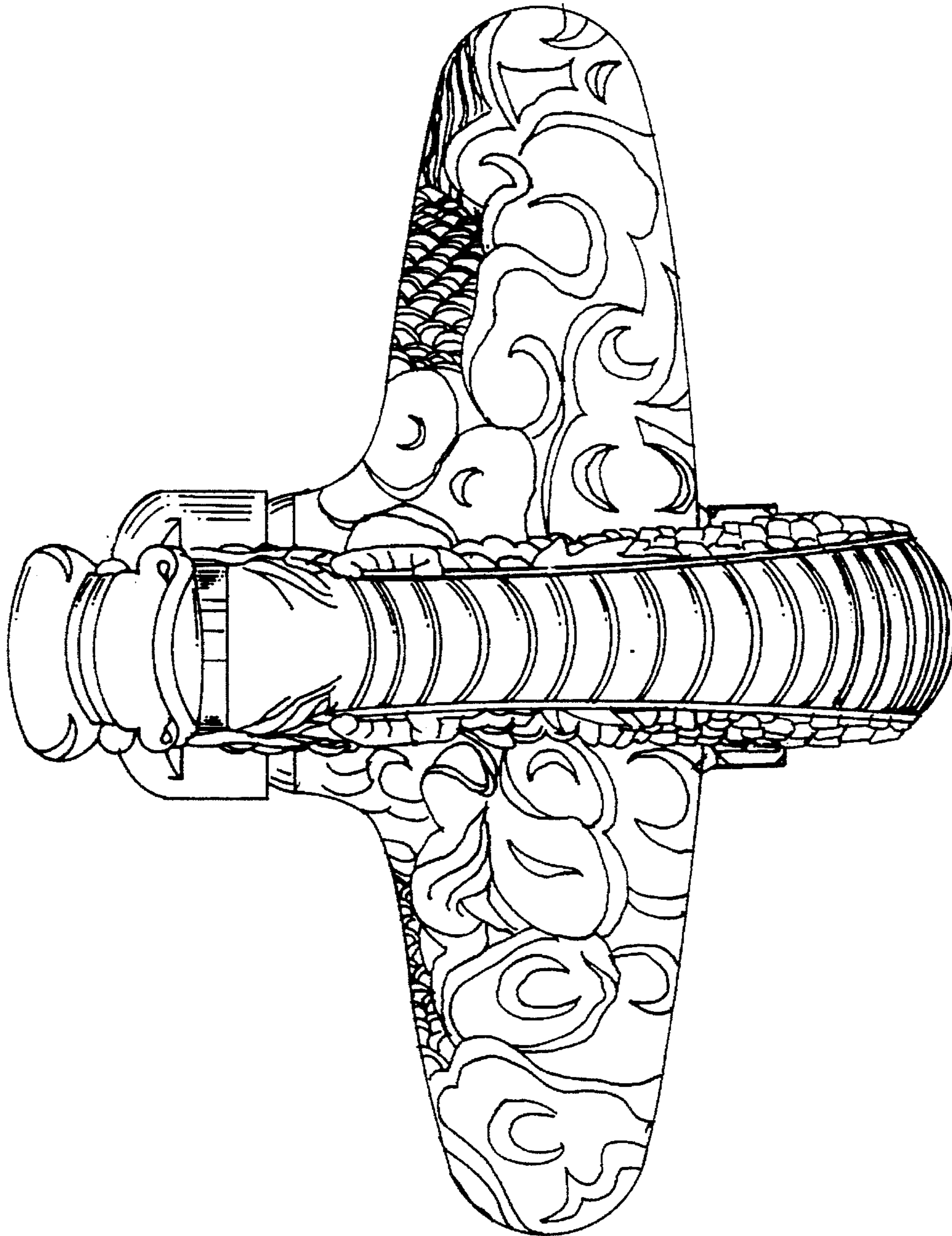

Fig. 2

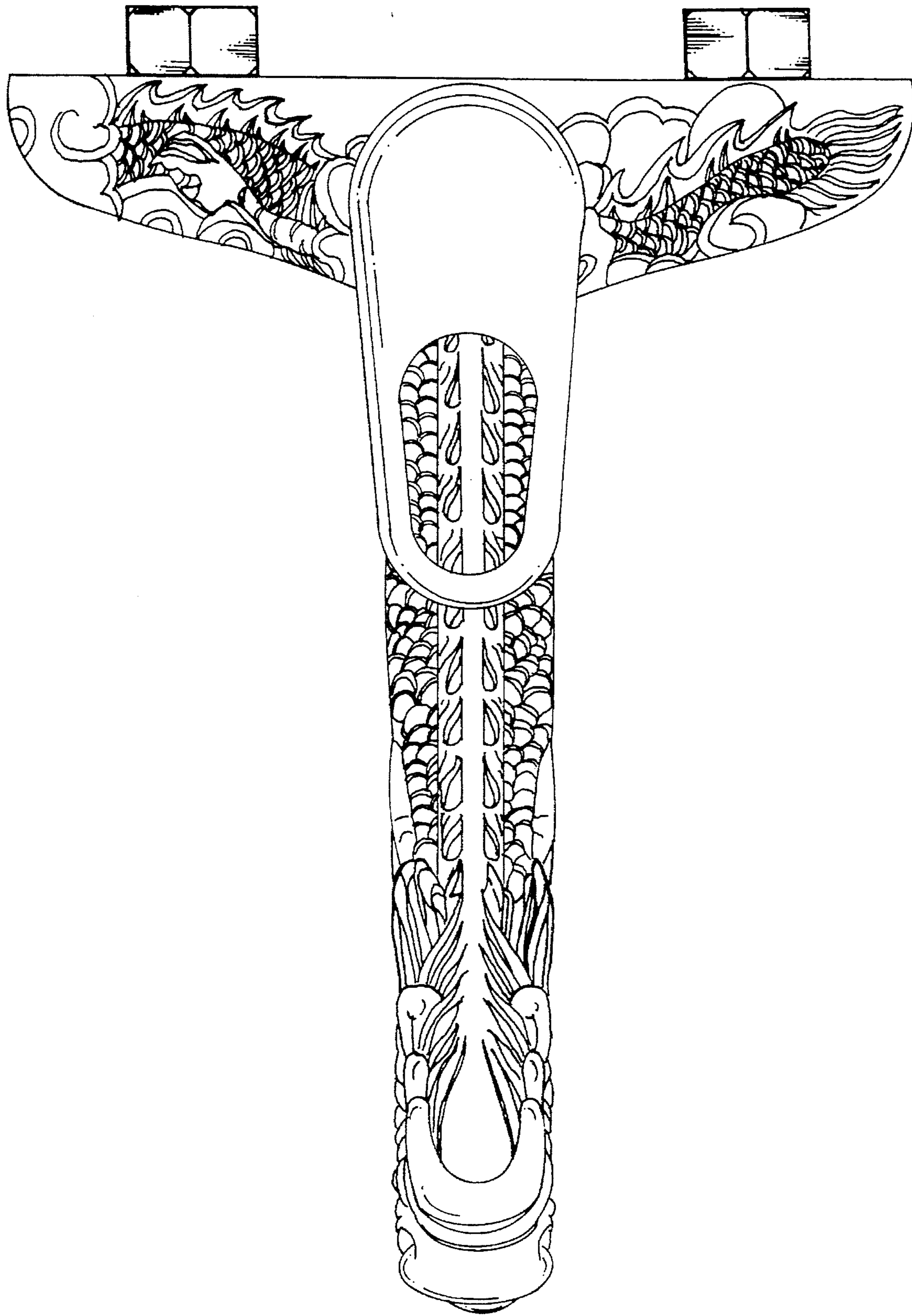

Fig. 3

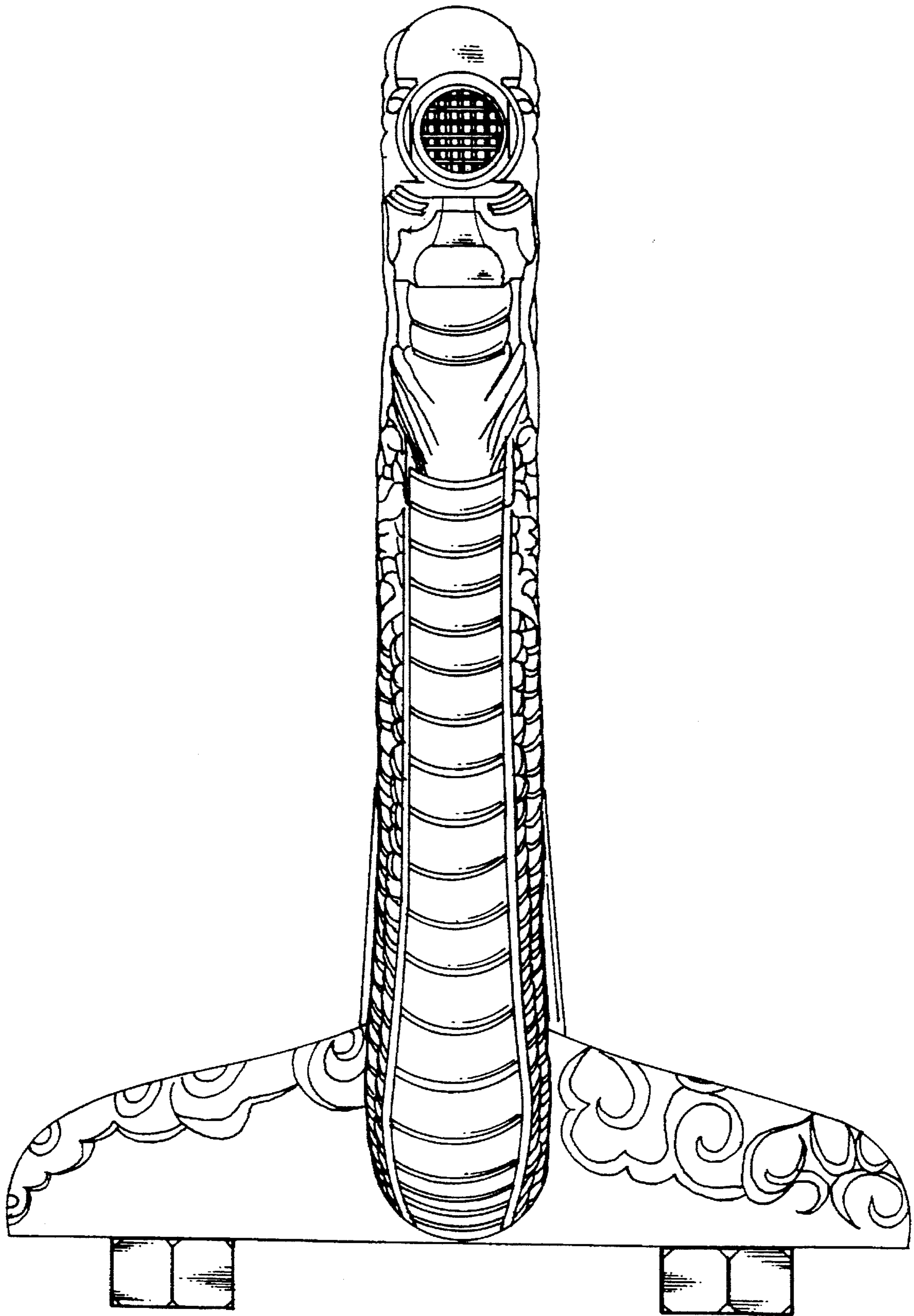

Fig. 4

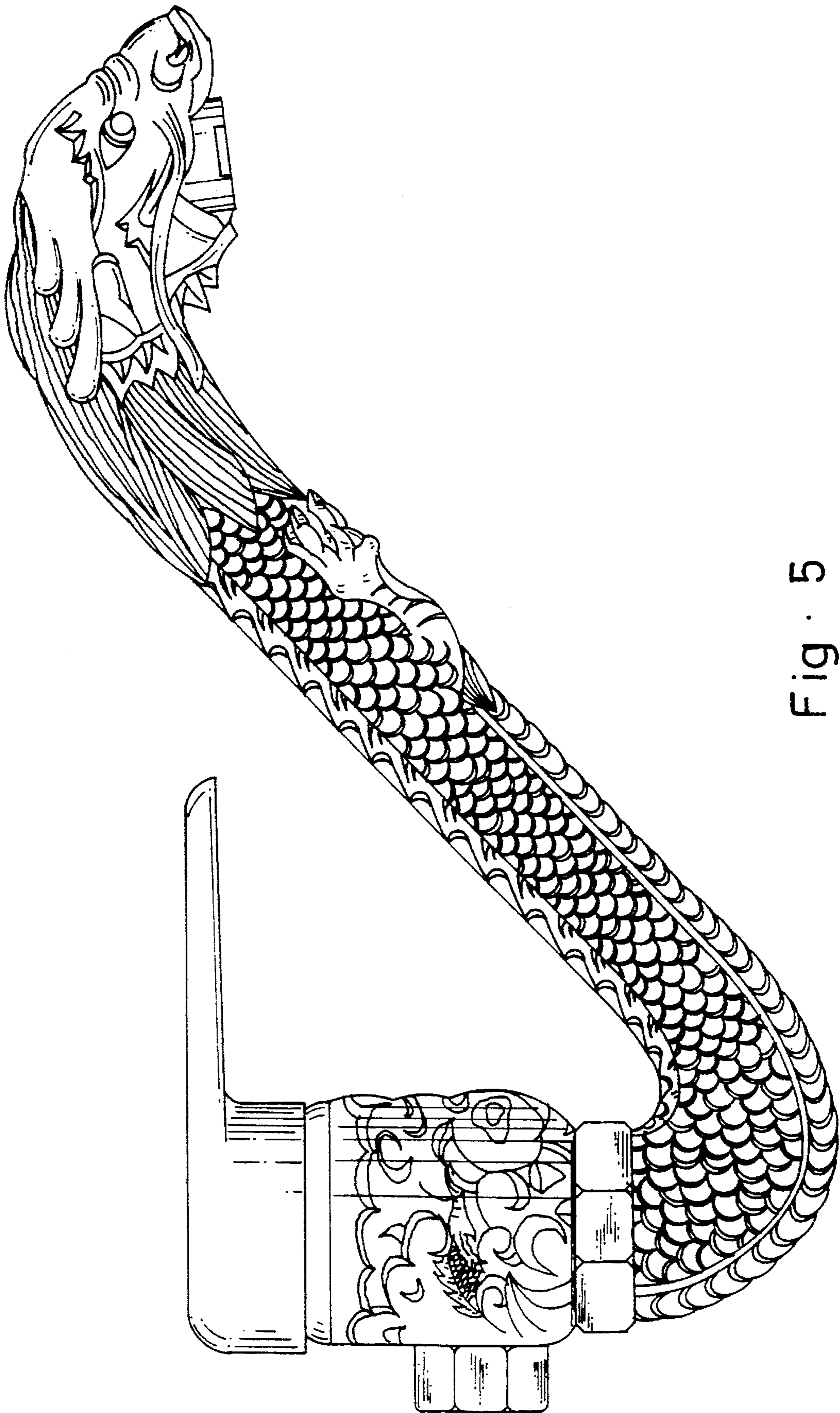

Fig. 5

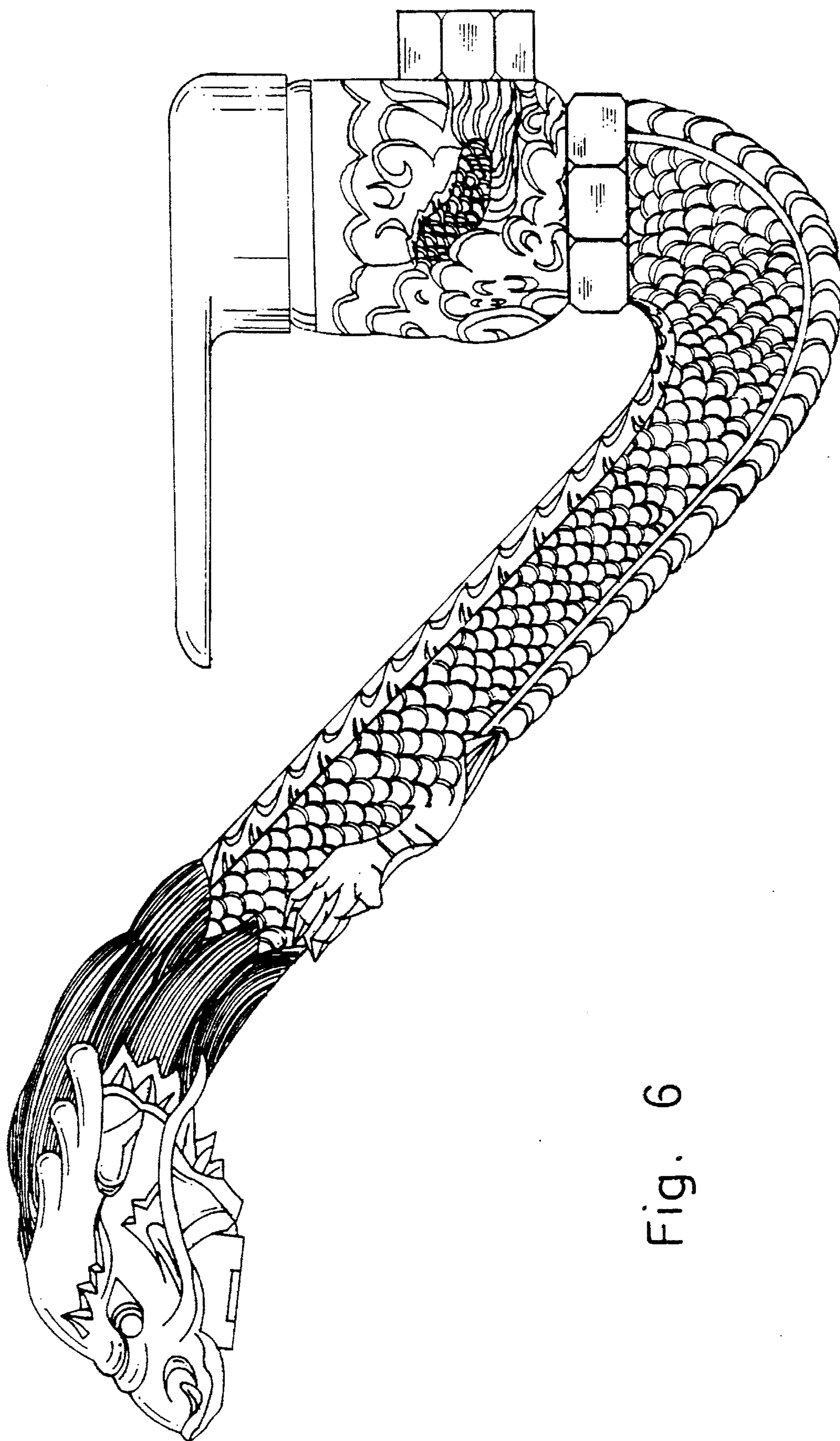

Fig. 6

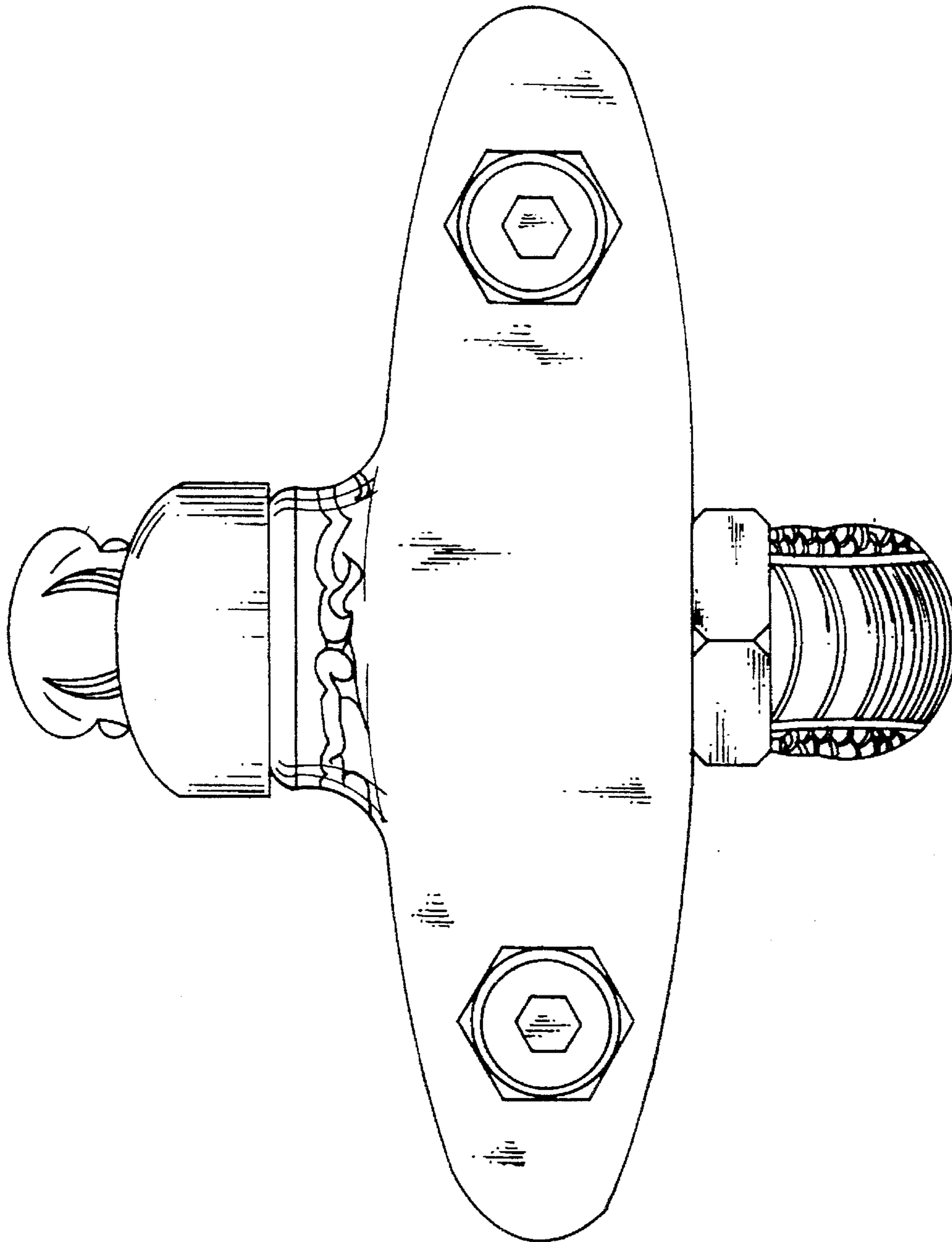

Fig. 7