



US00D364425S

United States Patent [19]
Mage

[11] **Patent Number: Des. 364,425**

[45] **Date of Patent: **Nov. 21, 1995**

[54] **EDUCATIONAL DISPLAY UNIT**

[76] Inventor: **Allen B. Mage**, P.O. Box 42801, Los Angeles, Calif. 90042

[**] Term: **14 Years**

[21] Appl. No.: **701,957**

[22] Filed: **May 15, 1991**

[52] U.S. Cl. **D19/59**

[58] Field of Search D19/59; 434/154,
434/208; 446/128

[56] **References Cited**

U.S. PATENT DOCUMENTS

690,446	1/1902	Levy	446/128
3,616,943	11/1971	Brink	434/208
3,836,217	7/1974	Shüna	446/128
4,883,440	11/1989	Bolli	446/128

FOREIGN PATENT DOCUMENTS

0980235	5/1951	France	446/128
---------	--------	--------------	---------

Primary Examiner—Wallace R. Burke

Assistant Examiner—M. Brown

[57] **CLAIM**

The ornamental design for an educational display unit, as shown and described.

DESCRIPTION

FIG. 1 is a perspective view of an educational display unit

showing my new design;

FIG. 2 is a front elevational view thereof;

FIG. 3 is a rear elevational view thereof;

FIG. 4 is an end elevational view thereof, the opposite end being a mirror image of that shown;

FIG. 5 is a top plan view thereof;

FIG. 6 is a bottom plan view thereof;

FIG. 7 is a side elevational view of one of the beveled plates forming part of the display unit;

FIG. 8 is a top plan view of the beveled plate in FIG. 7;

FIG. 9 is a bottom plan view of the beveled plate in FIG. 7;

FIG. 10 is an end elevational view of the beveled plate in FIG. 7, the opposite end being a mirror image of that end shown in FIG. 7;

FIG. 11 is a top plan view of one of the flat plates forming part of the display unit;

FIG. 12 is a bottom plan view of the flat plate in FIG. 11;

FIG. 13 is a side elevational view of the flat plate in FIG. 11, the opposite side being a mirror image of that side shown in FIG. 11;

FIG. 14 is an end elevational view of the plate in FIG. 11, the opposite end being a mirror image of that end shown in FIG. 11; and,

FIG. 15 is an exploded perspective view thereof showing the assembly of all the plates forming the display unit.

The broken lines shown in FIGS. 11 and 12 are for illustrative purposes only and form no part of the claimed design.

1 Claim, 5 Drawing Sheets

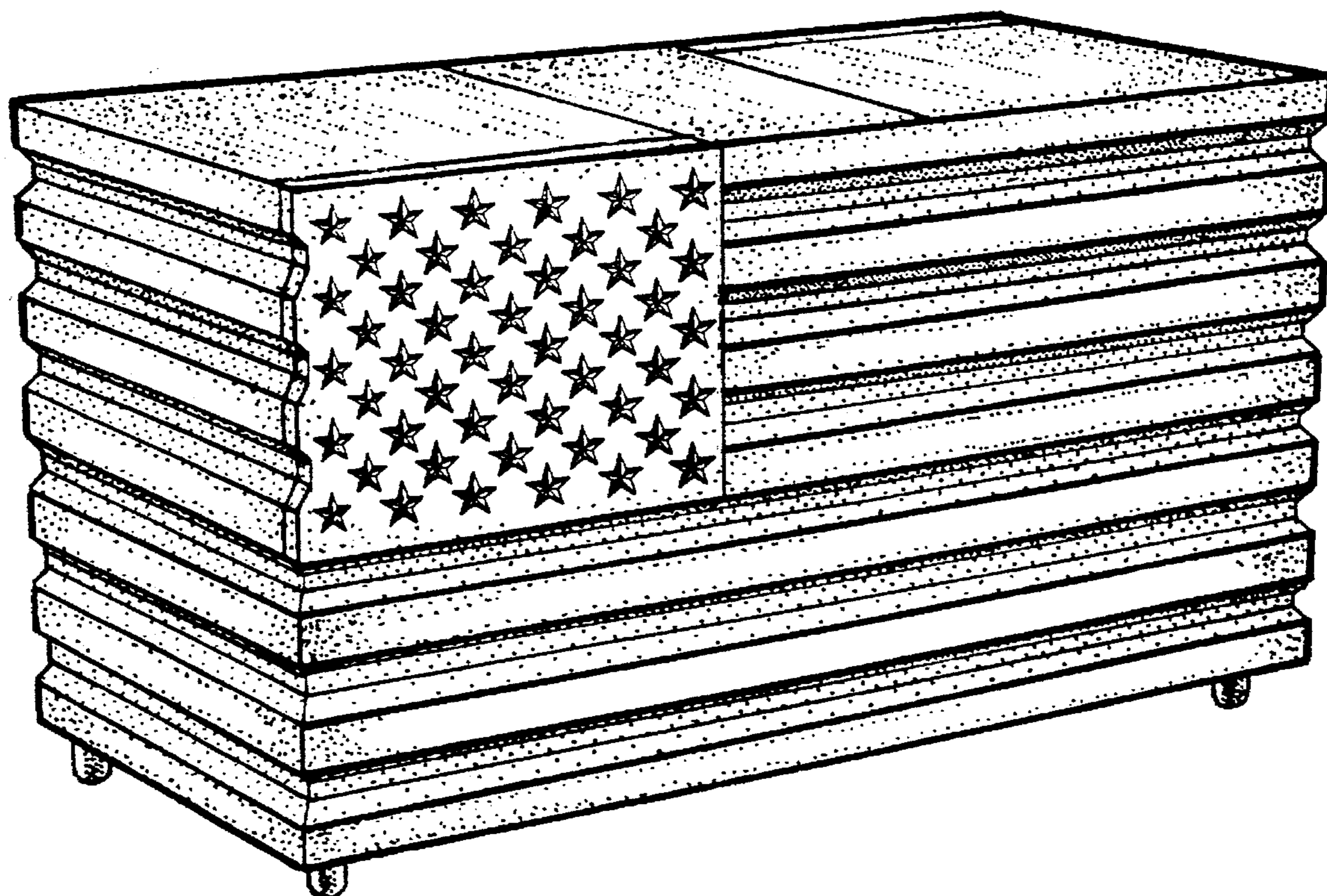

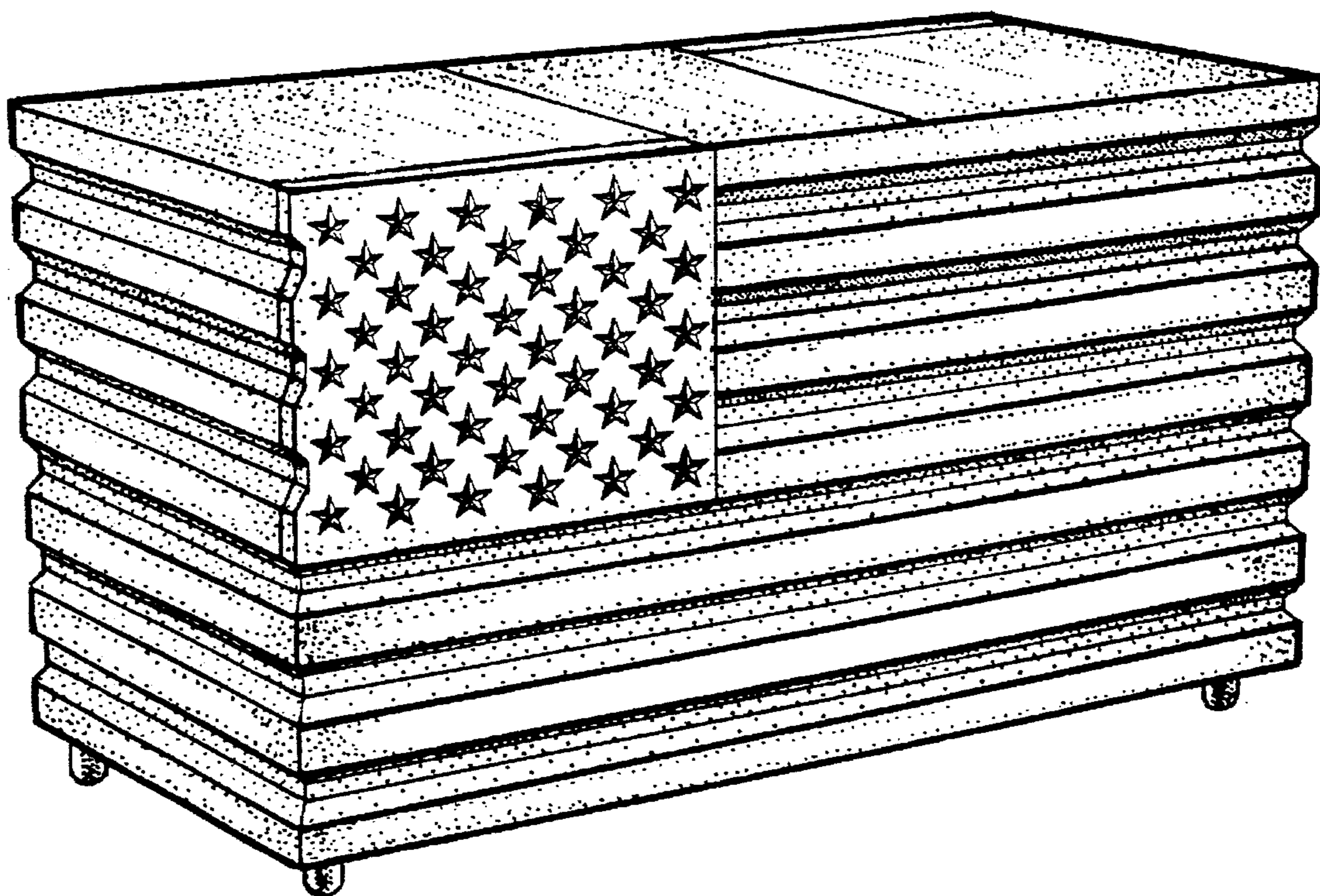

FIG. 1

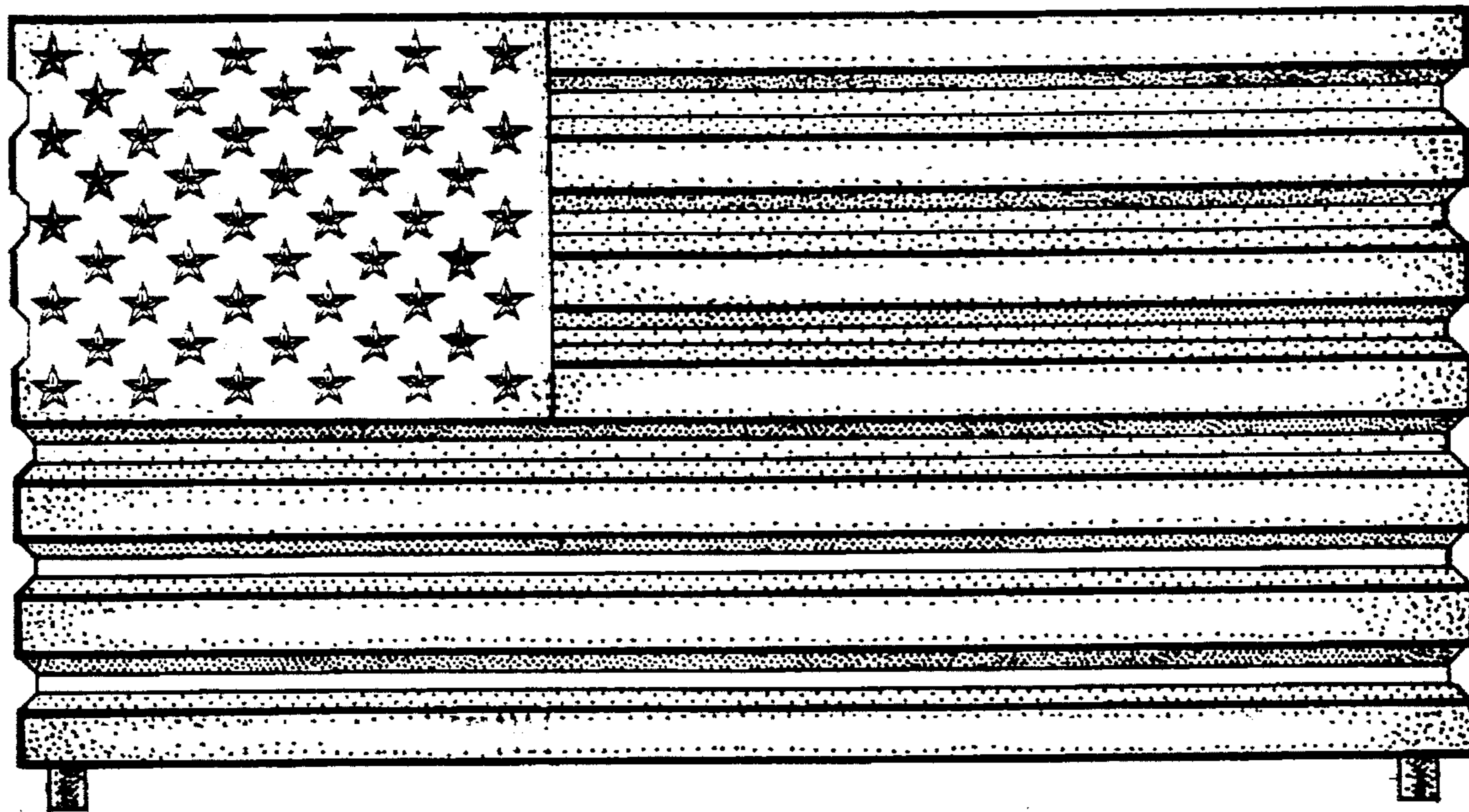

FIG. 2

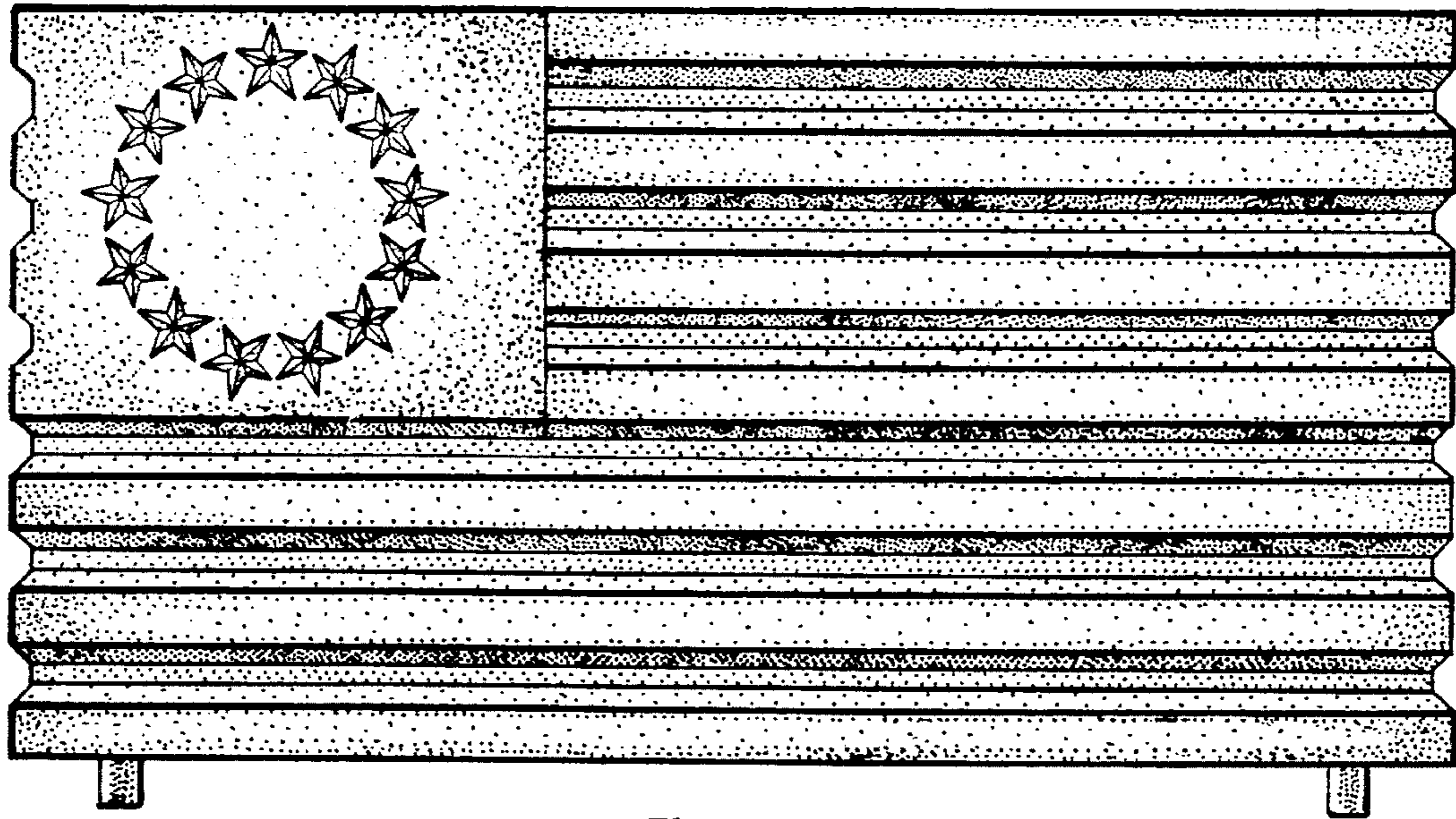

FIG. 3

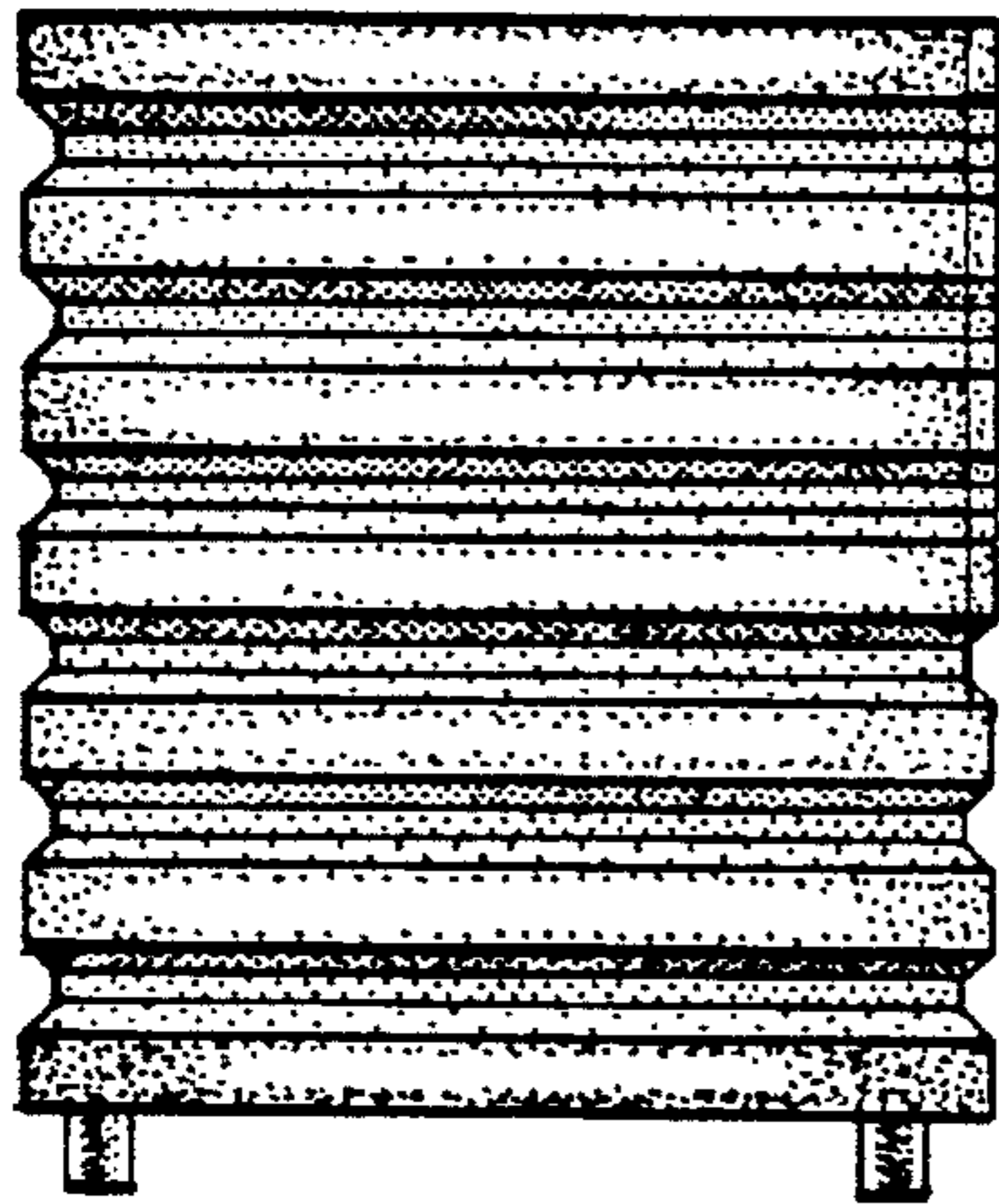

FIG. 4

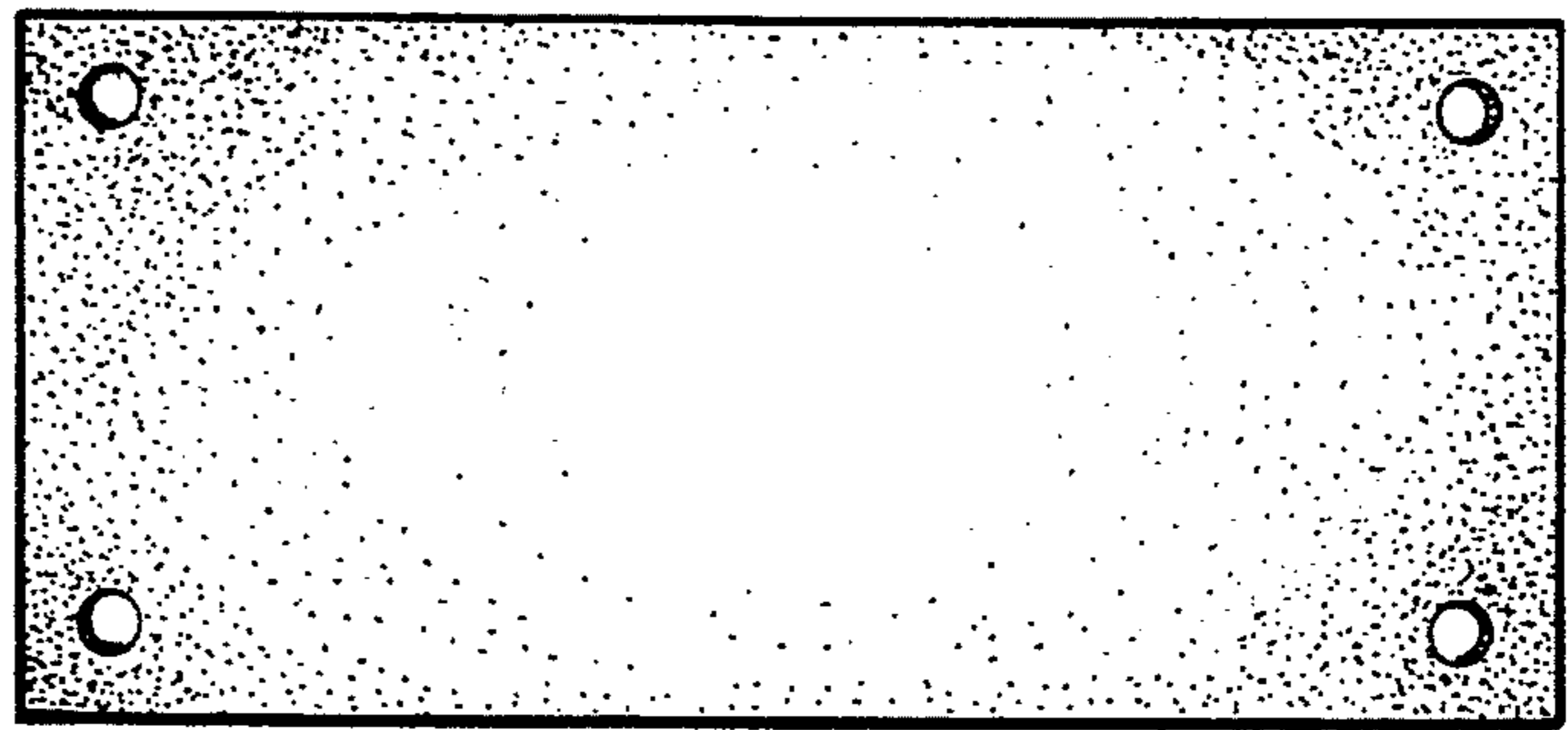

FIG 6

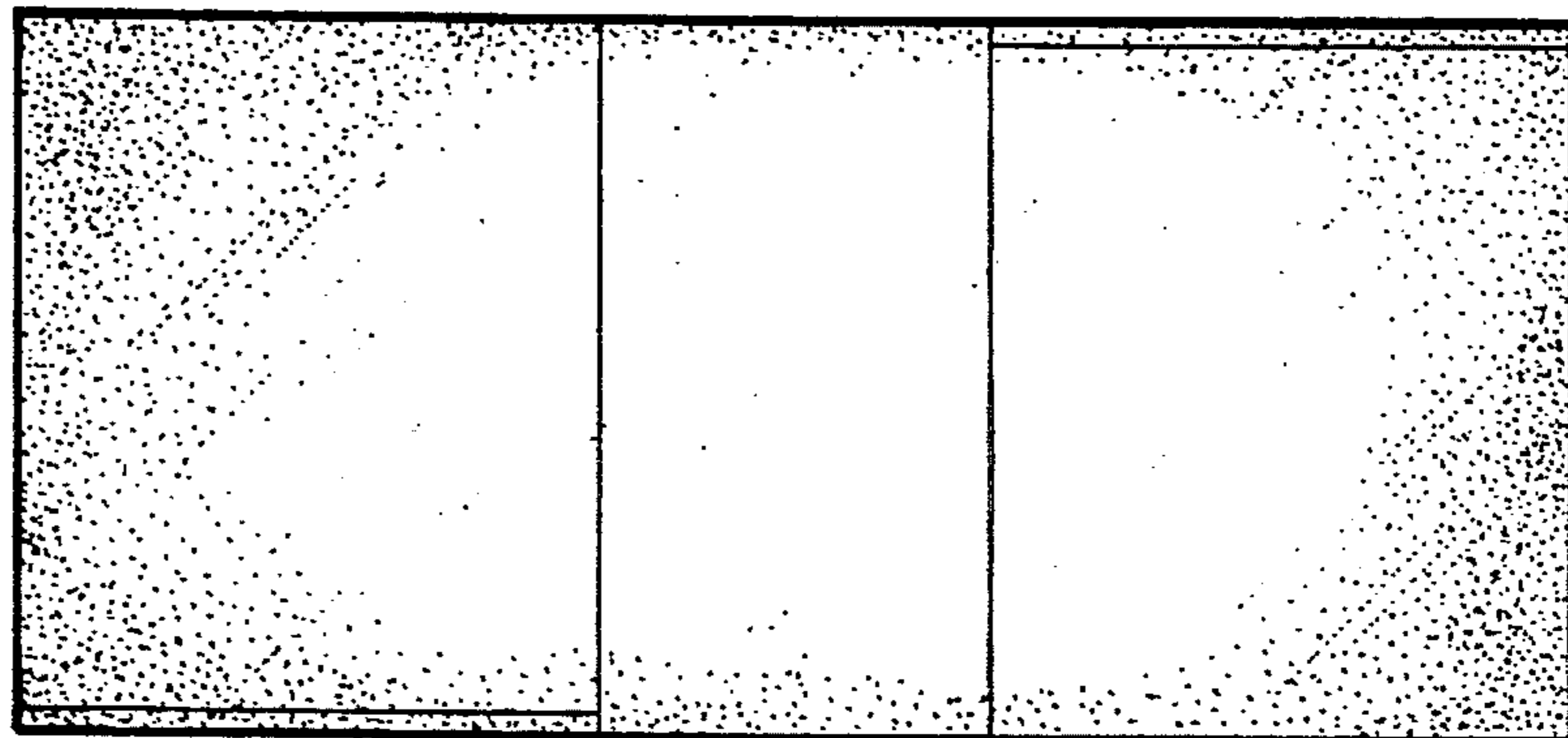

FIG. 5

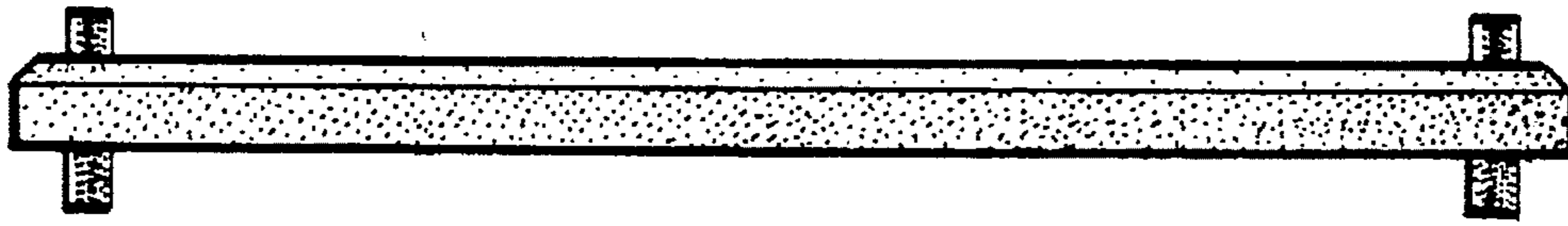

FIG. 7

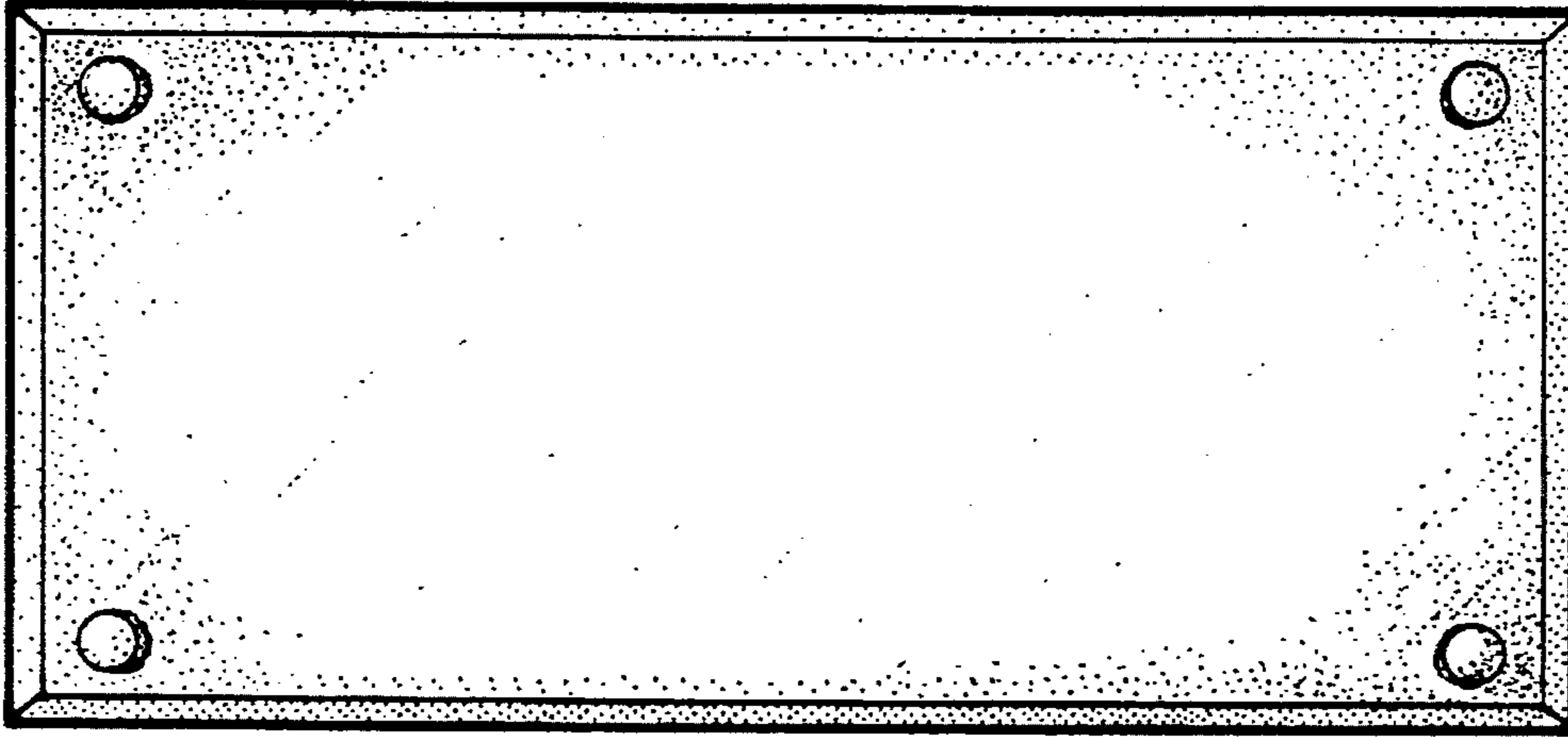

FIG. 8

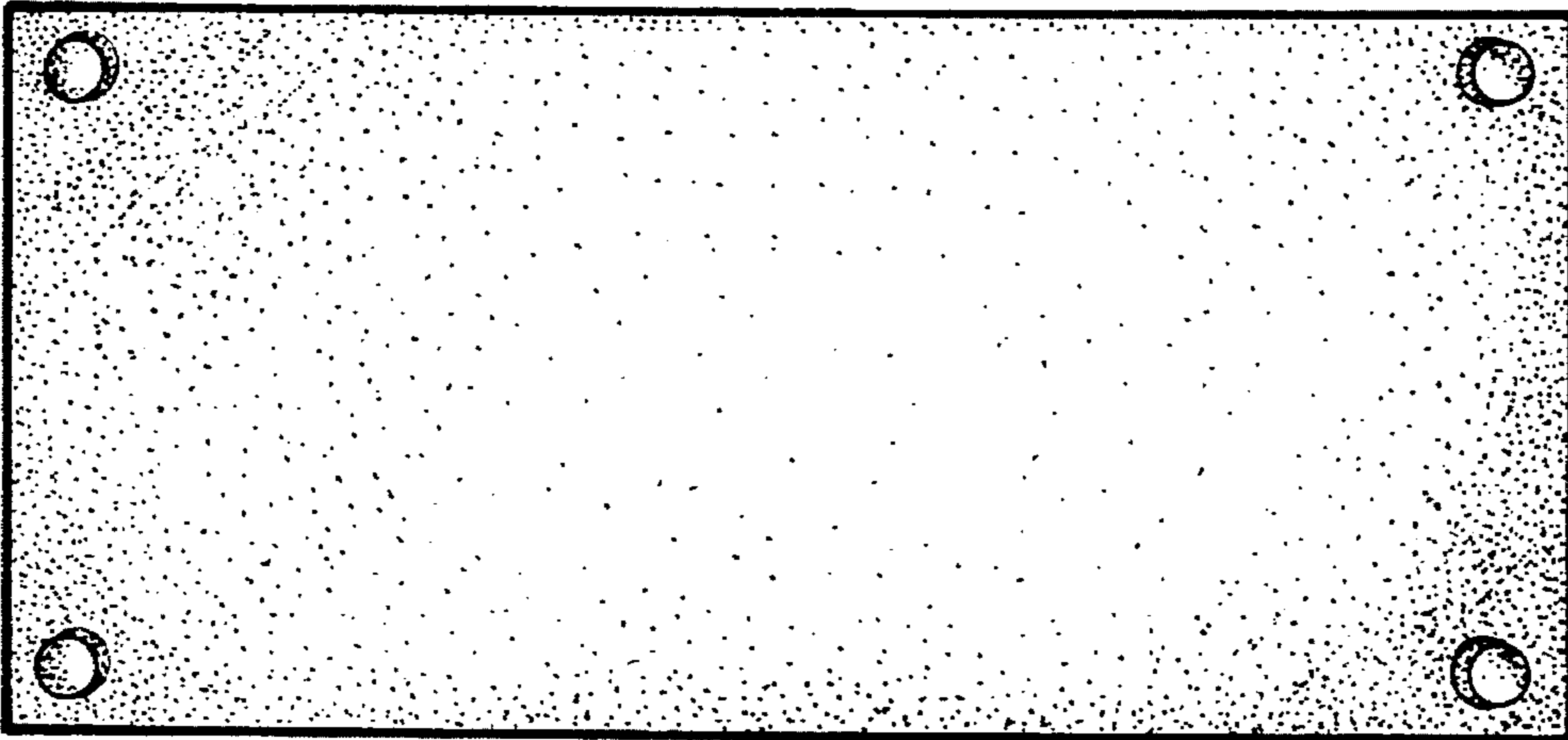

FIG. 9

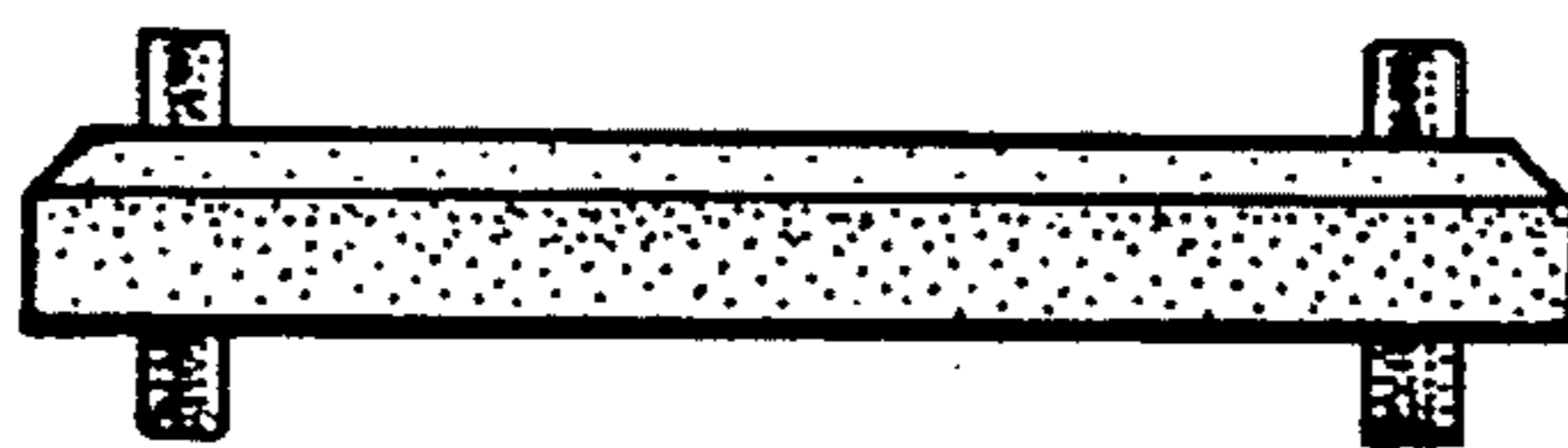

FIG. 10

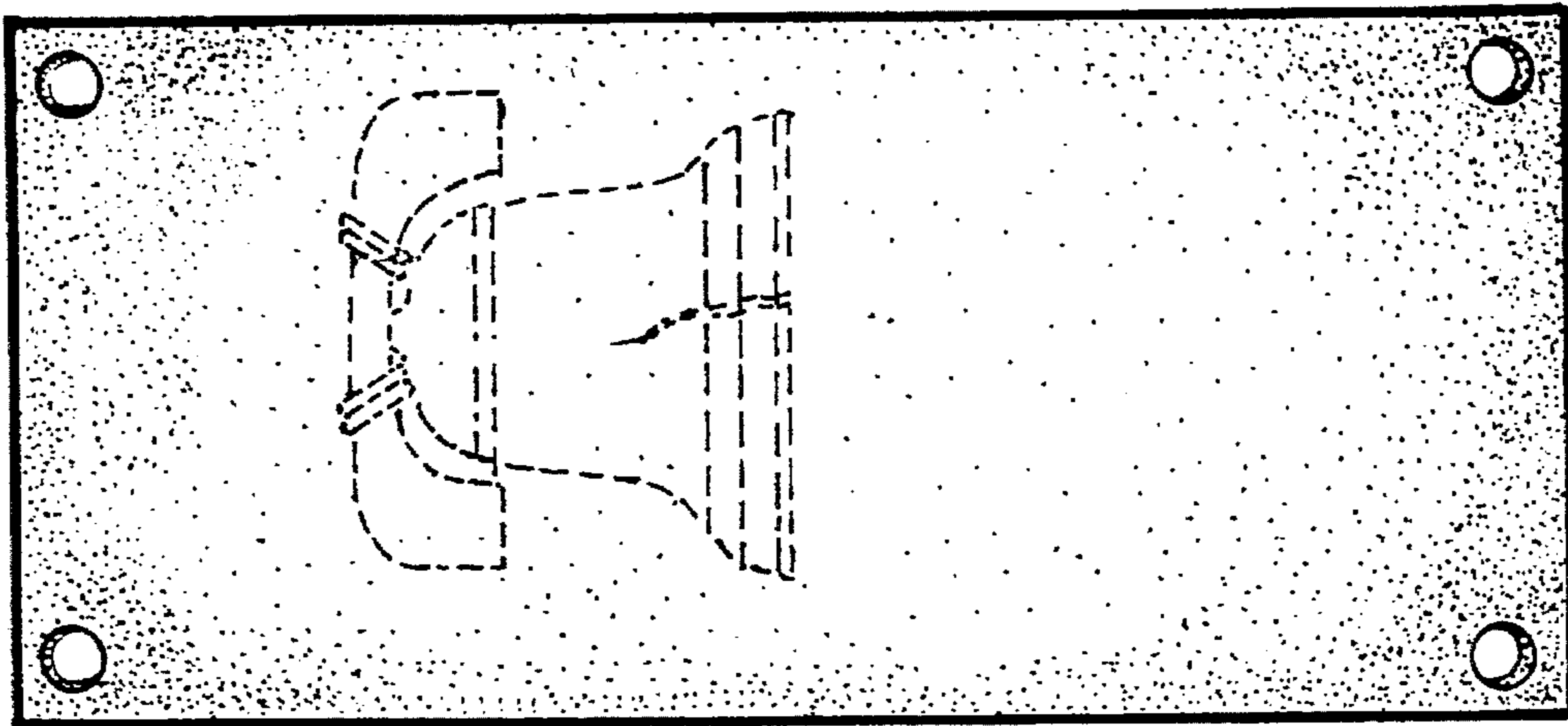

FIG. 11

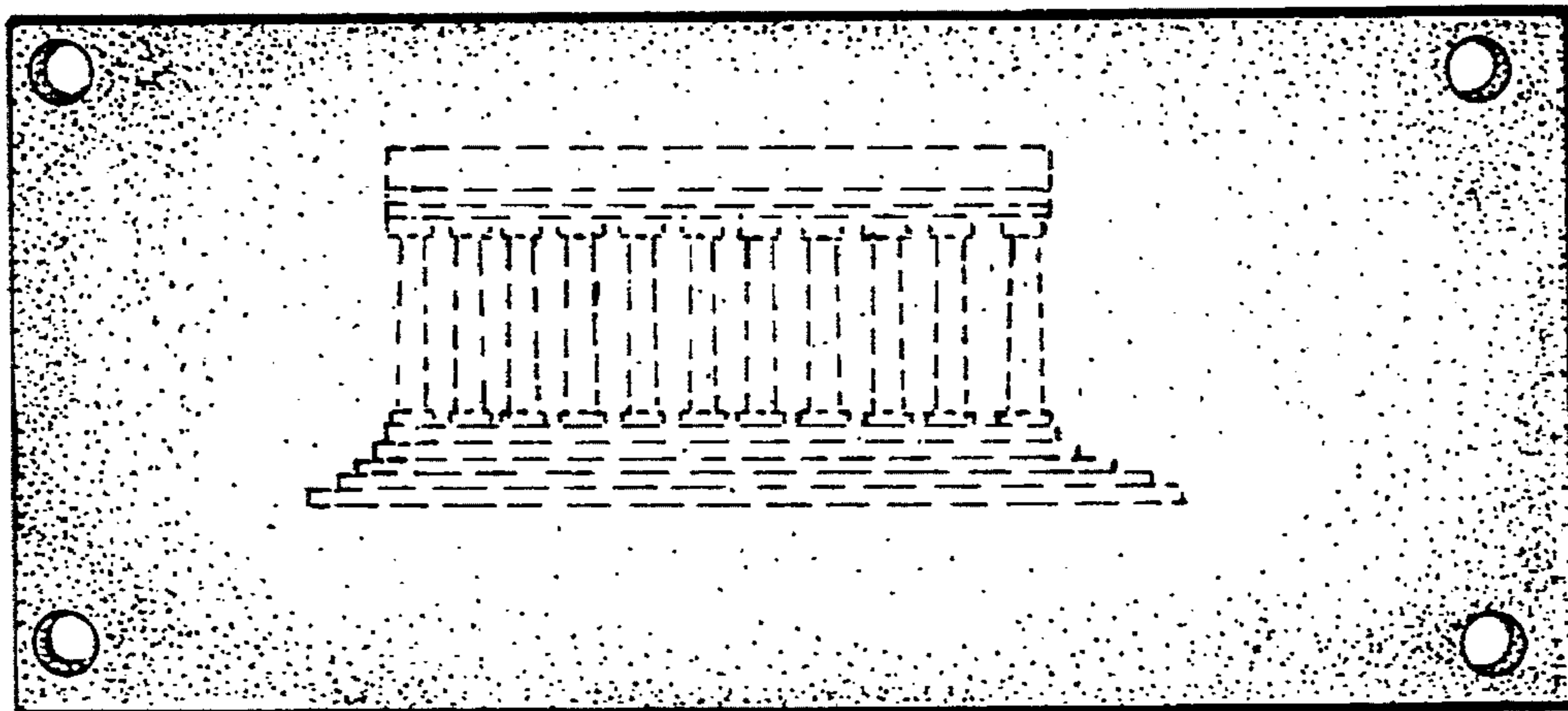

FIG. 12



FIG. 13



FIG. 14

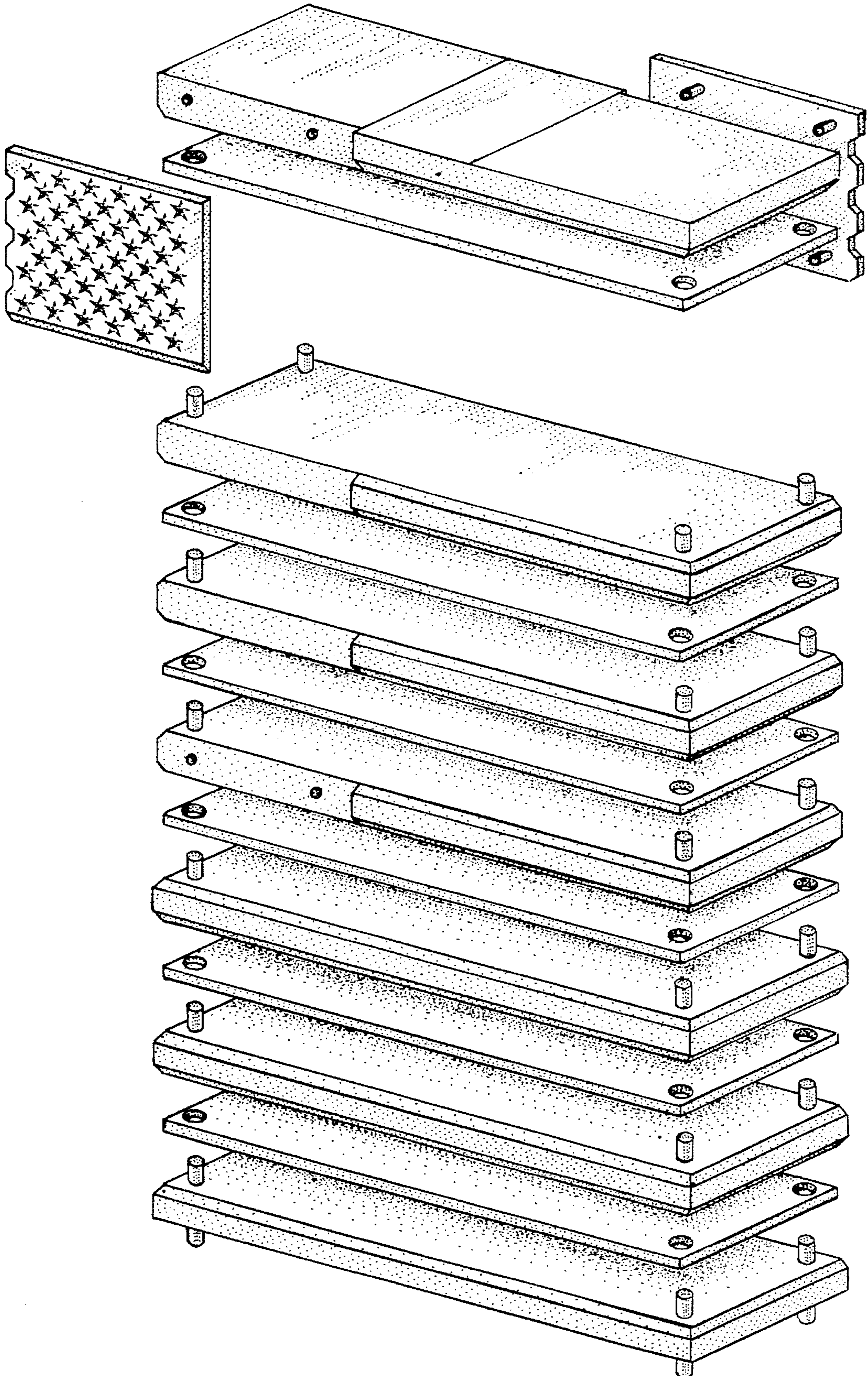

FIG. 15