



US00D364288S

United States Patent [19]

[11] Patent Number: **Des. 364,288**

Kramer et al.

[45] Date of Patent: ****Nov. 21, 1995**

[54] **COMBINED BAKERS RACK AND ORGANIZER**

3,998,170 12/1976 Gordon 108/91
4,191,160 3/1980 Elliot 211/181 X

[75] Inventors: **Louise P. Kramer; Elizabeth A. Denis**, both of St. Paul; **Brian H. Ye**, Brooklyn Center, all of Minn.

Primary Examiner—Jeffrey Asch
Attorney, Agent, or Firm—Kinney & Lange

[73] Assignee: **L & L Products, Inc.**, St. Paul, Minn.

[57] **CLAIM**

[**] Term: **14 Years**

The ornamental design for a combined baker's rack and organizer, as shown and described.

[21] Appl. No.: **26,905**

DESCRIPTION

[22] Filed: **Aug. 9, 1994**

Related U.S. Application Data

[63] Continuation-in-part of Ser. No. 10,115, Jun. 28, 1993, abandoned.

[52] **U.S. Cl.** **D6/465; D7/388; D7/409**

[58] **Field of Search** **D6/449, 411, 462-465, D6/477-479; 211/181, 13, 126; 108/59.91; D7/409, 388, 704, 708**

FIG. 1 is a perspective view of a combined baker's rack and organizer showing a first embodiment of our new design; FIG. 2 is a front elevational view thereof; FIG. 3 is a right side view thereof; FIG. 4 is a top plan view thereof; FIG. 5 is a bottom view thereof; FIG. 6 is a perspective view of a combined baker's rack and organizer showing a second embodiment of our new design; FIG. 7 is a front elevational view thereof; FIG. 8 is a right side view thereof; FIG. 9 is a top plan view thereof; FIG. 10 is a bottom view thereof; FIG. 11 is a perspective view of a combined baker's rack and organizer showing a third embodiment of our new design; FIG. 12 is a front elevational view thereof; FIG. 13 is a right side view thereof; FIG. 14 is a top plan view thereof; and, FIG. 15 is a bottom view thereof.

[56] References Cited

U.S. PATENT DOCUMENTS

D. 206,549	12/1966	Callender	D7/409
D. 232,340	8/1974	Lax	D7/708
D. 278,196	4/1985	Koves	D6/465
D. 290,970	7/1987	Rich	D6/462 X
D. 319,356	8/1991	Vukelich, Sr.	D6/464 X
D. 329,954	10/1992	Sharon et al.	D6/462
D. 334,307	3/1993	Lee	D6/462
D. 334,854	4/1993	Pestone	D6/462 X

The rear elevational and left side views of each embodiment are the same as the front elevational and right side views, respectively.

1 Claim, 13 Drawing Sheets

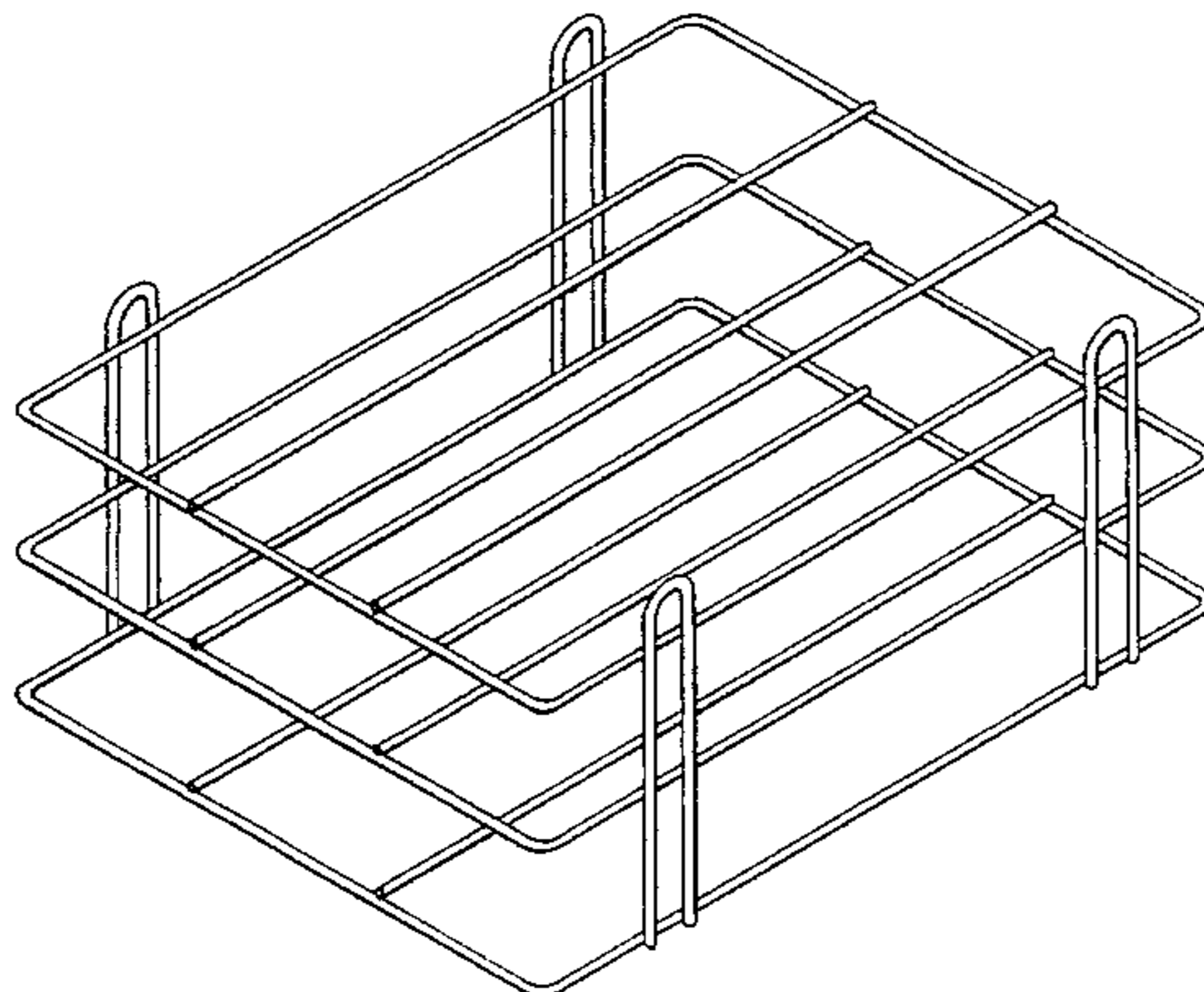
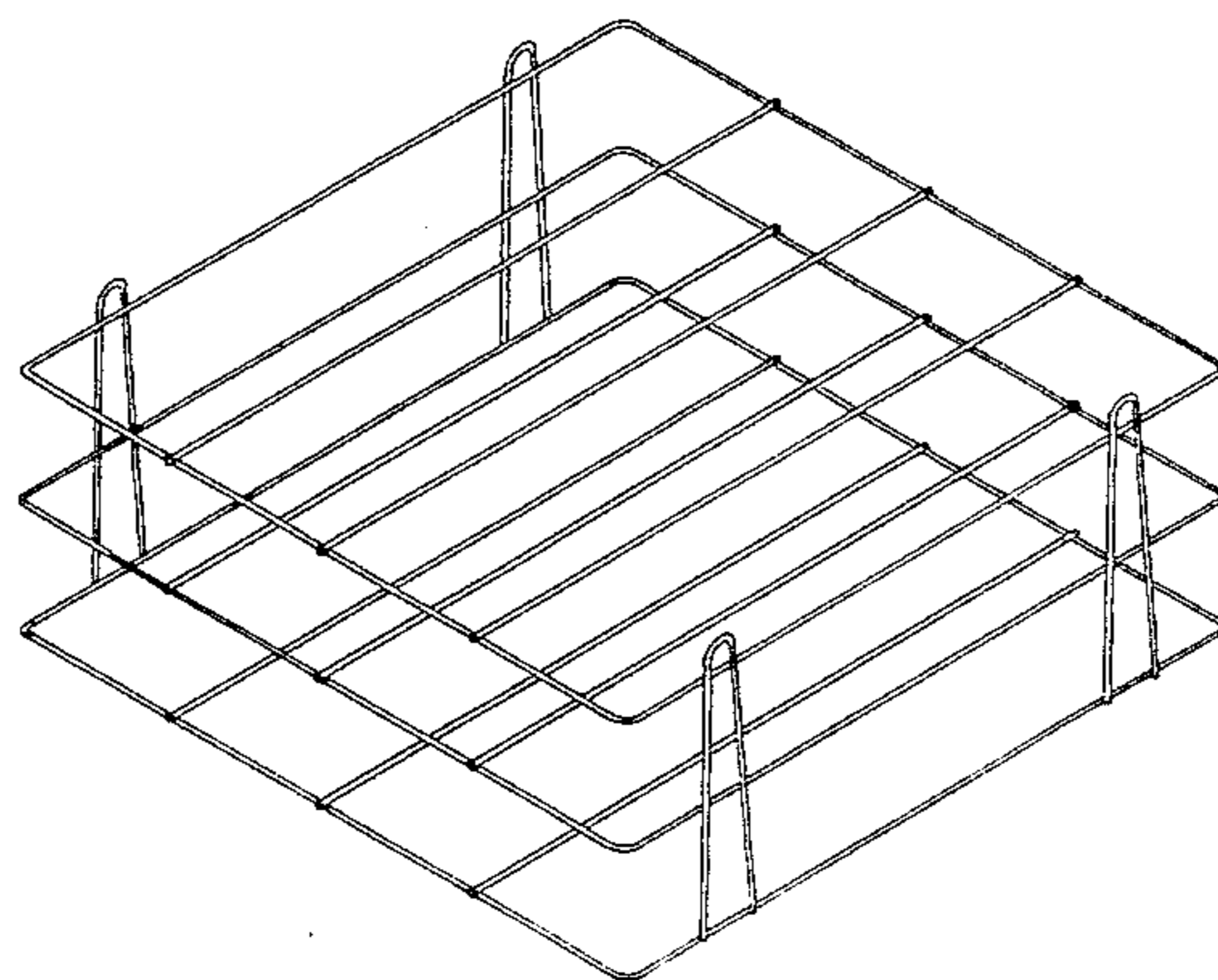

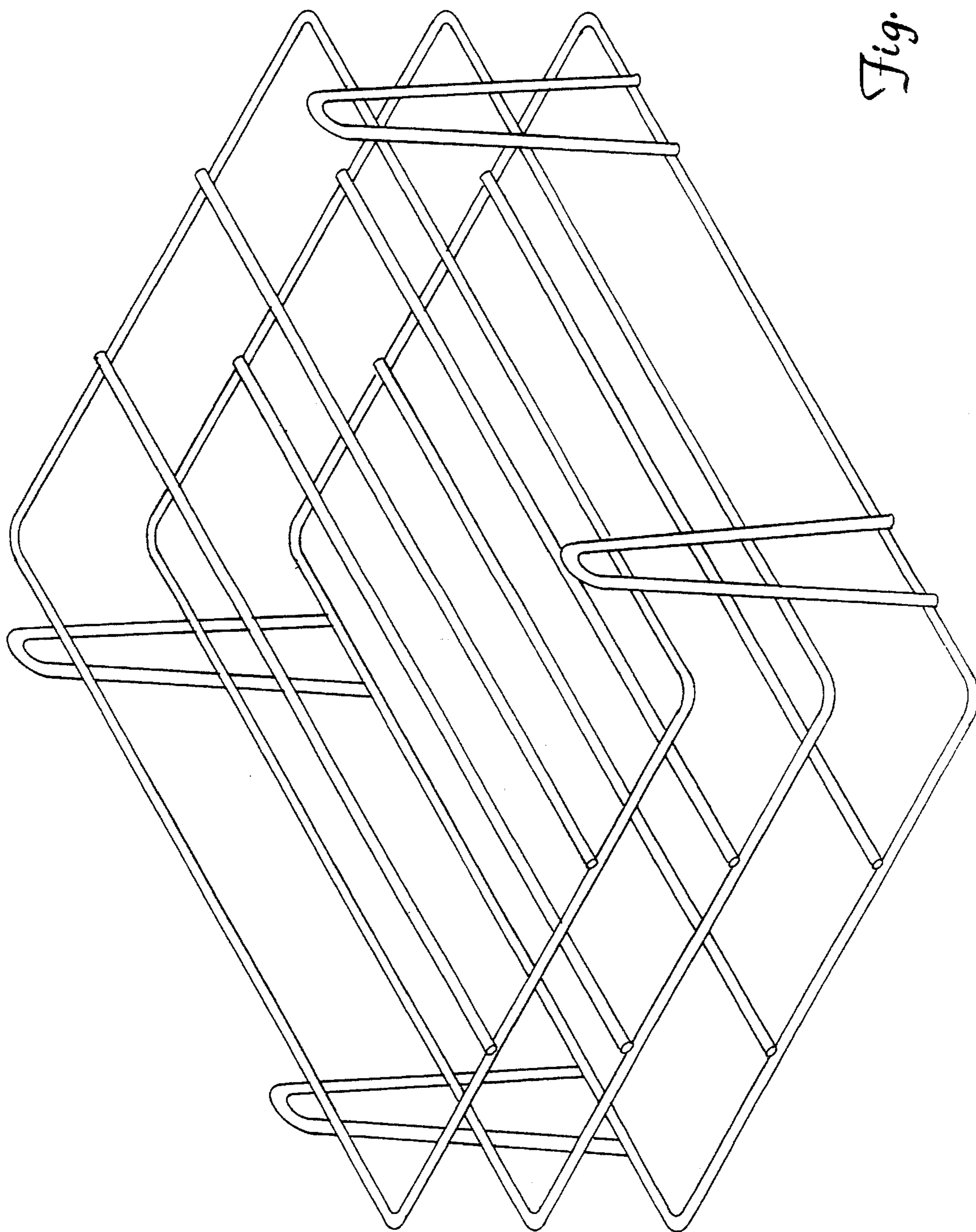

Fig. 1

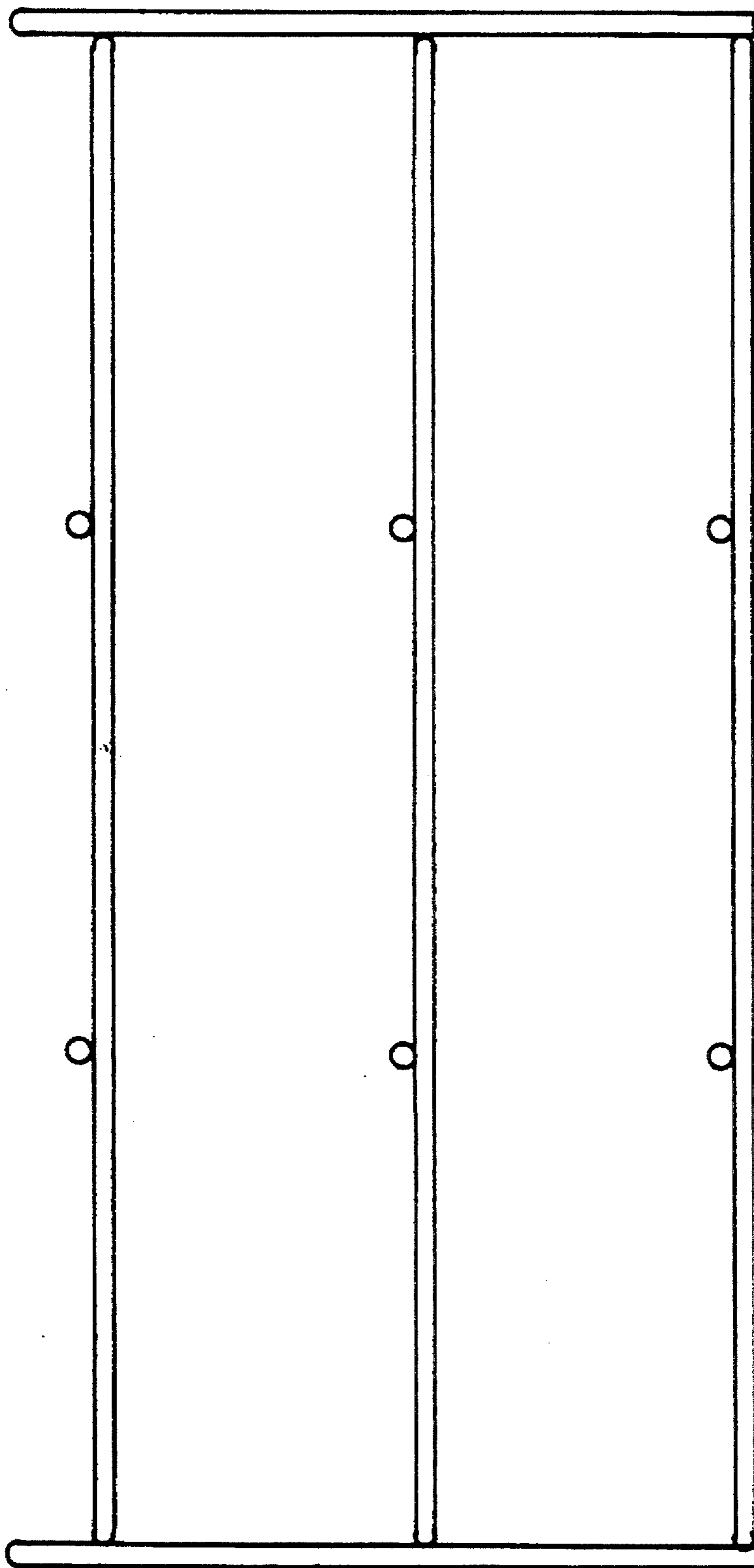

Fig. 2

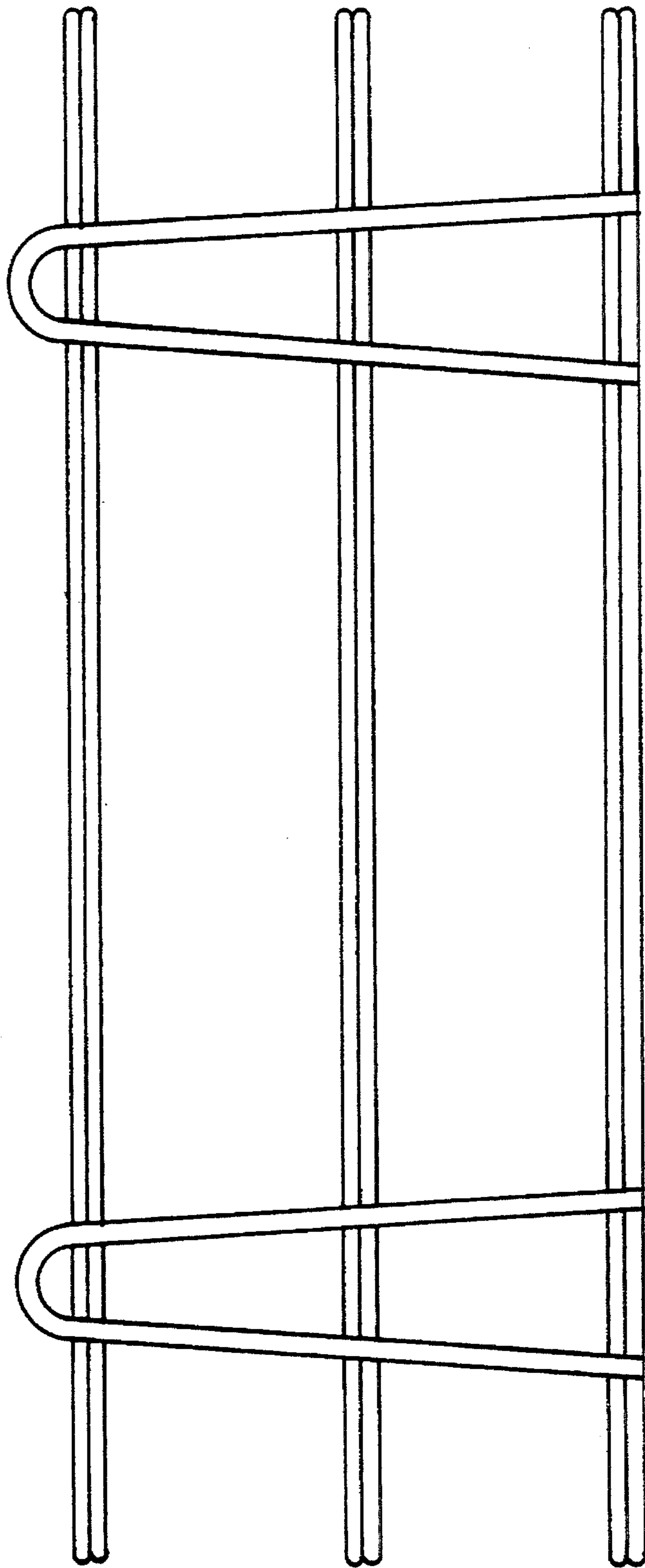

Fig. 3

Fig. 4

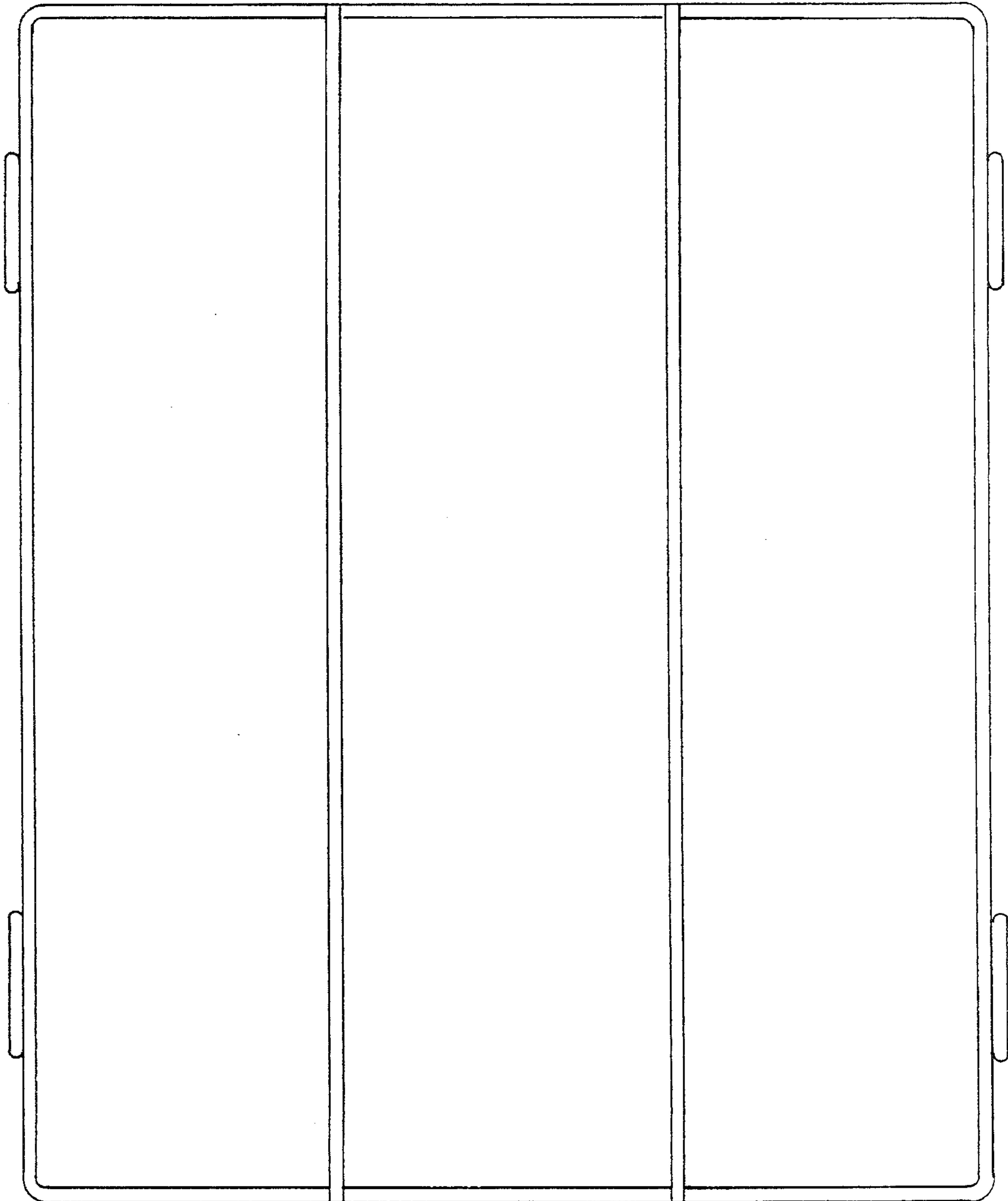
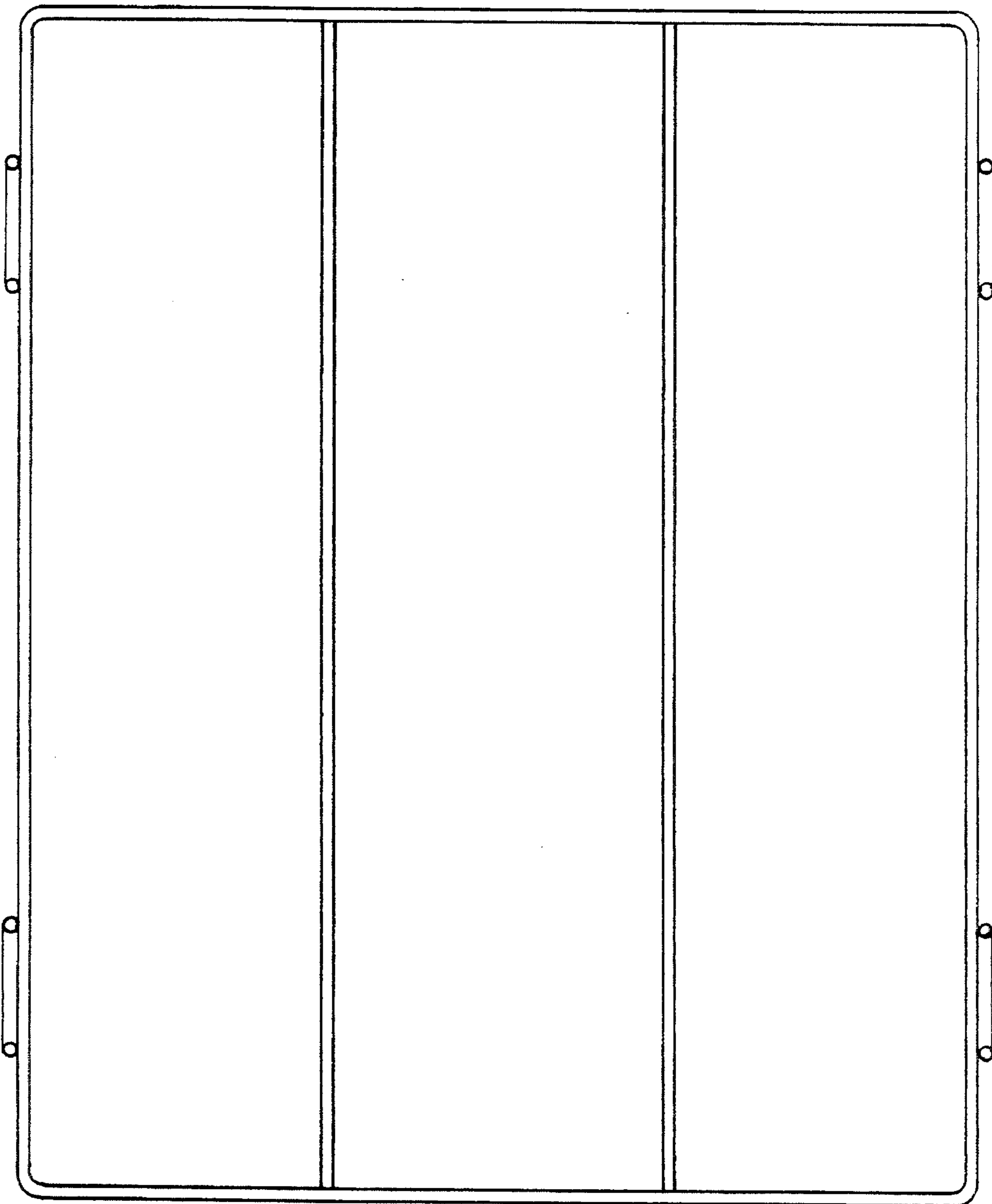

Fig. 5



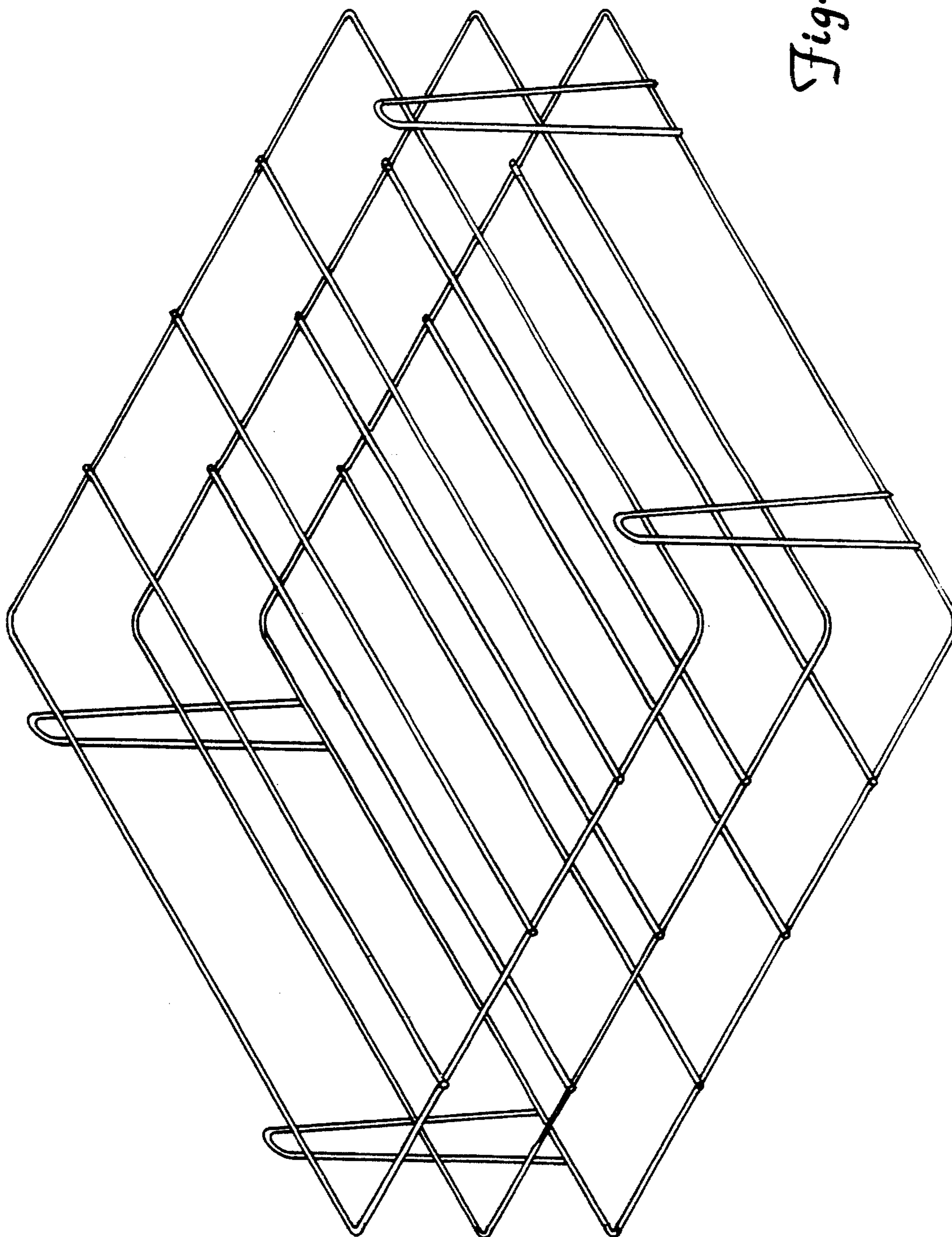

Fig. 6

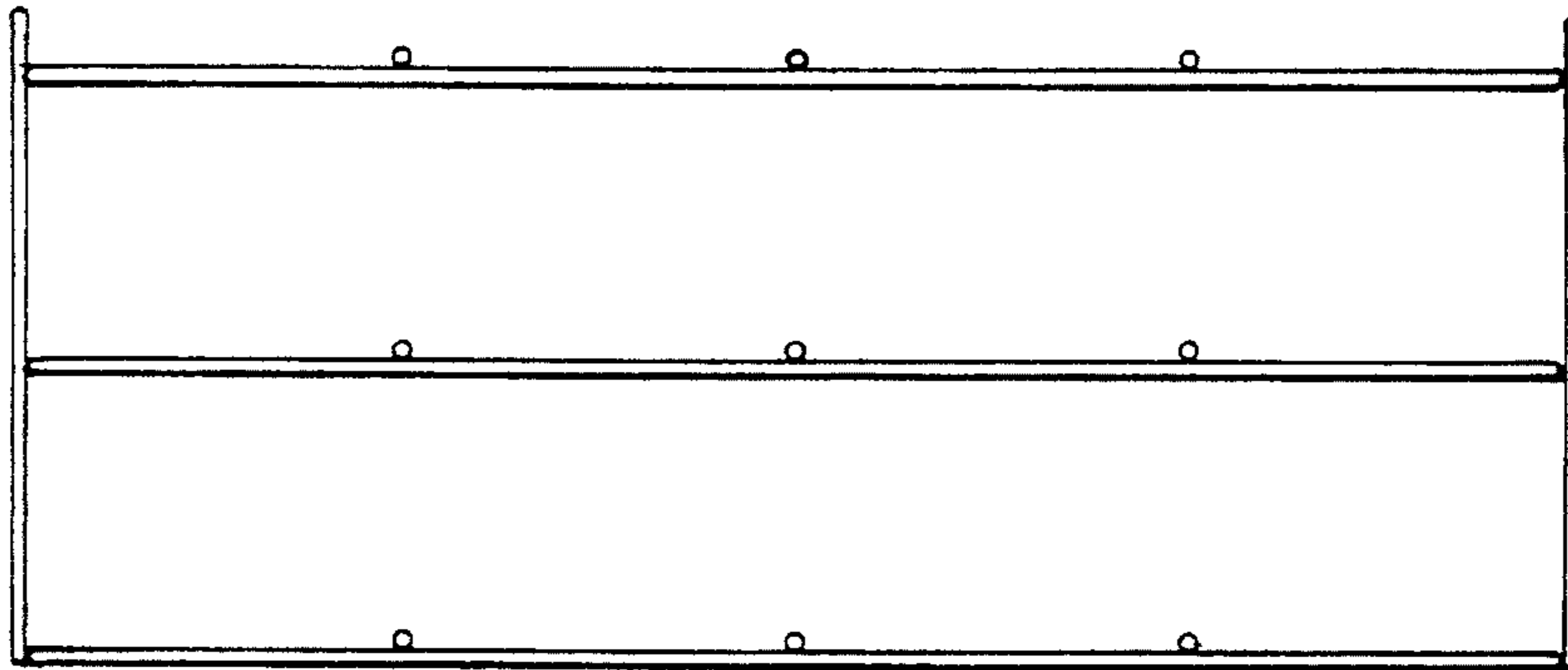

Fig. 7

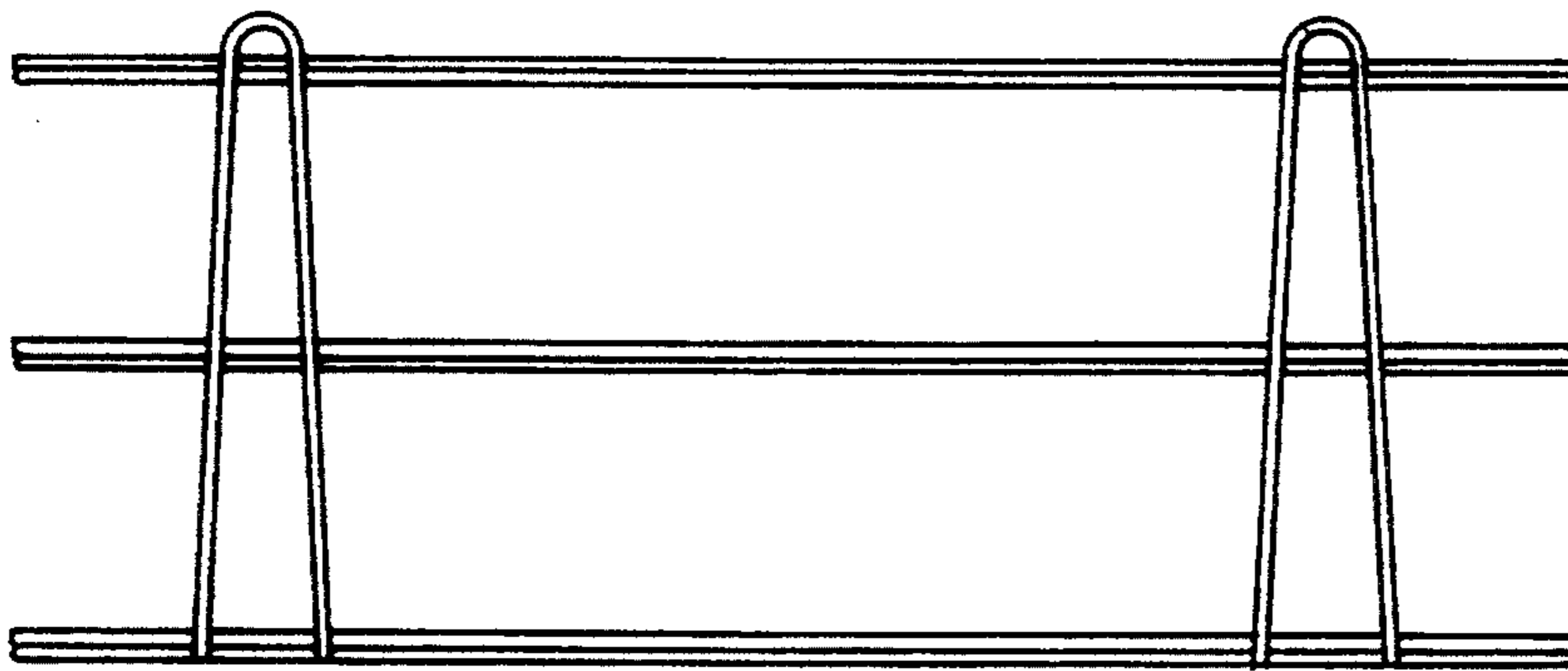

Fig. 8

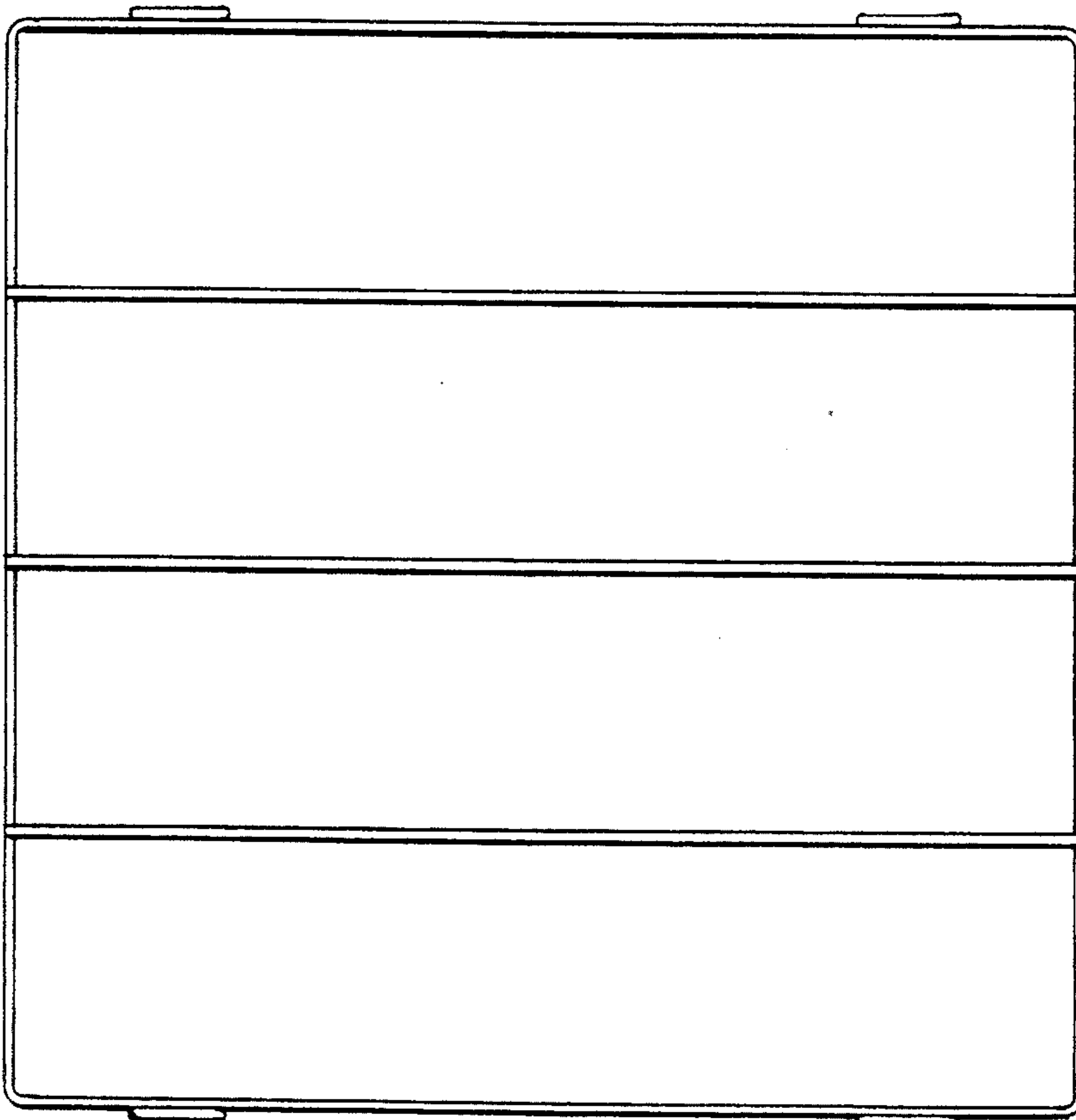

Fig. 9

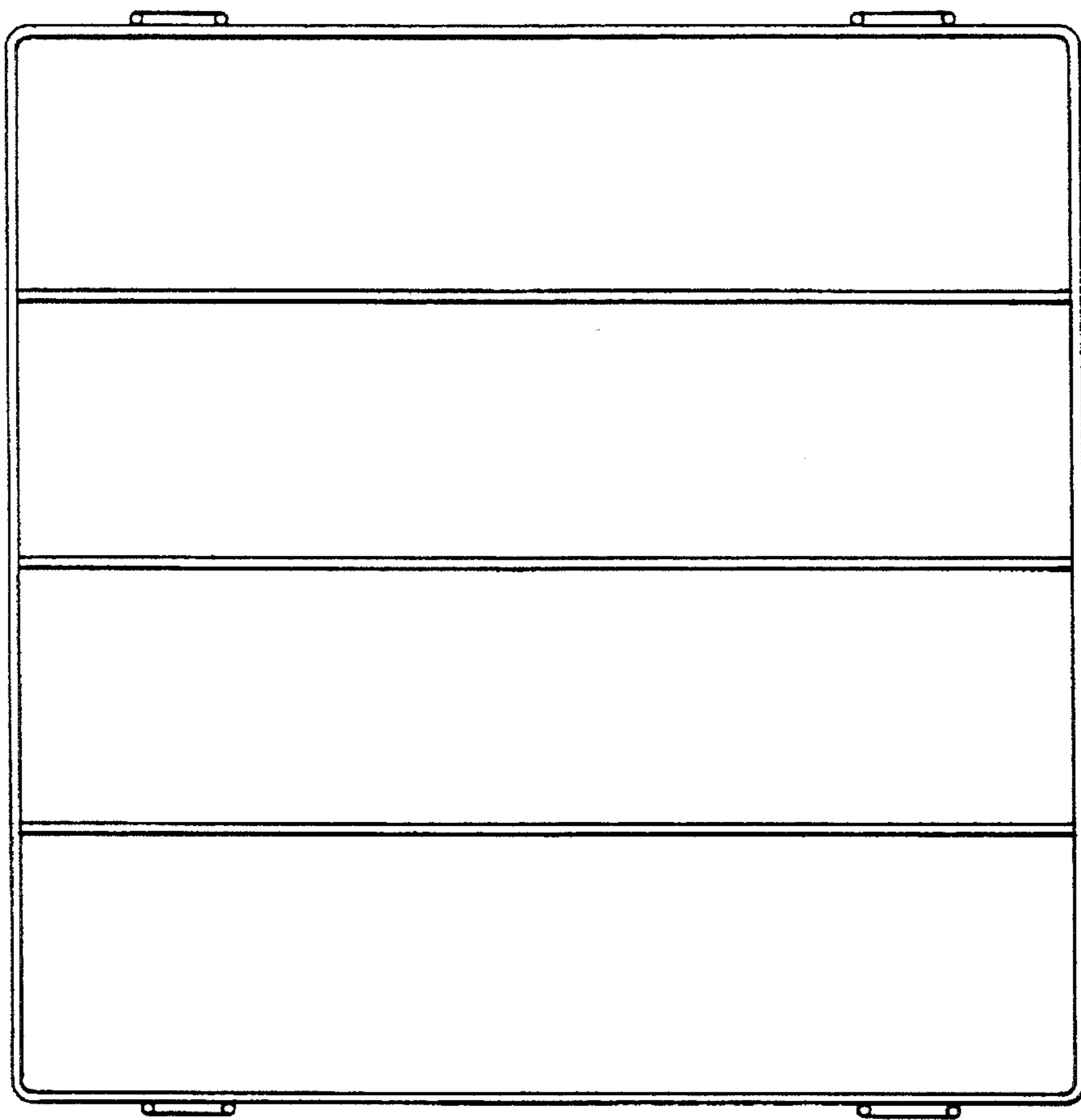

Fig. 10

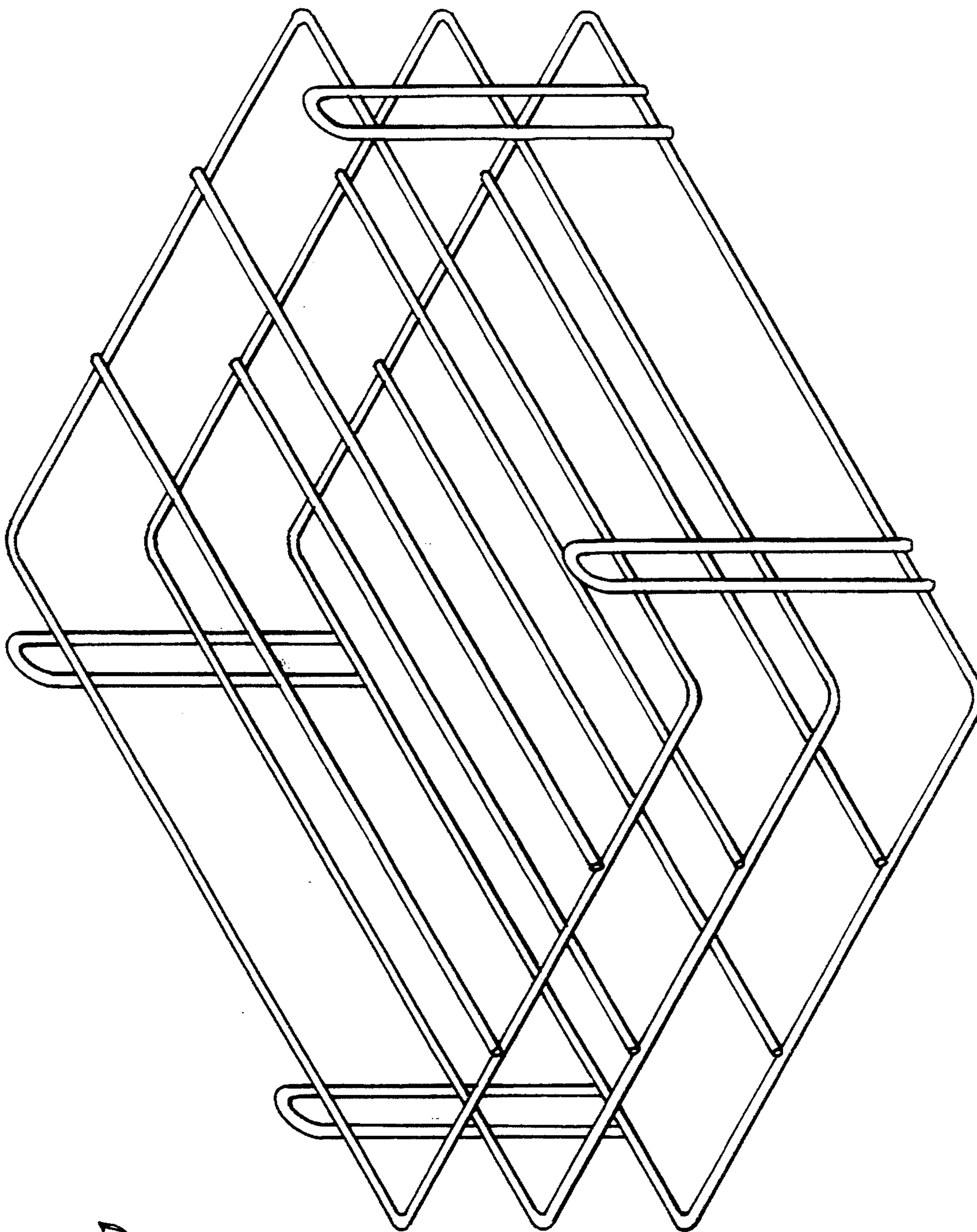

Fig. 11

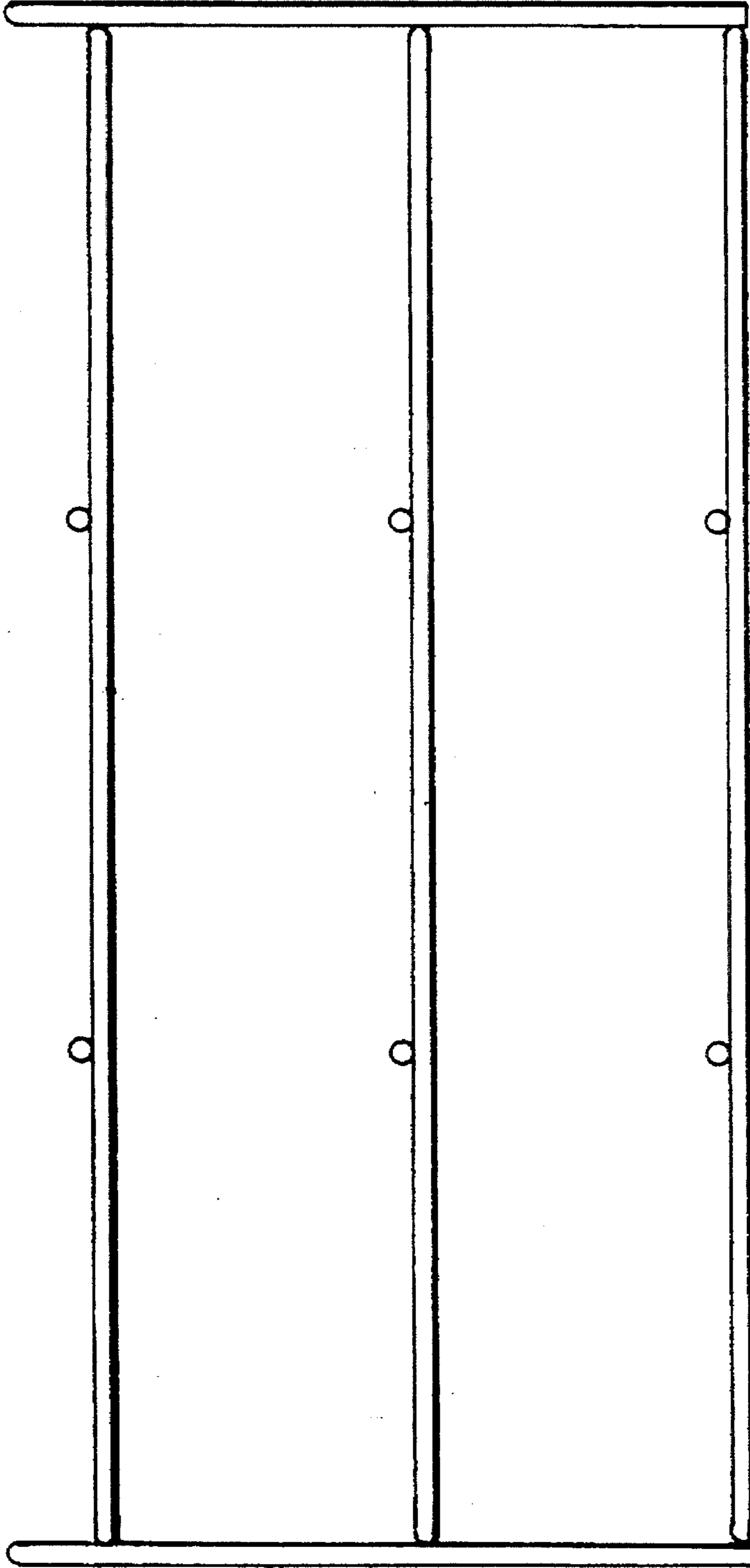

Fig. 12

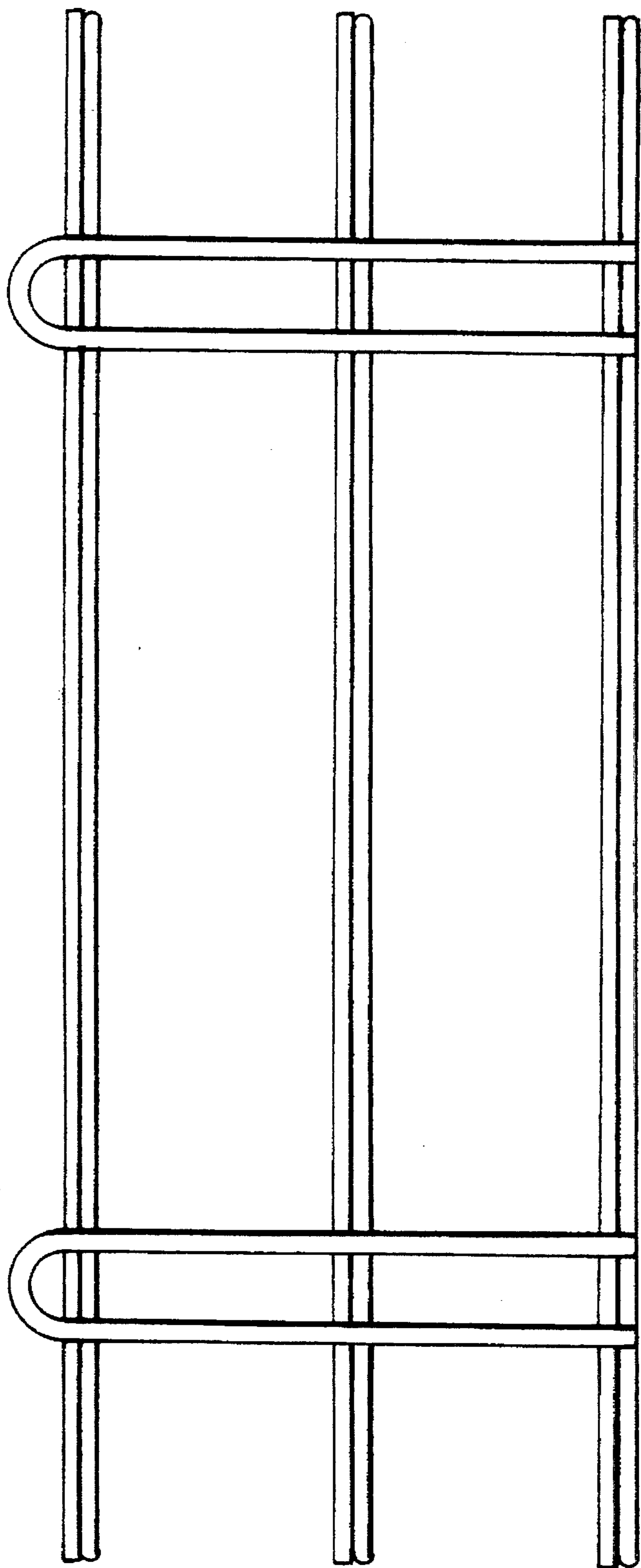

Fig. 13

Fig. 14

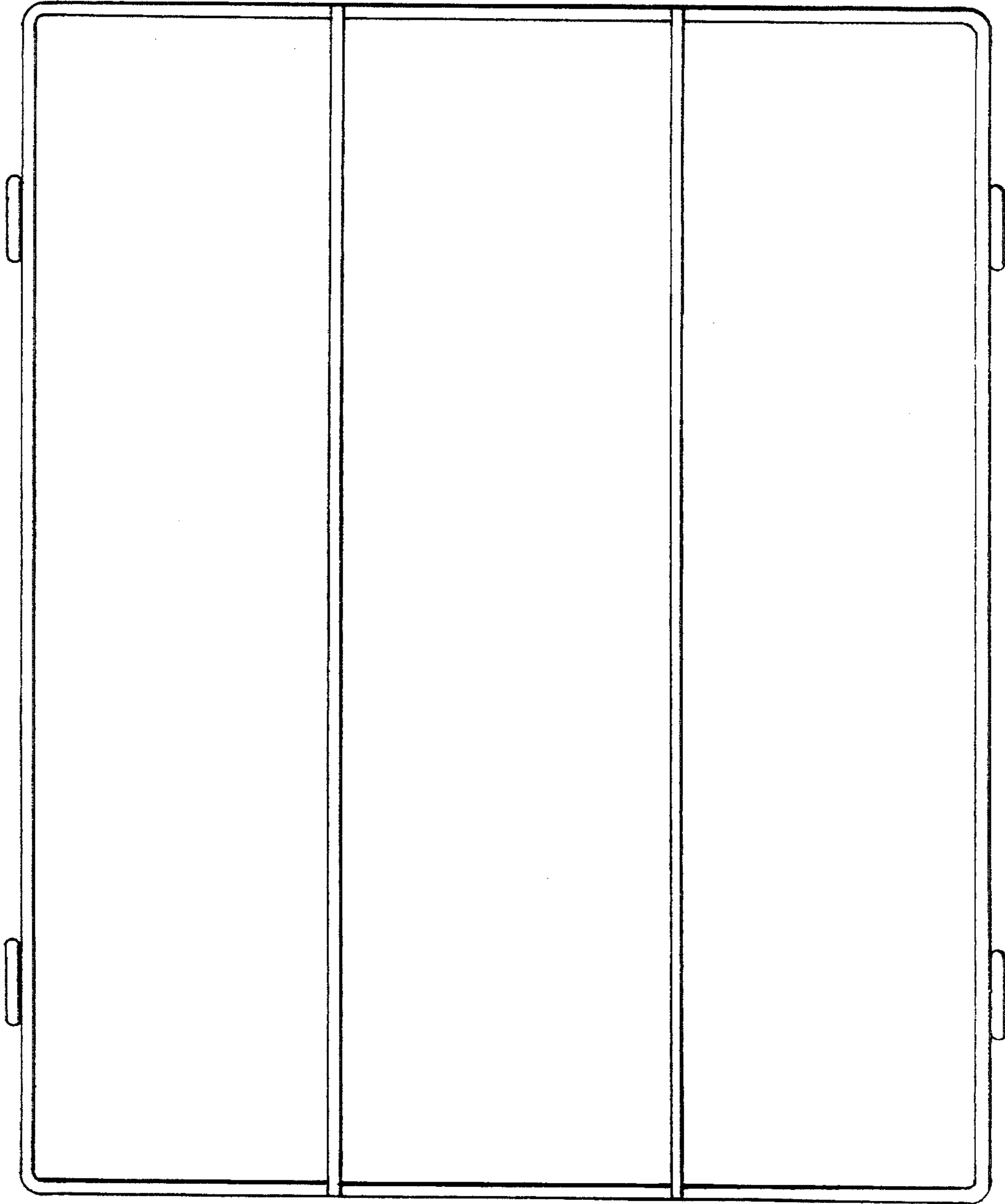

Fig. 15

