



US00D364264S

United States Patent [19] Sheer

[11] Patent Number: **Des. 364,264**

[45] Date of Patent: ****Nov. 21, 1995**

[54] **TOY HOCKEY HELMET**

D. 298,367 11/1988 Ball D29/106
D. 336,552 6/1993 Timms et al. D29/106

[76] Inventor: **Ronald Sheer**, Complete Athlete,
Shoppingtown Mall, Erie Blvd. & E.
Genesee St., Dewitt, N.Y. 13214

Primary Examiner—Ruth McInroy
Attorney, Agent, or Firm—Harris Beach & Wilcox

[**] Term: **14 Years**

[57] CLAIM

[21] Appl. No.: **13,889**

The ornamental design for a toy hockey helmet, as shown and described.

[22] Filed: **Oct. 5, 1993**

DESCRIPTION

[52] U.S. Cl. **D2/869**; D29/102; D29/106

[58] Field of Search D29/102-107;
2/2, 410-412, 6.6, 6.7, 414, 423-425, 9

FIG. 1 is a side elevational view of a toy hockey helmet, showing my new design;
FIG. 2 is a front elevational view;
FIG. 3 is a rear elevational view;
FIG. 4 is a top plan view;
FIG. 5 is a bottom plan view; and,
FIG. 6 is a sectional view thereof taken along lines 6—6 in FIG. 3.

[56] References Cited

U.S. PATENT DOCUMENTS

D. 217,894	6/1970	Mikita et al.	D29/106
D. 265,520	7/1982	Gooding	D29/102
D. 266,627	10/1982	Gooding	D29/102
D. 277,331	1/1985	Clement	D29/106
D. 295,902	5/1988	Foulkes	D29/106

1 Claim, 3 Drawing Sheets

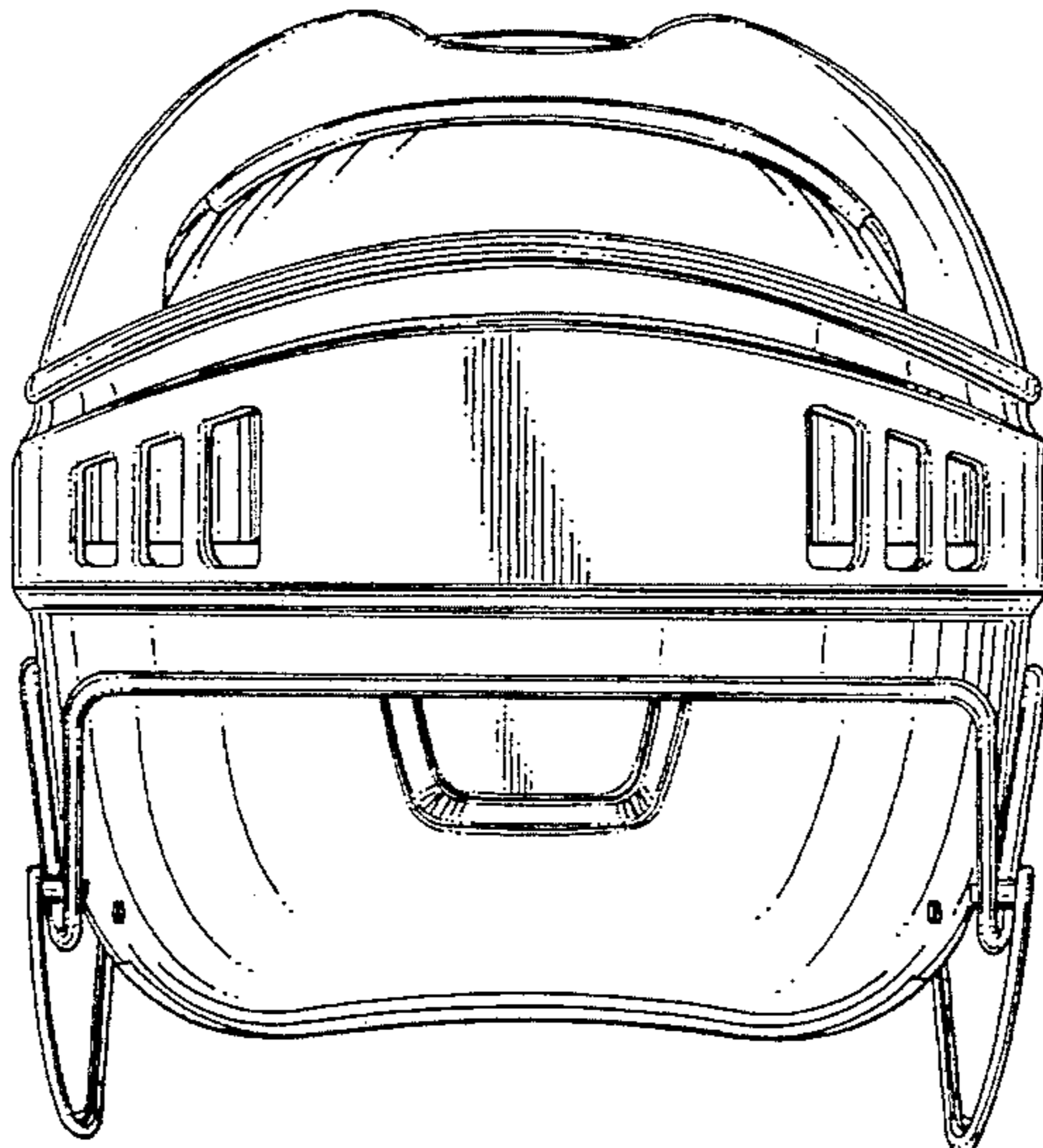
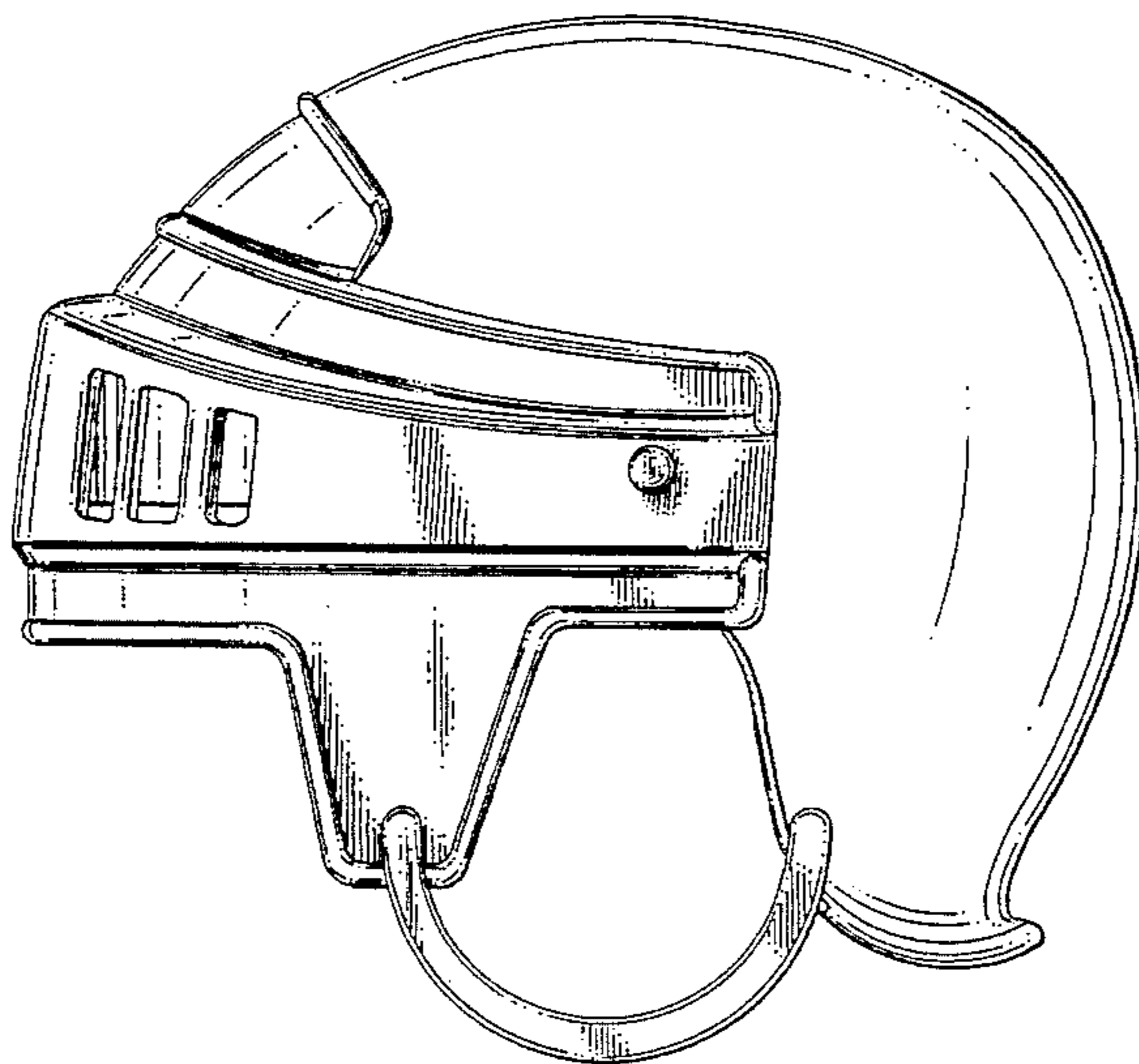

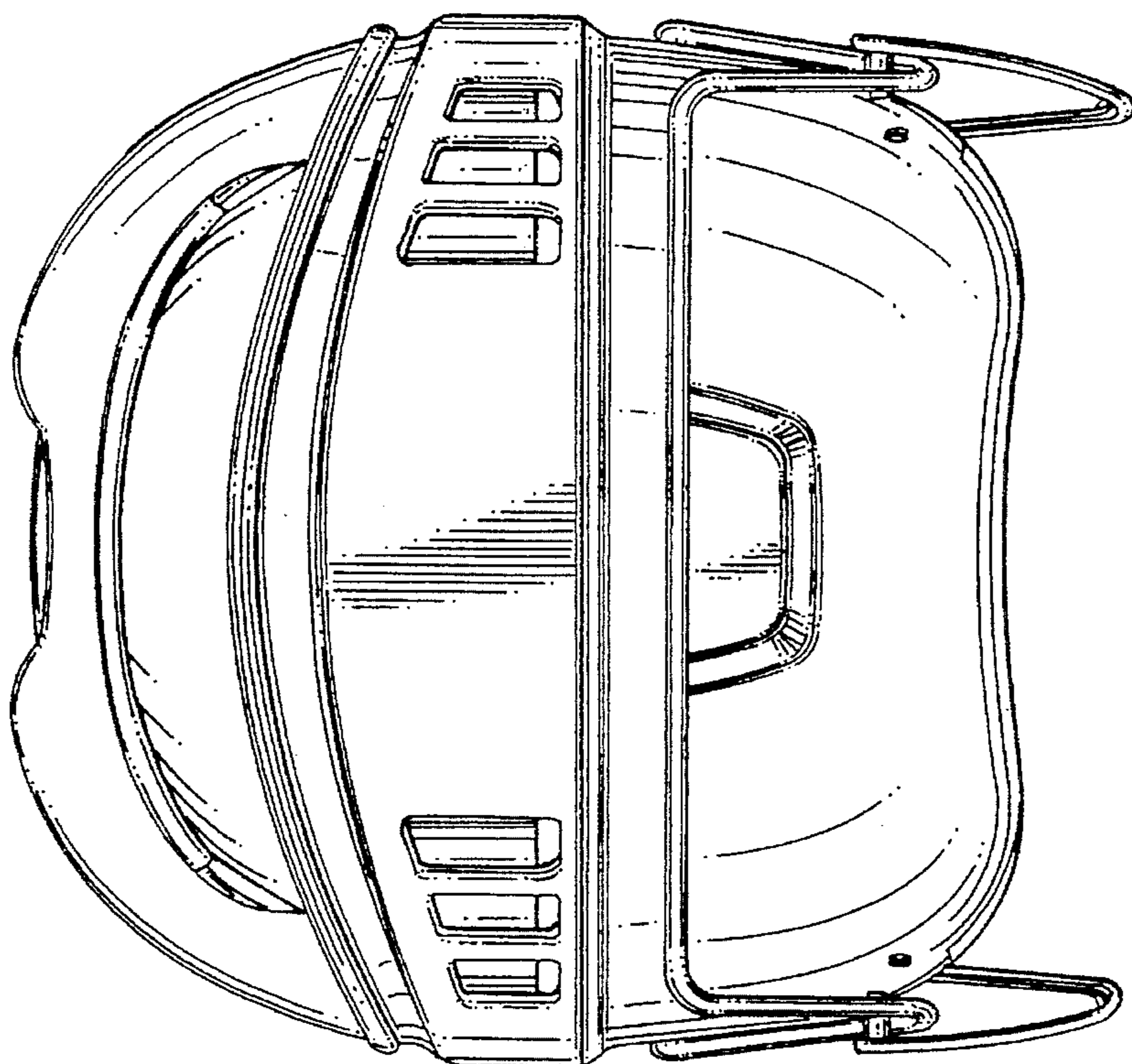

FIG. 2

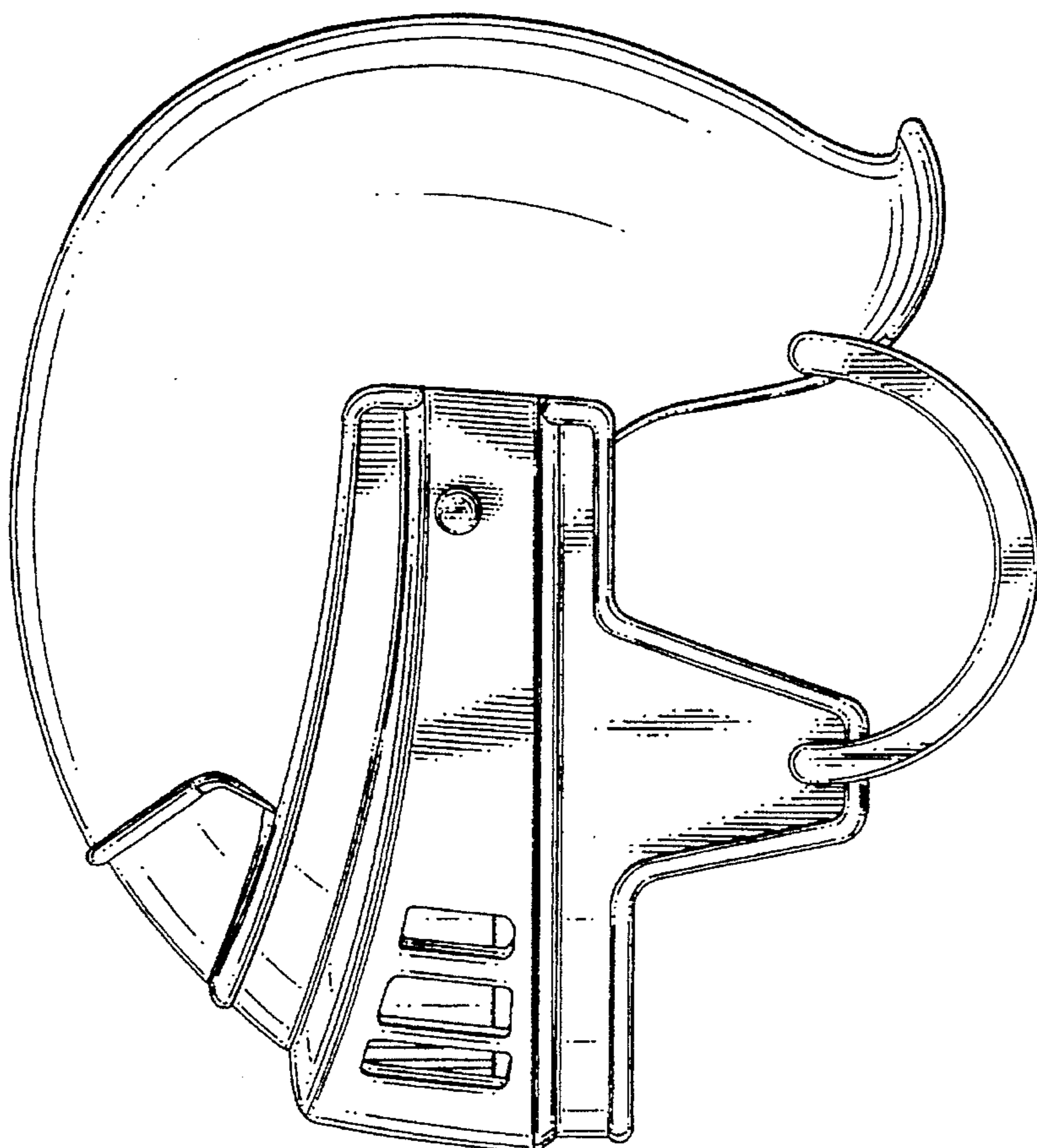

FIG. 1

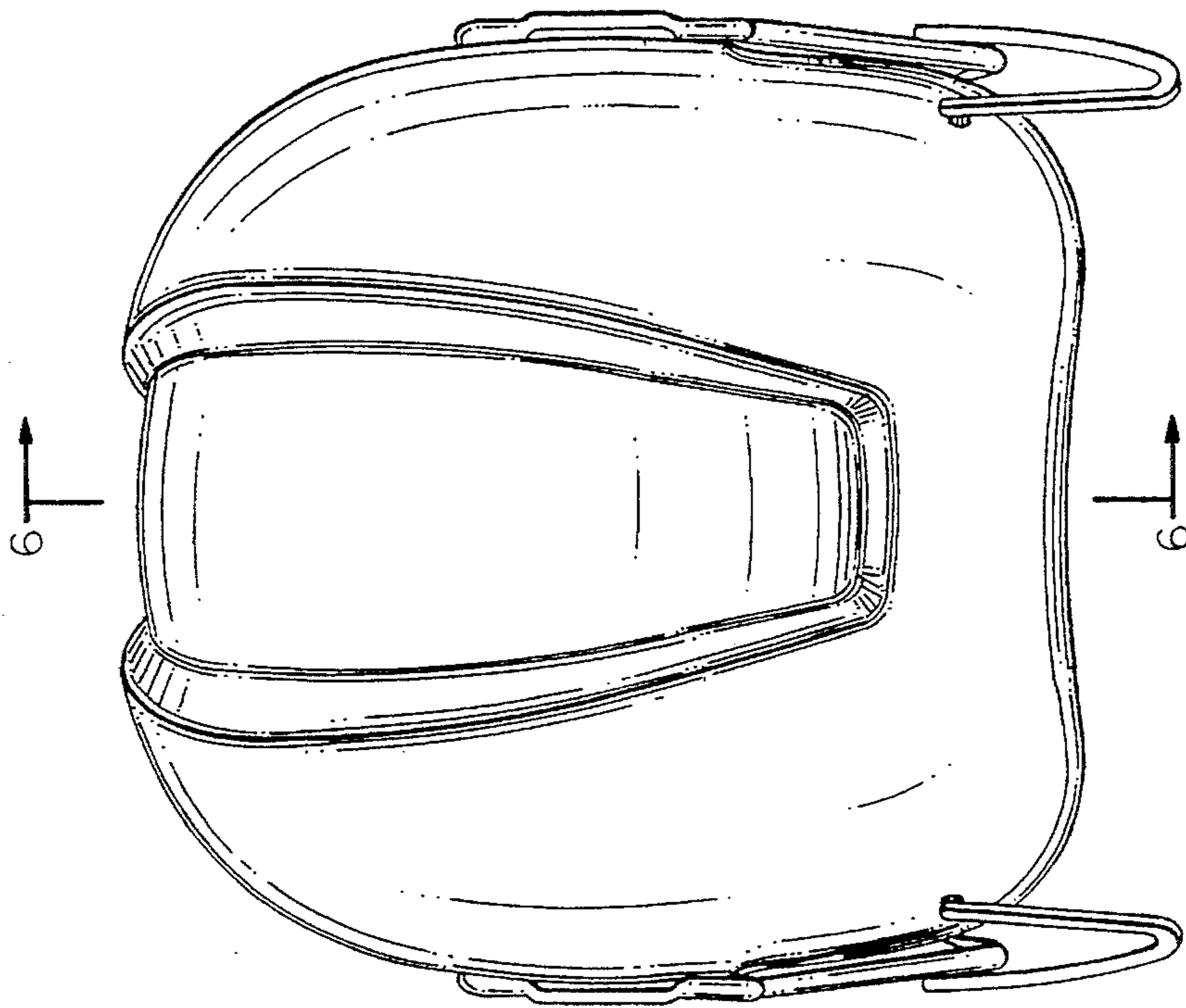

FIG. 3

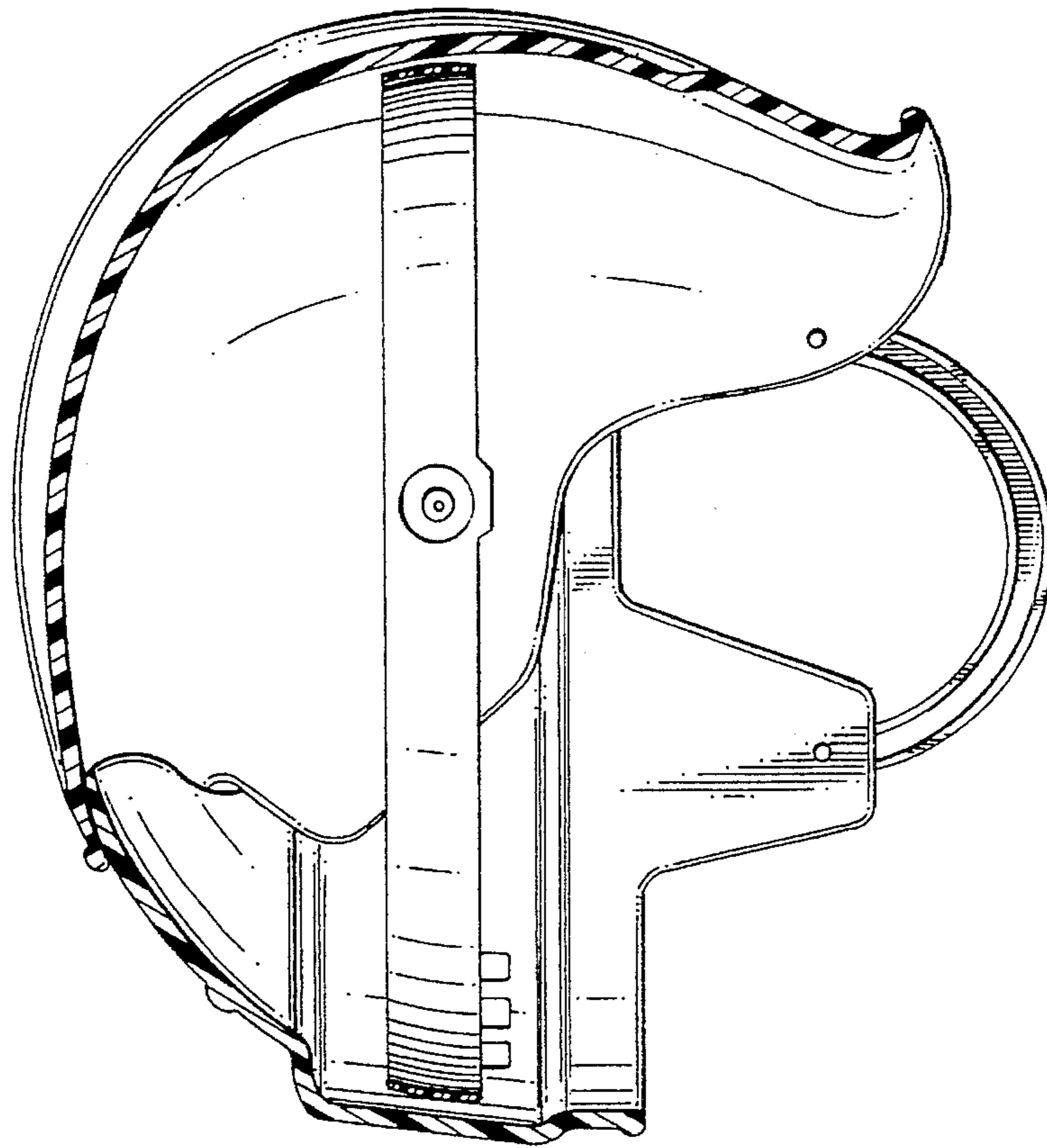

FIG. 6

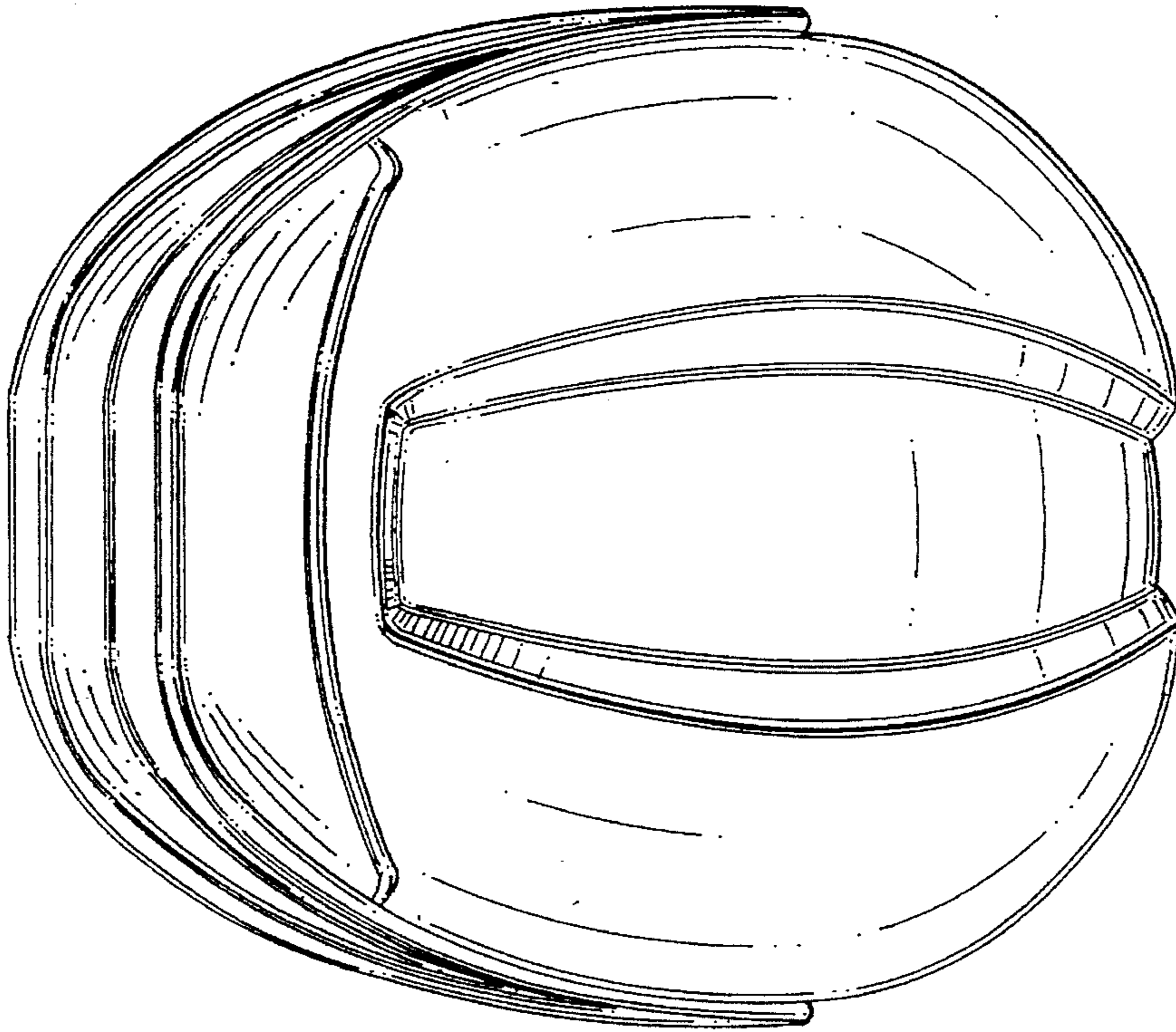

FIG. 4

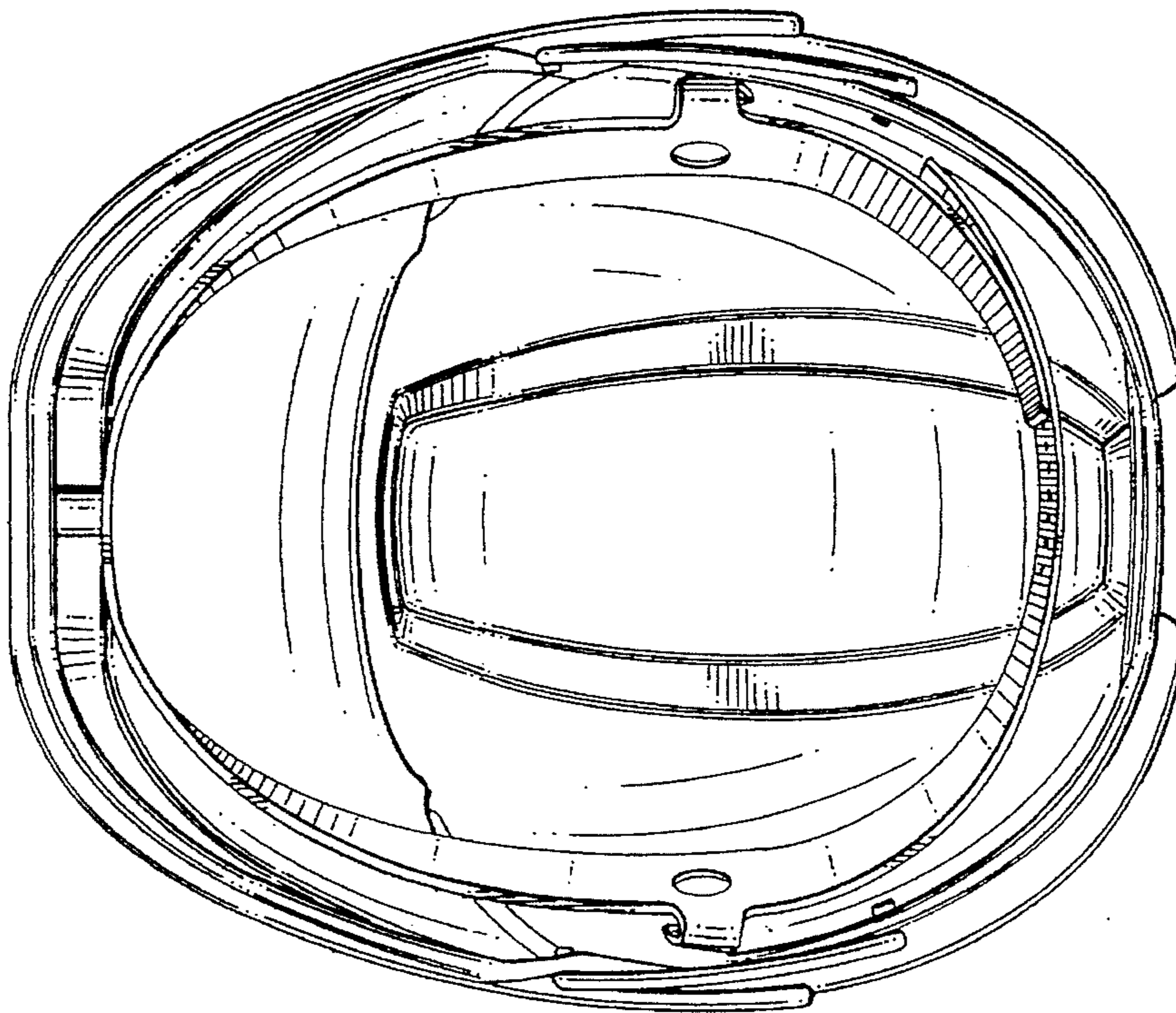

FIG. 5