



US00D364218S

United States Patent [19]

[11] Patent Number: **Des. 364,218**

Hill et al.

[45] Date of Patent: ****Nov. 14, 1995**

[54] FAUCET SPOUT

[75] Inventors: **Loran R. Hill**, Indianapolis; **Anthony G. Spangler**, Sheridan, both of Ind.

[73] Assignee: **Masco Corporation of Indiana**, Taylor, Mich.

[**] Term: **14 Years**

[21] Appl. No.: **15,154**

[22] Filed: **Nov. 9, 1993**

[52] U.S. Cl. **D23/255**

[58] Field of Search **D23/238-243, D23/250-258; 4/675, 676, 677, 678; 137/801**

[56] References Cited

U.S. PATENT DOCUMENTS

D. 251,794	5/1979	Smith .	
D. 254,801	4/1980	Santi .	
D. 267,110	11/1982	Arnolds .	
D. 268,608	4/1983	Wilcock .	
D. 276,259	11/1984	Miller .	
D. 278,270	4/1985	Nieman .	
D. 278,271	4/1985	Nieman .	
D. 279,598	6/1985	Rademacher .	
D. 280,010	8/1985	Miller et al. .	
D. 281,095	10/1985	Arnold et al. .	
D. 286,561	11/1986	Yost .	
D. 287,747	1/1987	Miller et al. .	
D. 288,835	3/1987	Yost .	
D. 290,992	6/1987	Hill et al. .	
D. 291,117	7/1987	Ryan .	
D. 295,550	5/1988	Yost .	
D. 295,551	5/1988	Yost .	
D. 318,906	8/1991	Spangler .	
D. 320,645	10/1991	Knapp et al. .	
D. 321,750	11/1991	Spangler .	
D. 339,853	9/1993	Higgins et al. .	
1,853,154	4/1932	Snyder	4/676
2,096,370	10/1937	Carmody	4/677 X
3,129,723	4/1964	Straka	4/676 X
4,998,555	3/1991	Barhydt, Sr. et al.	4/678 X

OTHER PUBLICATIONS

Delta The Way Water is Brought to Life Full Line Catalog 1991.

Delta HDF Commercial Products Catalog 1991.

Primary Examiner—Louis S. Zarfes
Assistant Examiner—Eric Watterson
Attorney, Agent, or Firm—Myron B. Kapustij; Malcolm L. Sutherland

[57] CLAIM

The ornamental design for a faucet spout, as shown and described.

DESCRIPTION

FIG. 1 is a front perspective view of a faucet spout showing our new design;

FIG. 2 is a rear perspective view thereof;

FIG. 3 is a top plan view thereof;

FIG. 4 is a front elevational view thereof;

FIG. 5 is a rear elevational view thereof;

FIG. 6 is a left side elevational view thereof, the right side being a mirror image;

FIG. 7 is a cross-sectional view, turned 90 degrees, taken along line 7—7 in FIG. 6;

FIG. 8 is a bottom plan view thereof;

FIG. 9 is a front perspective view of a second embodiment of the faucet spout;

FIG. 10 is a top plan view of FIG. 9;

FIG. 11 is a front elevational view of FIG. 9;

FIG. 12 is a left side elevational view of FIG. 9, the right side being a mirror image thereof;

FIG. 13 is a cross-sectional view, turned 90 degrees, taken along line 13—13 in FIG. 12; and,

FIG. 14 is a rear perspective view of FIG. 9.

The broken line showing of the aerator in FIG. 1 is for purposes of illustration only and forms no part of the claimed design.

1 Claim, 6 Drawing Sheets

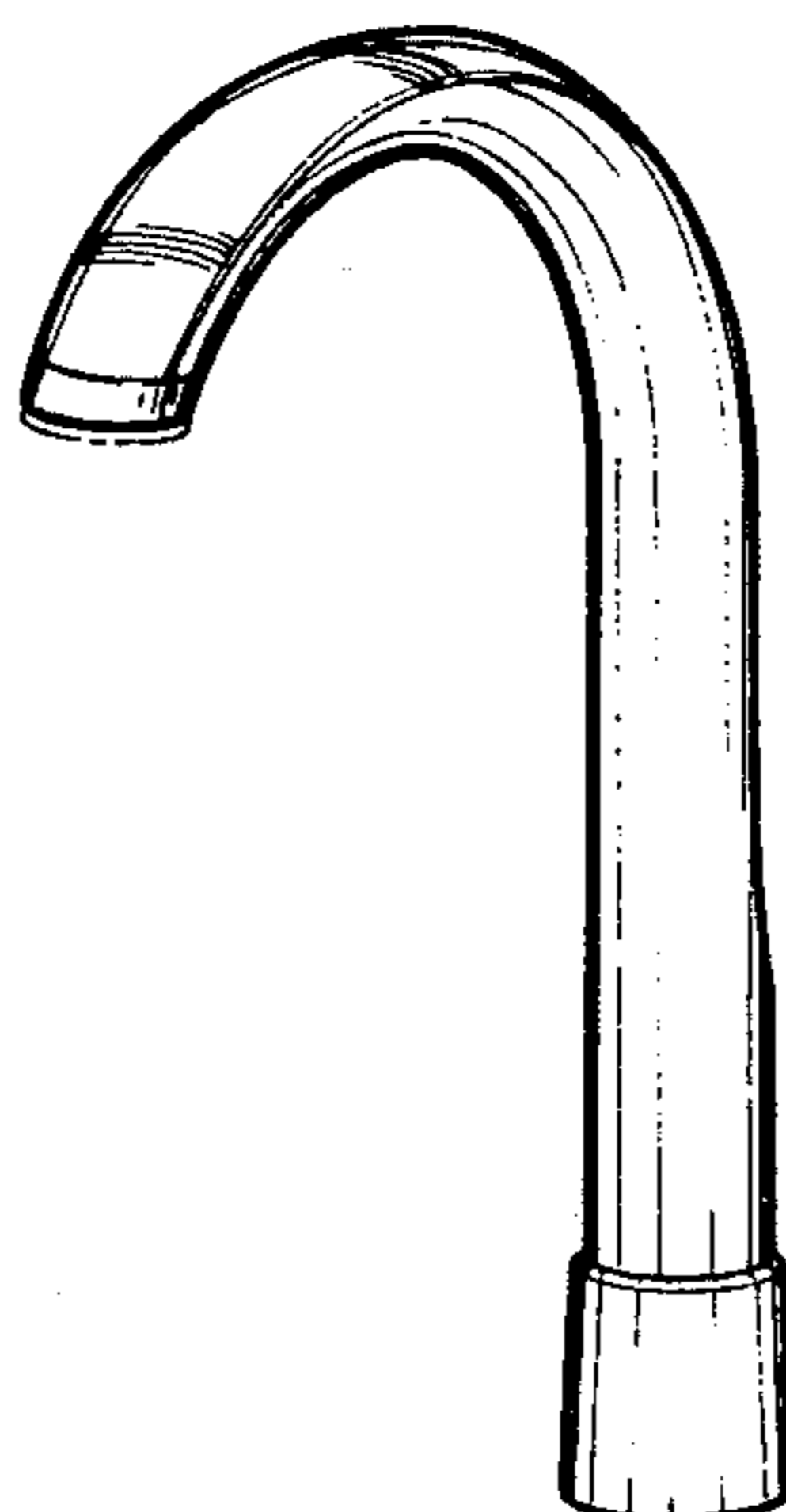

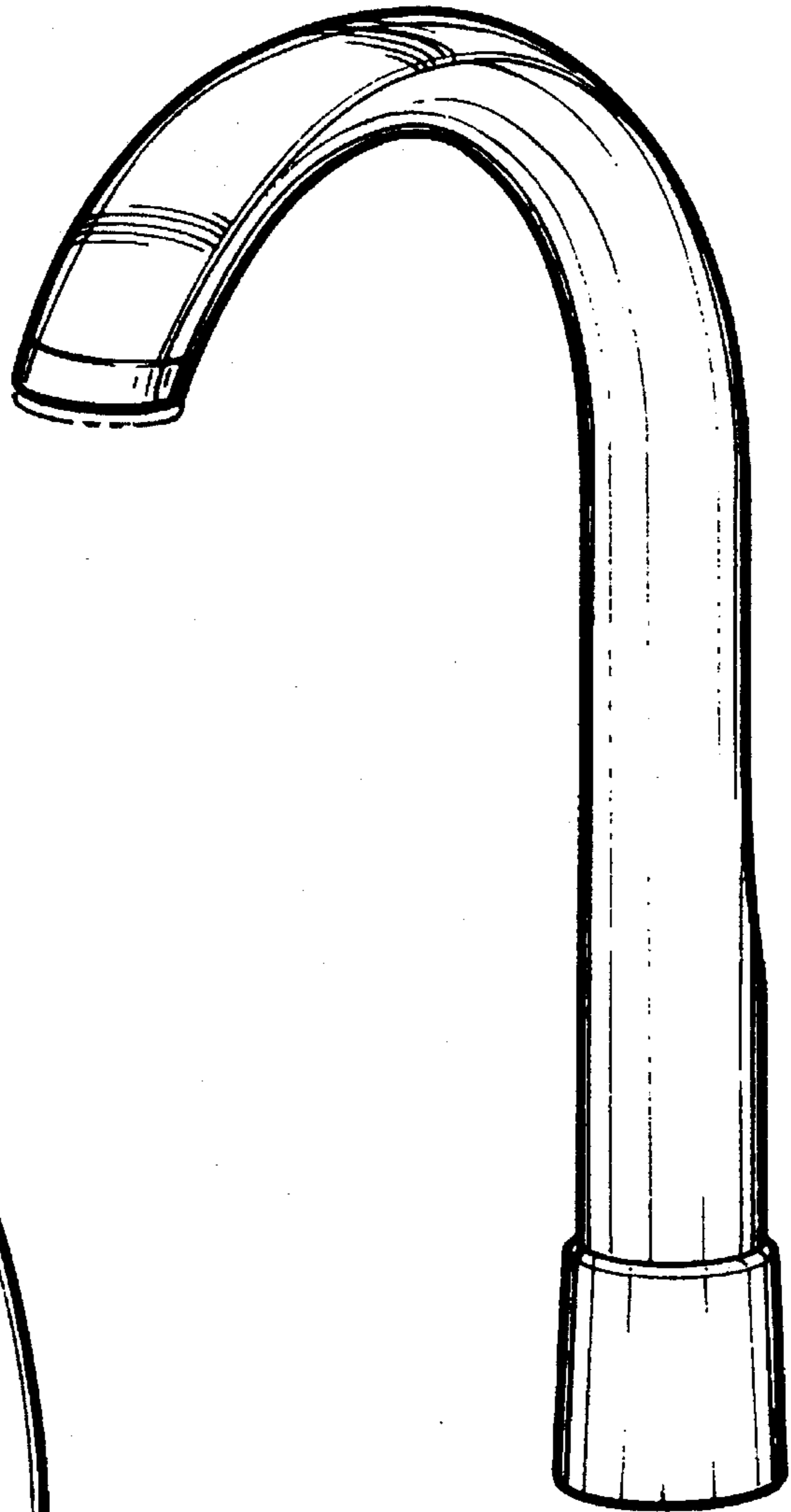

Fig - 1

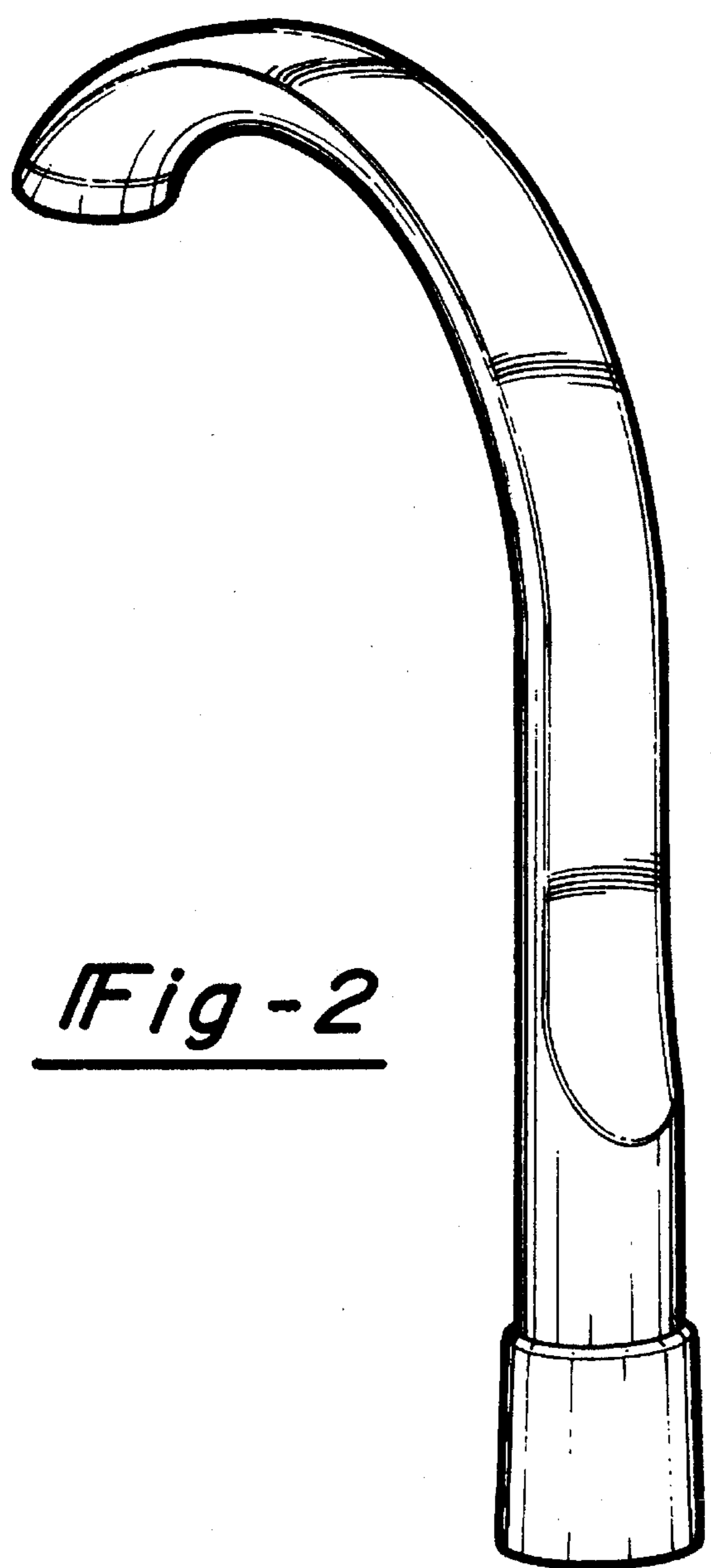

Fig - 2

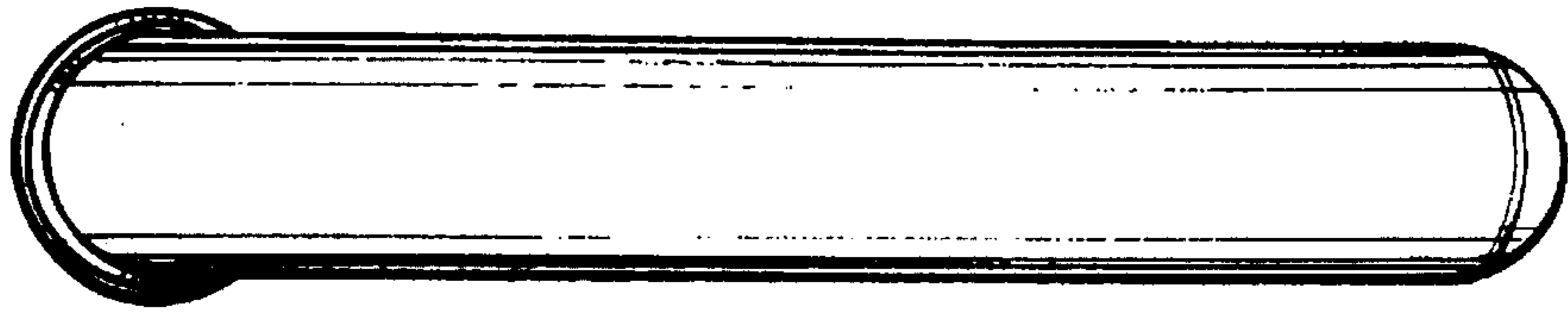

Fig - 3

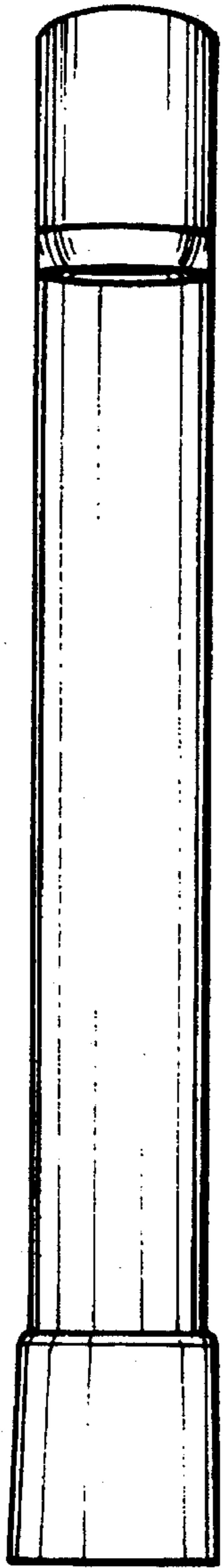

Fig - 4

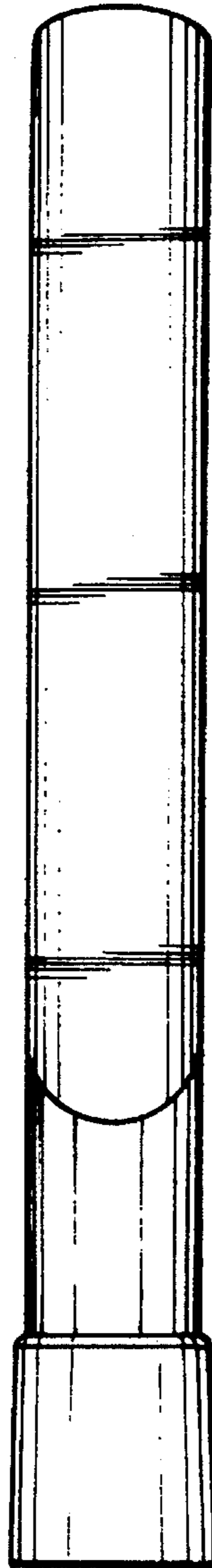

Fig - 5

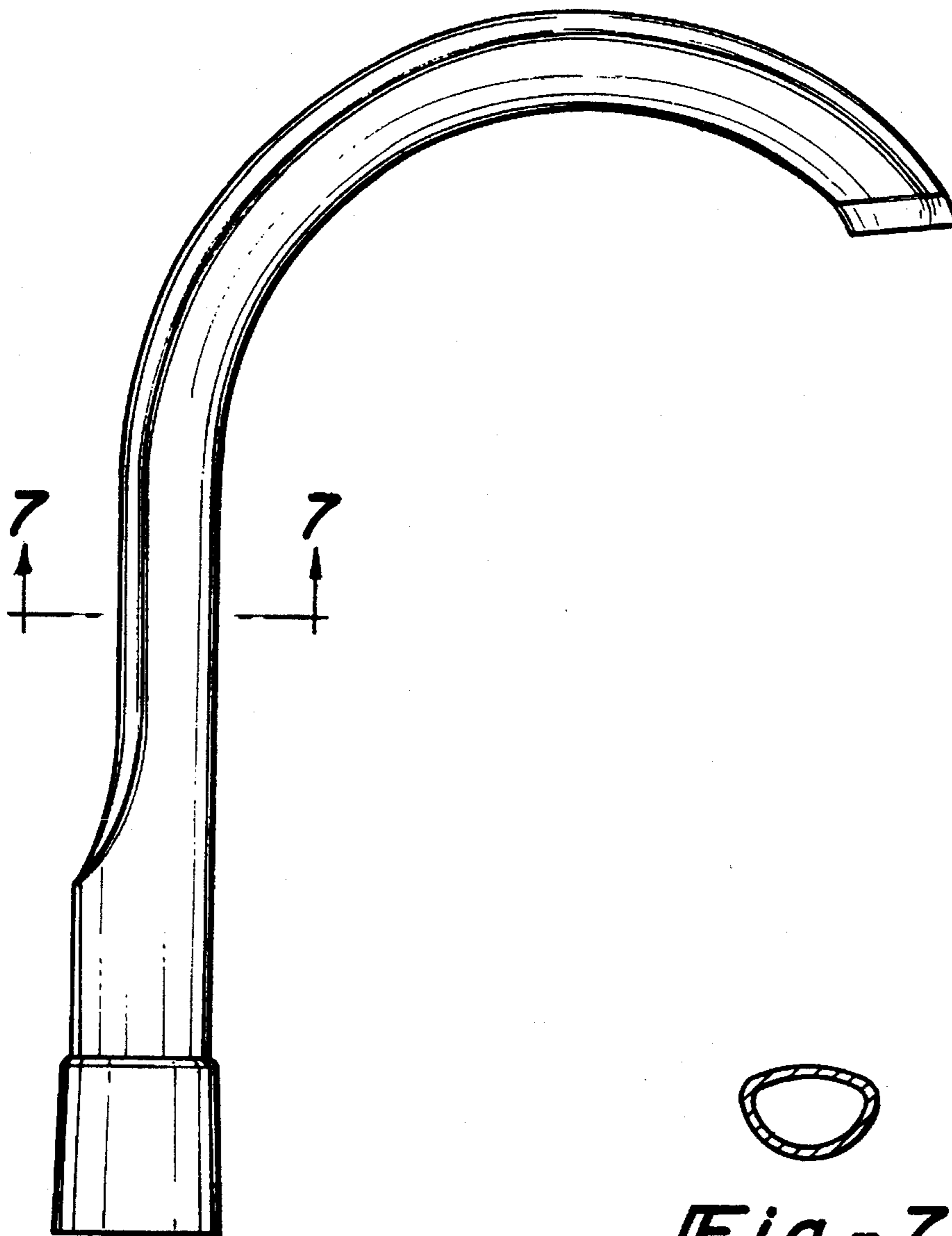

Fig - 6

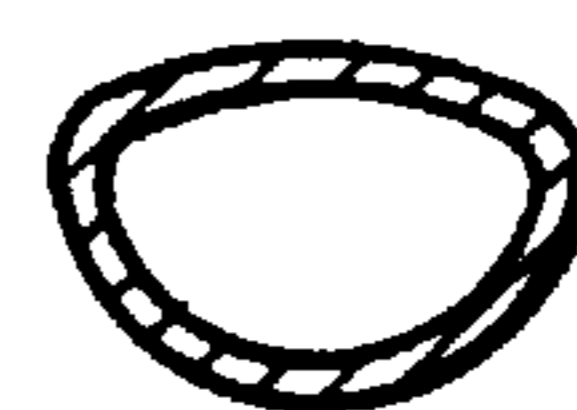

Fig - 7

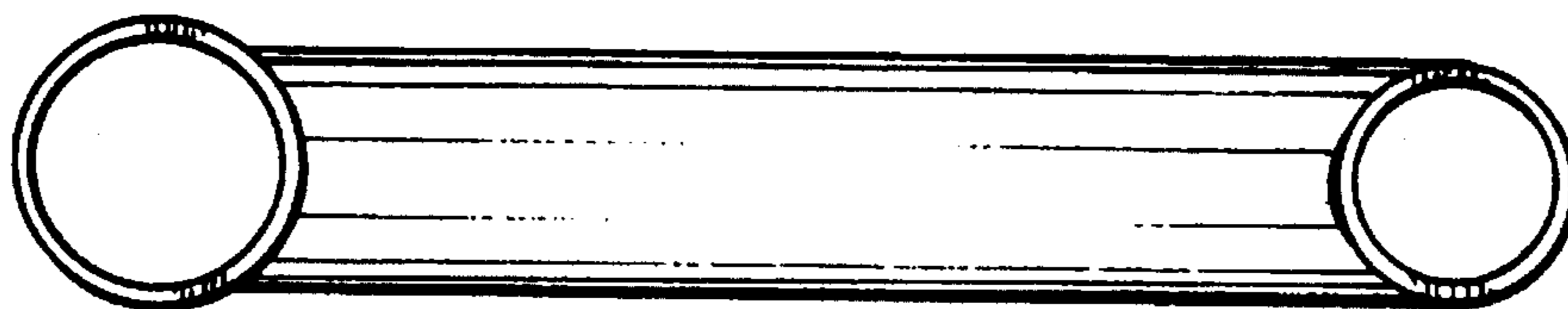

Fig - 8

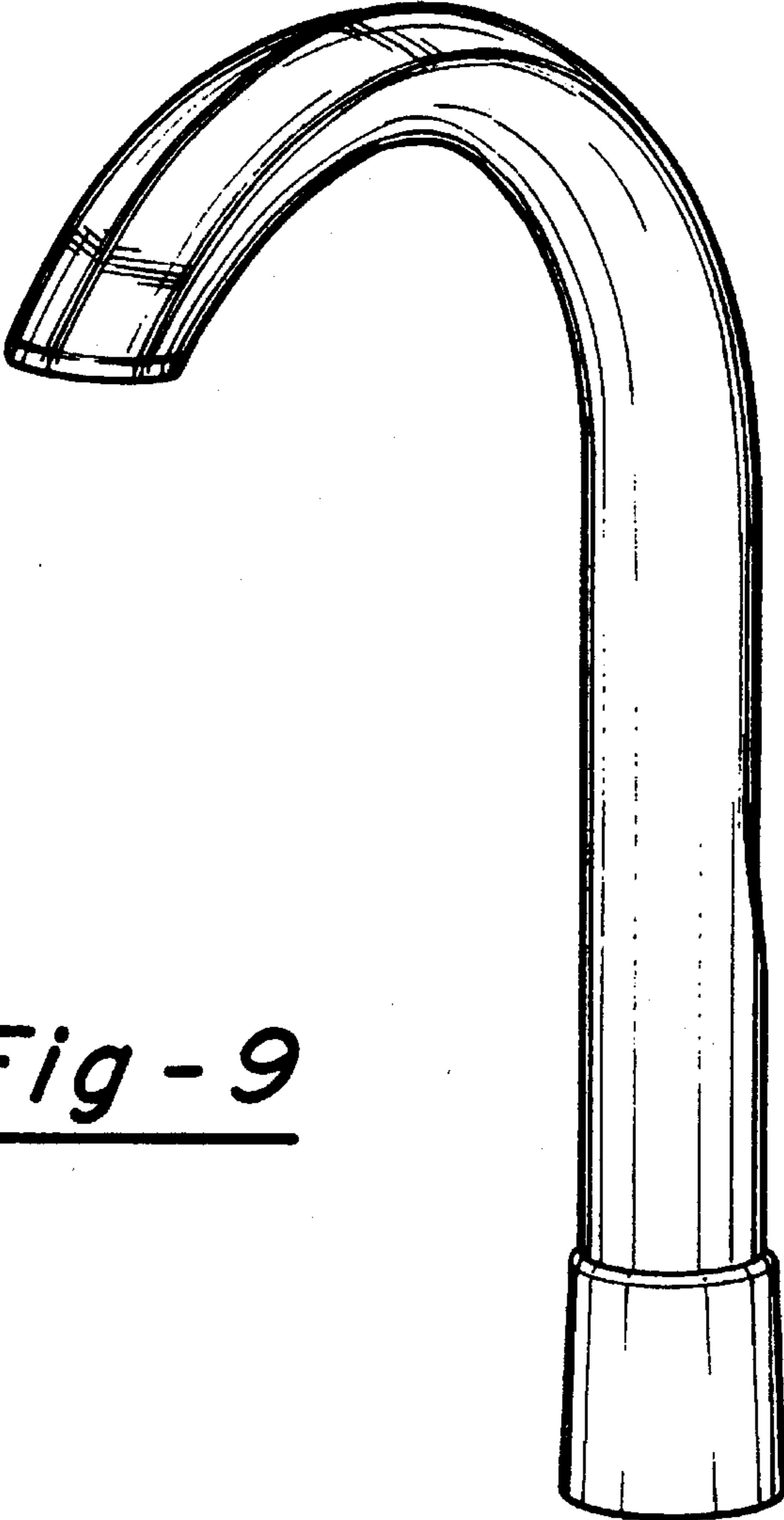

Fig - 9

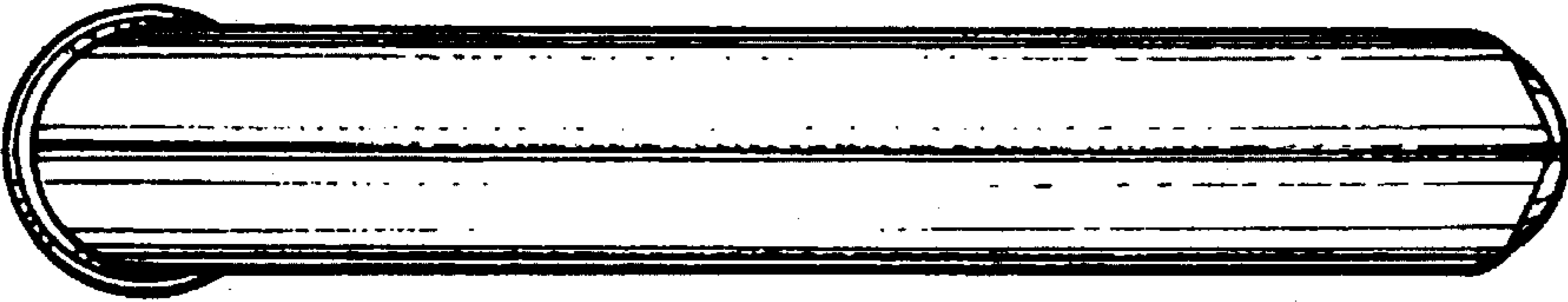

Fig - 10

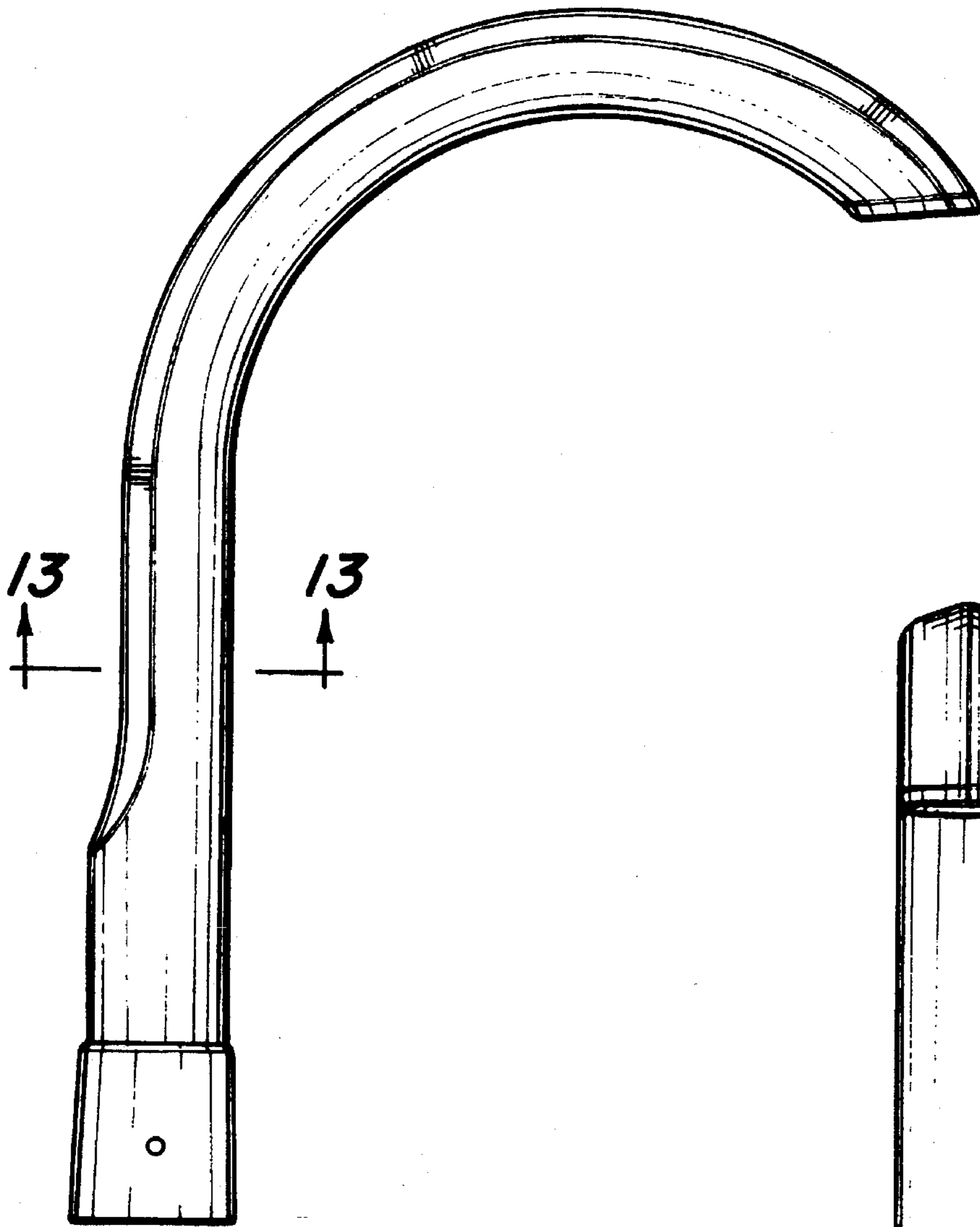

Fig-12

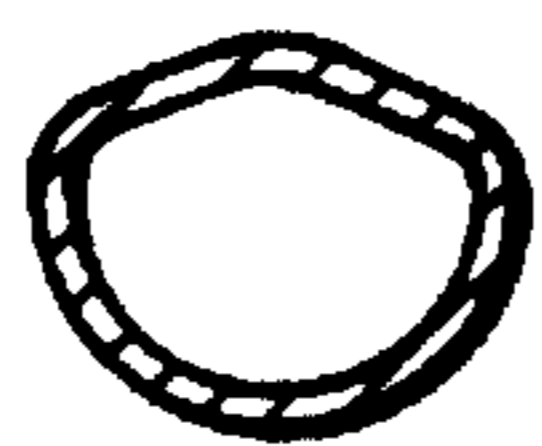

Fig-13

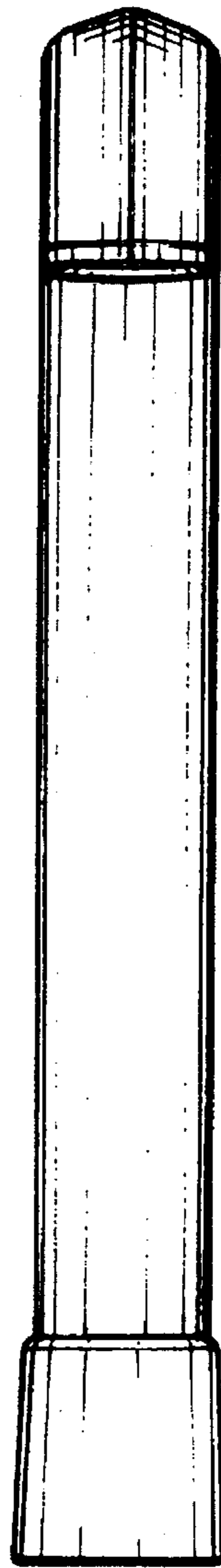

Fig-11

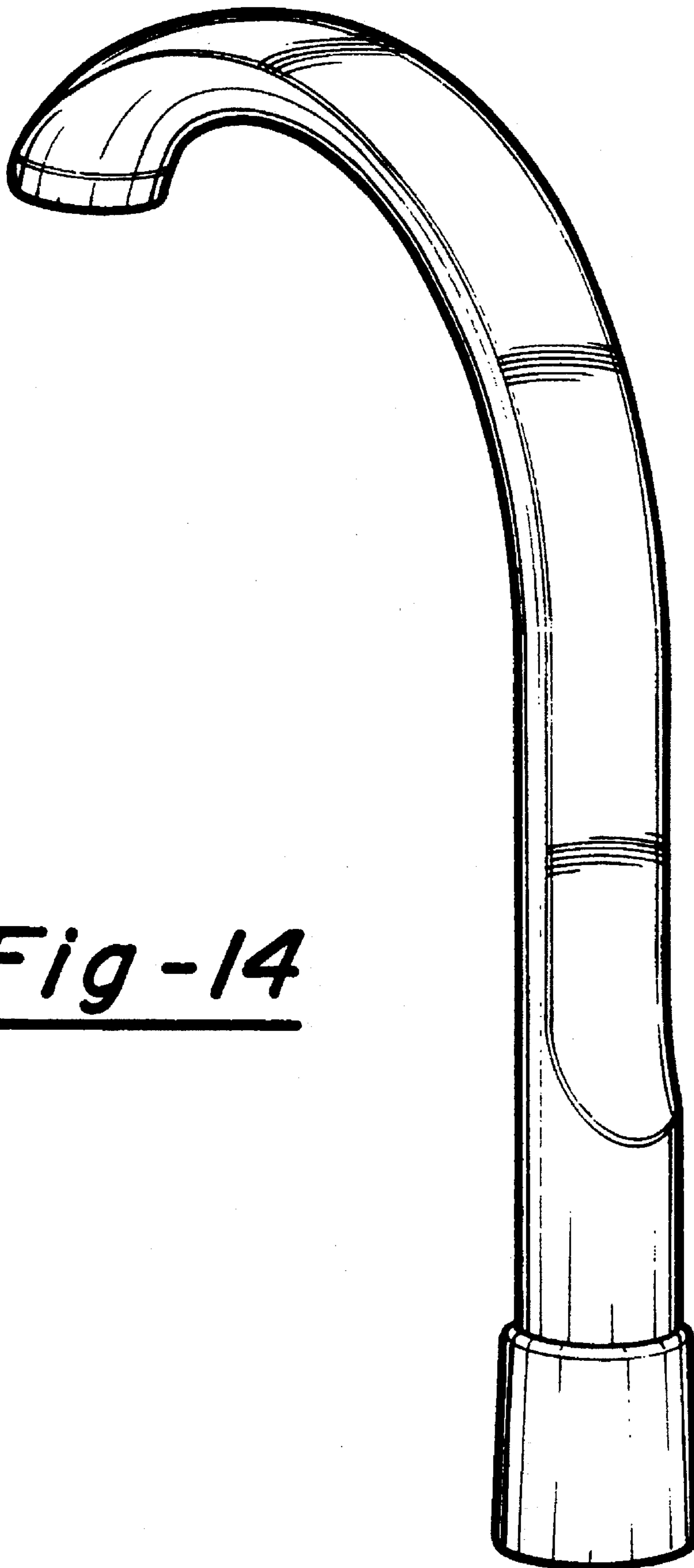

Fig - 14