



US00D364116S

United States Patent [19]

Weder et al.

[11] Patent Number: **Des. 364,116**

[45] Date of Patent: ****Nov. 14, 1995**

- [54] **FLOWER POT COVER**
- [75] Inventors: **Donald E. Weder; Joseph G. Straeter**, both of Highland, Ill.
- [73] Assignee: **Highland Supply Corporation**, Highland, Ill.
- [**] Term: **14 Years**
- [21] Appl. No.: **673**
- [22] Filed: **Oct. 20, 1992**

1,924,926	8/1932	Gray	65/53
1,951,642	8/1932	Augustin et al.	47/34
3,253,768	5/1966	Giesdal	D9/431 X
3,443,741	5/1969	Stockdale	D9/431 X
4,043,077	8/1977	Stonehocker	47/66
4,216,620	8/1980	Weder et al.	47/12
4,300,312	11/1981	Weder et al.	47/72
4,712,725	12/1987	Moore	229/8
4,733,521	3/1988	Weder et al.	53/580
5,076,011	12/1991	Stehouwer	47/72

Related U.S. Application Data

- [63] Continuation-in-part of Ser. No. 781,453, Oct. 21, 1991, Pat. No. Des. 348,634, which is a continuation-in-part of Ser. No. 617,454, Nov. 21, 1990, abandoned, and a continuation-in-part of Ser. No. 411,249, Sep. 22, 1989, Pat. No. Des. 358,113, and a continuation-in-part of Ser. No. 411,247, Sep. 22, 1989, and a continuation-in-part of Ser. No. 411,245, Sep. 22, 1989.
- [52] U.S. Cl. **D11/164; D11/155**
- [58] Field of Search D11/143, 149, D11/152-156, 164, 89, 90; 47/66, 72; 206/423; 215/100.5; 229/1.5 R, 1.5 B, 4.5, 87.01, 922, 930, 108, 108.1, 109, 110; 428/27, 35.1, 24, 542.6; D9/346, 428-431; D27/102, 133; D26/128-136; D19/96; D7/540, 584, 586, 587, 354

References Cited

U.S. PATENT DOCUMENTS

D. 239,192	3/1976	Wiles et al.	D35/3 A
D. 254,659	4/1980	Karotseris	D11/143
D. 289,024	3/1987	Vaughn	D11/164
D. 292,182	10/1987	Weder et al.	D11/164
D. 293,224	12/1987	Weder et al.	D11/164
D. 293,774	1/1988	Weder et al.	D11/164
D. 315,878	4/1991	Weder et al.	D11/164
D. 315,879	4/1991	Weder et al.	D11/164
D. 318,030	7/1991	Weder et al.	D11/164
D. 318,635	7/1991	Weder et al.	D11/164
D. 322,403	12/1991	Eaton	D9/429
D. 324,659	3/1992	Stehouwer	D11/164
D. 336,041	6/1993	Zama	D9/429
D. 348,634	7/1994	Weder et al.	D11/164

FOREIGN PATENT DOCUMENTS

2489126	3/1982	France
2603159	4/1988	France

OTHER PUBLICATIONS

- Exhibit A—Speed Cover ® Brochure—The Simple Solution . . . , ©1989.
- Exhibit A. "The Glass of Frederick Carder", copyright 1971 by P. V. Gardner, showing various styles of glass basket-like vases or containers.
- Primary Examiner*—Martie Thompson
- Assistant Examiner*—Jeffrey Asch
- Attorney, Agent, or Firm*—Dunlap & Coddling

[57] CLAIM

The ornamental design for a flower pot cover, as shown and described.

DESCRIPTION

FIG. 1 is a perspective view of our new flower pot cover design;

FIG. 2 is a side elevational view thereof;

FIG. 3 is a top plan view thereof;

FIG. 4 is a bottom plan view thereof;

FIG. 5 is a side elevational view of the design of FIG. 1, the only difference being in the horizontal angle of the skirt;

FIG. 6 is a side elevational view of the design of FIG. 1, the only difference being in the near vertical angle of the skirt;

FIG. 7 is a side elevational view of the design of FIG. 1, the only difference being in the downward angle of the skirt;

FIG. 8 is a side elevational view of a second embodiment of the design of FIG. 1, the only difference being in the height of the base;

(Description continued on next page.)

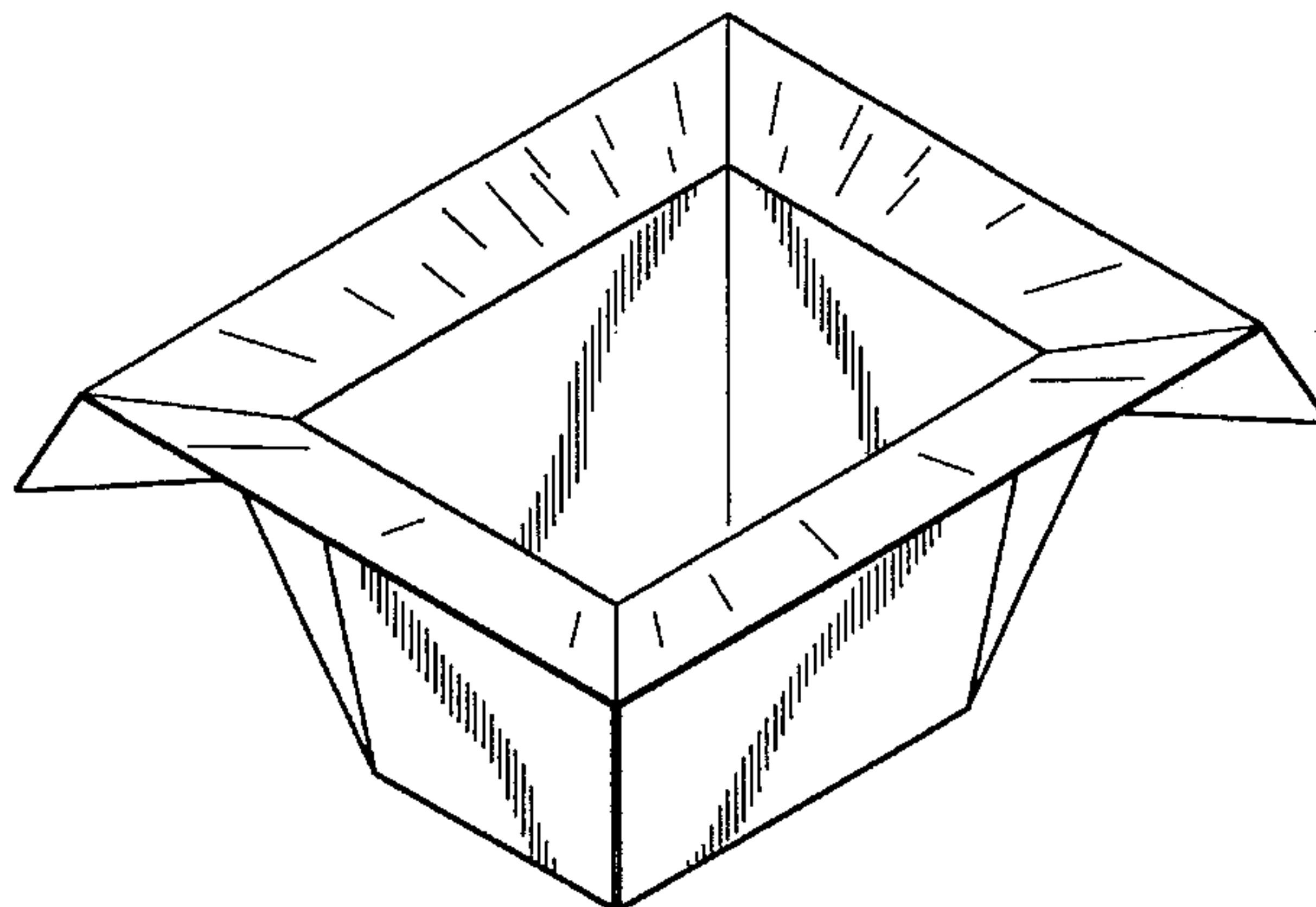
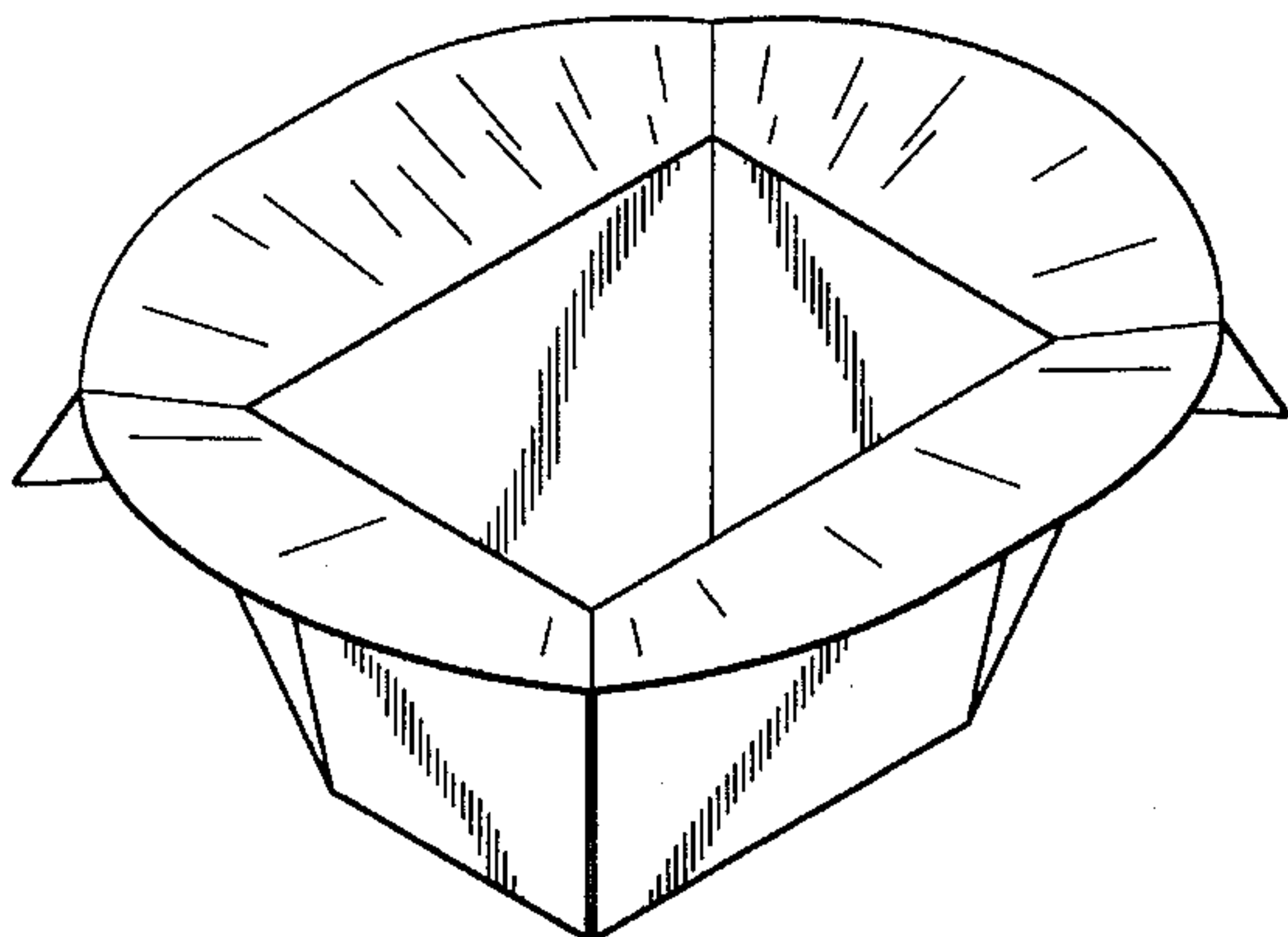

FIG. 9 is a side elevational view of a third embodiment of the design of FIG. 1, the only difference being in the height of the base;

FIG. 10 is a side elevational view of a fourth embodiment of the design of FIG. 1, the only difference being in the size of the skirt;

FIG. 11 is a side elevational view of a fifth embodiment of the design of FIG. 1, the only difference being in the size of the skirt;

FIG. 12 is a perspective view of a sixth embodiment of our new flower pot cover design;

FIG. 13 is a side elevational view thereof;

FIG. 14 is a top plan view thereof;

FIG. 15 is a bottom plan view thereof;

FIG. 16 is a side elevational view of the design of FIG. 12, the only difference being in the horizontal angle of the skirt;

FIG. 17 is a side elevational view of the design of FIG. 12, the only difference being in the near vertical angle of the skirt;

FIG. 18 is a side elevational view of the design of FIG. 12, the only difference being in the downward angle of the skirt;

FIG. 19 is a side elevational view of a seventh embodiment of the flower pot cover design, the only difference being in the height of the base;

FIG. 20 is a side elevational view of an eighth embodiment of the flower pot cover design, the only difference being in the height of the base;

FIG. 21 is a side elevational view of a ninth embodiment of the flower pot cover design, the only difference being in the size of the skirt;

FIG. 22 is a side elevational view of a tenth embodiment of the flower pot cover design, the only difference being in the size of the skirt;

FIG. 23 is a perspective view of an eleventh embodiment of our new flower pot cover design;

FIG. 24 is a side elevational view thereof;

FIG. 25 is a top plan view thereof;

FIG. 26 is a bottom plan view thereof;

FIG. 27 is a side elevational view of the design of FIG. 23, the only difference being in the horizontal angle of the skirt;

FIG. 28 is a side elevational view of the design of FIG. 23, the only difference being in the near vertical angle of the skirt;

FIG. 29 is a side elevational view of the design of FIG. 23, the only difference being in the downward angle of the skirt;

FIG. 30 is a side elevational view of a twelfth embodiment of the flower pot cover design, the only difference being in the height of the base;

FIG. 31 is a side elevational view of an thirteenth embodiment of the flower pot cover design, the only difference being in the height of the base;

FIG. 32 is a side elevational view of a fourteenth embodiment of the flower pot cover design, the only difference being in the size of the skirt;

FIG. 33 is a side elevational view of a fifteenth embodiment of the flower pot cover design, the only difference being in the size of the skirt;

FIG. 34 is a perspective view of an sixteenth embodiment of our new flower pot cover design;

FIG. 35 is a side elevational view thereof;

FIG. 36 is a top plan view thereof;

FIG. 37 is a bottom plan view thereof;

FIG. 38 is a side elevational view of the design of FIG. 34, the only difference being in the horizontal angle of the skirt;

FIG. 39 is a side elevational view of the design of FIG. 34, the only difference being in the near vertical angle of the

skirt;

FIG. 40 is a side elevational view of the design of FIG. 34, the only difference being in the downward angle of the skirt;

FIG. 41 is a side elevational view of a seventeenth embodiment of the flower pot cover design, the only difference being in the height of the base;

FIG. 42 is a side elevational view of an eighteenth embodiment of the flower pot cover design, the only difference being in the height of the base;

FIG. 43 is a side elevational view of a nineteenth embodiment of the flower pot cover design, the only difference being in the size of the skirt;

FIG. 44 is a side elevational view of a twentieth embodiment of the flower pot cover design, the only difference being in the size of the skirt;

FIG. 45 is a perspective view of an twenty-first embodiment of our new flower pot cover design;

FIG. 46 is a side elevational view thereof;

FIG. 47 is a top plan view thereof;

FIG. 48 is a bottom plan view thereof;

FIG. 49 is a side elevational view of the design of FIG. 45, the only difference being in the horizontal angle of the skirt;

FIG. 50 is a side elevational view of the design of FIG. 45, the only difference being in the near vertical angle of the skirt;

FIG. 51 is a side elevational view of the design of FIG. 45, the only difference being in the downward angle of the skirt;

FIG. 52 is a side elevational view of a twenty-second embodiment of the flower pot cover design, the only difference being in the height of the base;

FIG. 53 is a side elevational view of an twenty-third embodiment of the flower pot cover design, the only difference being in the height of the base;

FIG. 54 is a side elevational view of a twenty-fourth embodiment of the flower pot cover design, the only difference being in the size of the skirt;

FIG. 55 is a side elevational view of a twenty-fifth embodiment of the flower pot cover design, the only difference being in the size of the skirt;

FIG. 56 is a perspective view of an twenty-sixth embodiment of our new flower pot cover design;

FIG. 57 is a side elevational view thereof;

FIG. 58 is a top plan view thereof;

FIG. 59 is a bottom plan view thereof;

FIG. 60 is a side elevational view of the design of FIG. 56, the only difference being in the horizontal angle of the skirt;

FIG. 61 is a side elevational view of the design of FIG. 56, the only difference being in the near vertical angle of the skirt;

FIG. 62 is a side elevational view of the design of FIG. 56, the only difference being in the downward angle of the skirt;

FIG. 63 is a side elevational view of a twenty-seventh embodiment of the flower pot cover design, the only difference being in the height of the base;

FIG. 64 is a side elevational view of an twenty-eighth embodiment of the flower pot cover design, the only difference being in the height of the base;

FIG. 65 is a side elevational view of a twenty-ninth embodiment of the flower pot cover design, the only difference being in the size of the skirt; and,

FIG. 66 is a side elevational view of a thirtieth embodiment of the flower pot cover design, the only difference being in the size of the skirt.

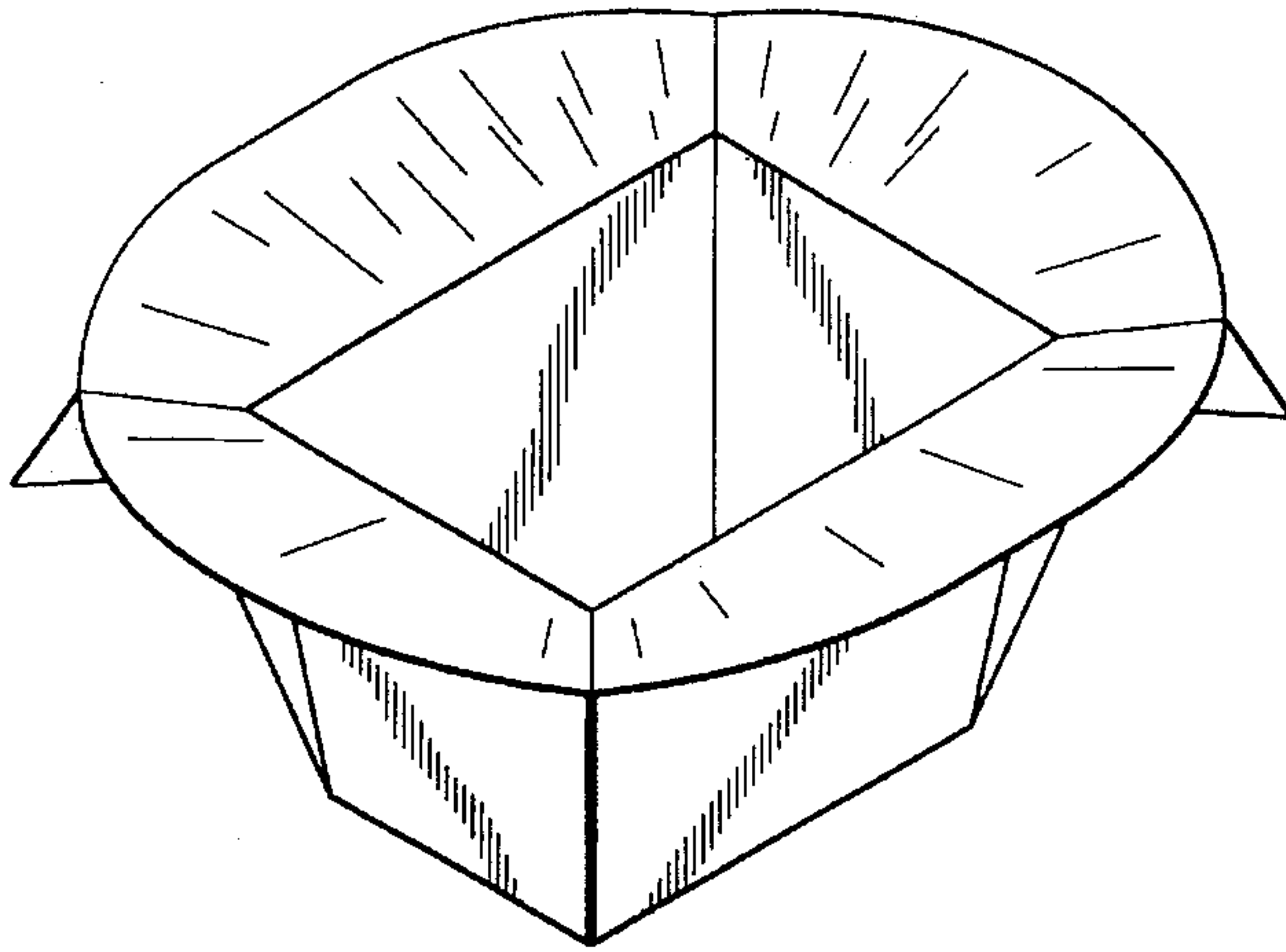

FIG. 1

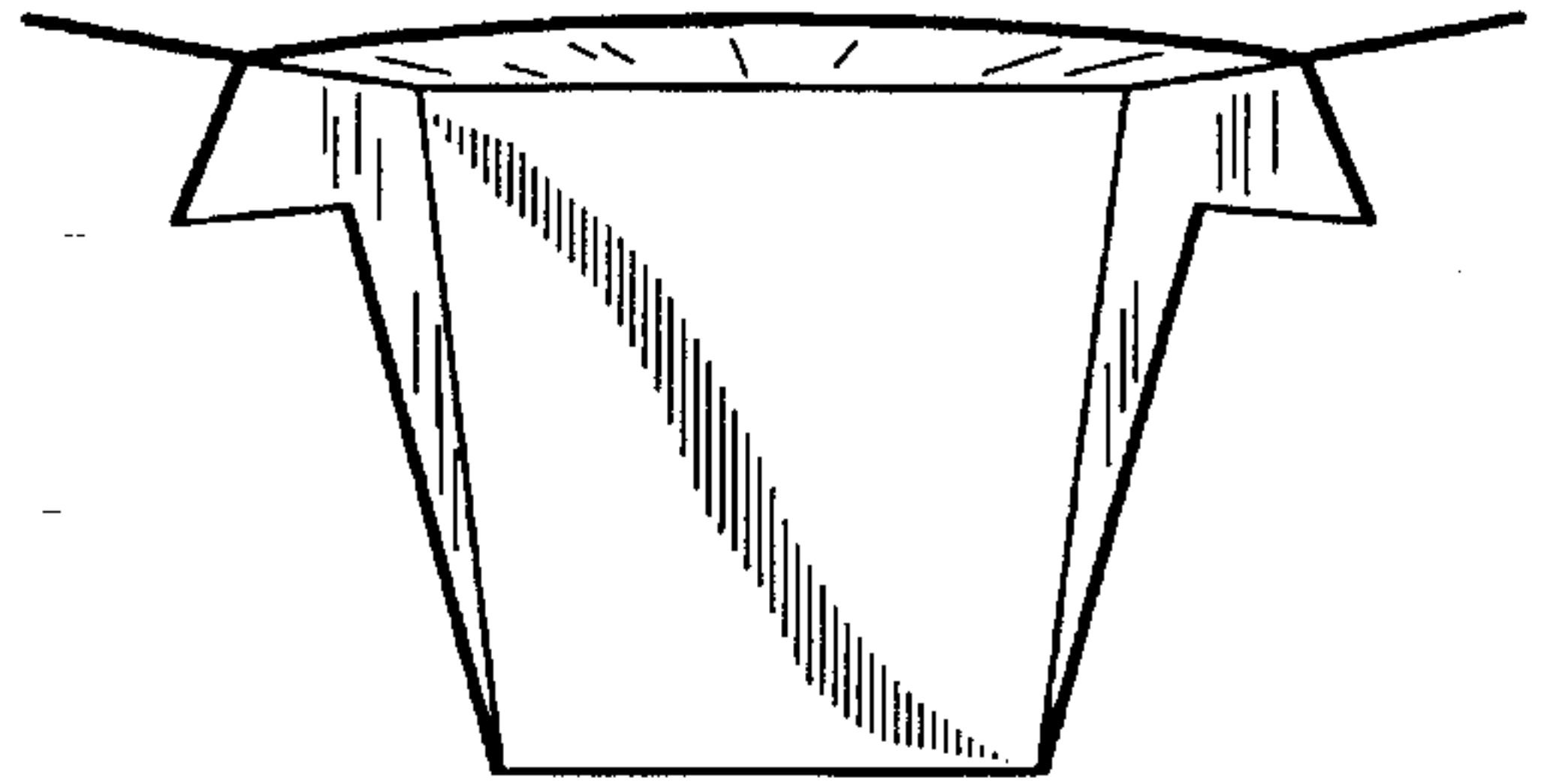

FIG. 2

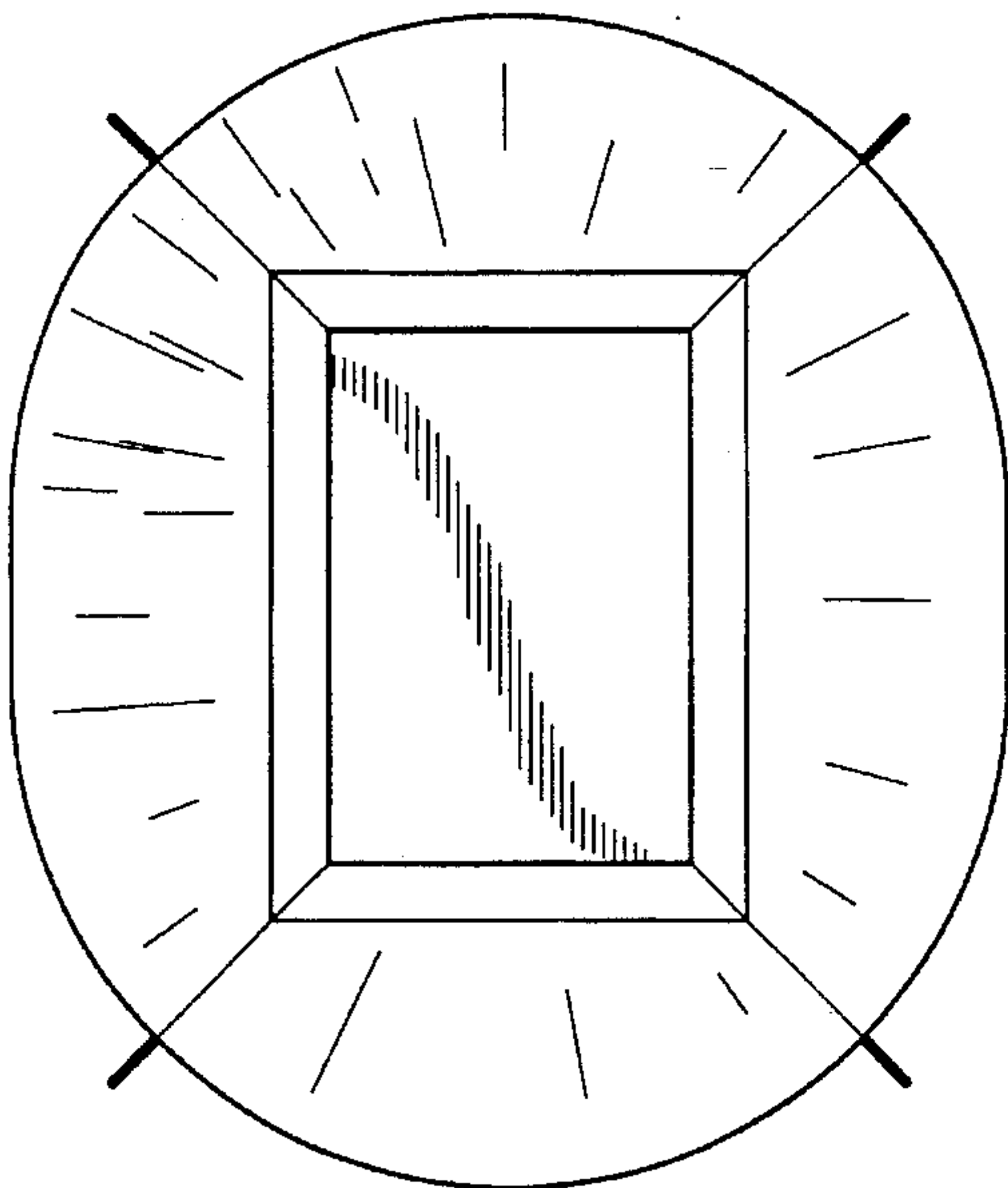

FIG. 3

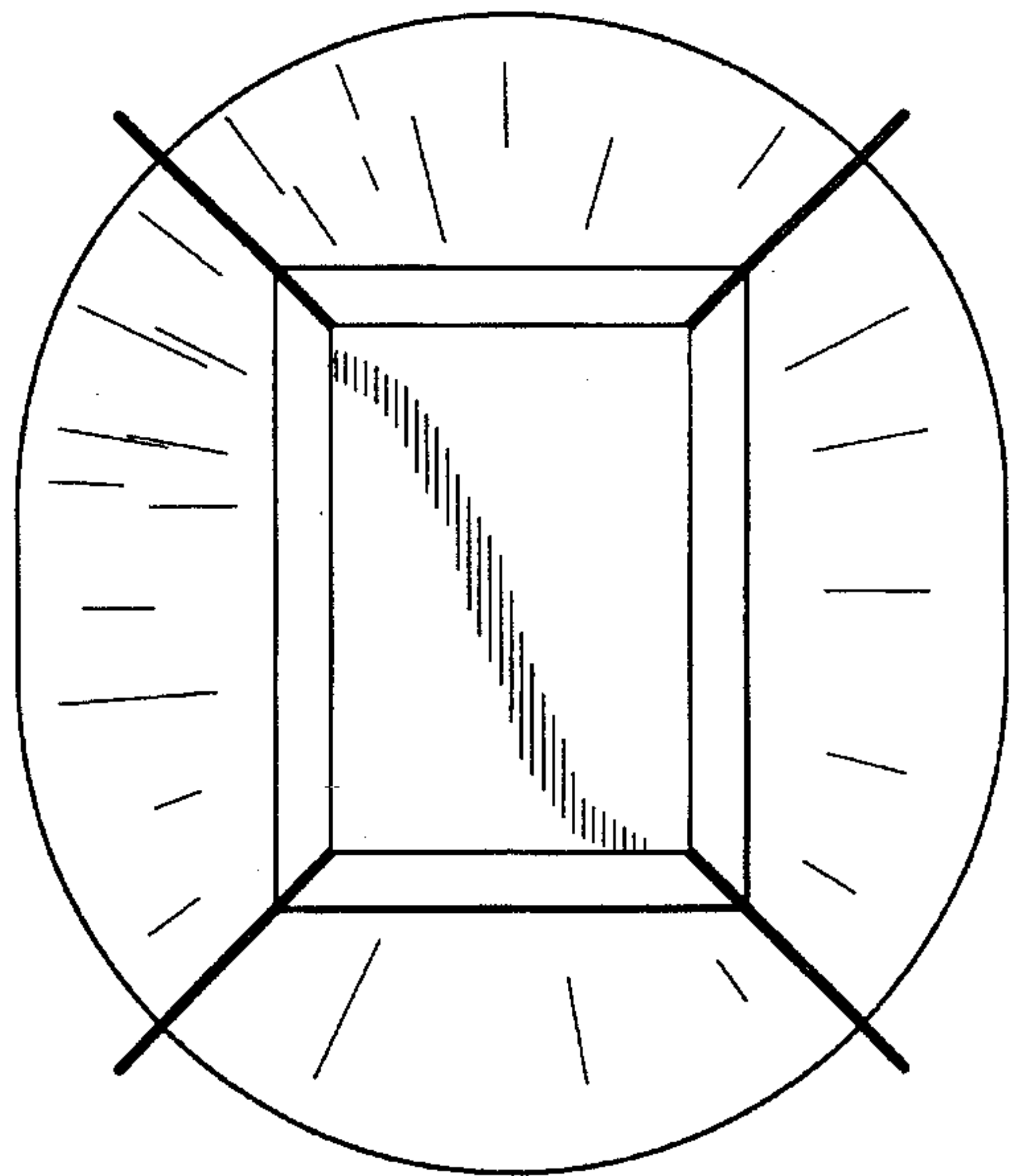

FIG. 4

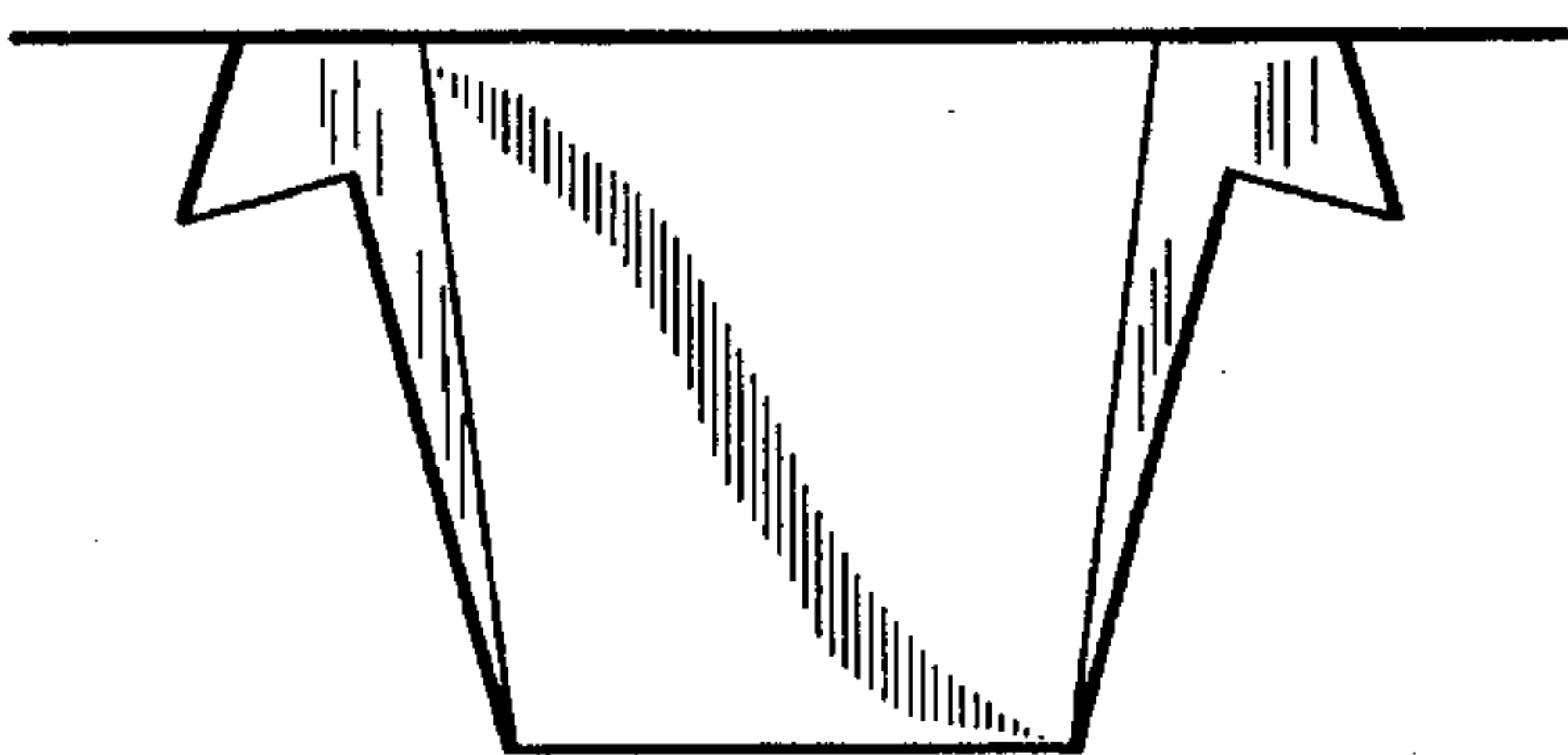

FIG. 5

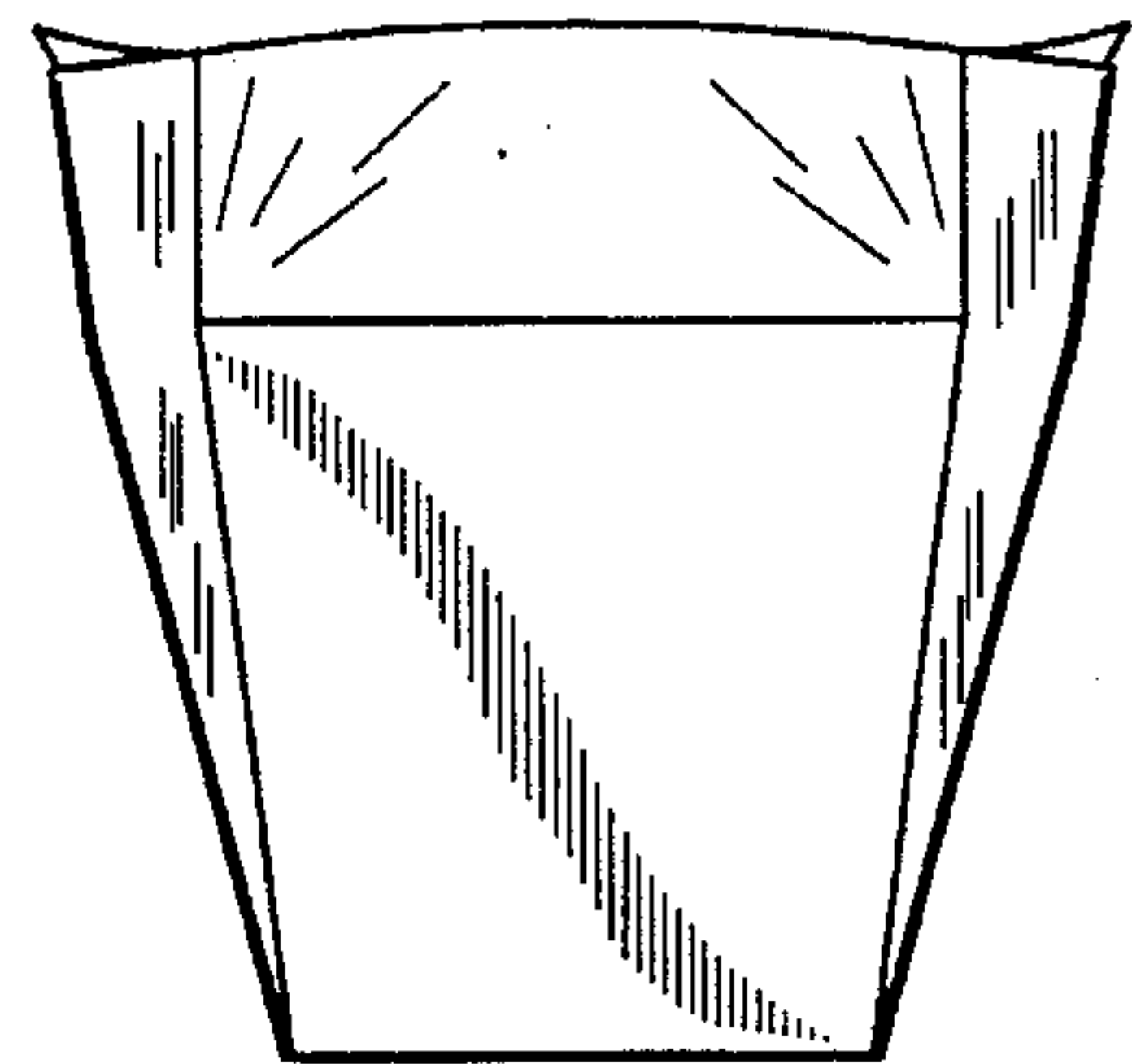

FIG. 6

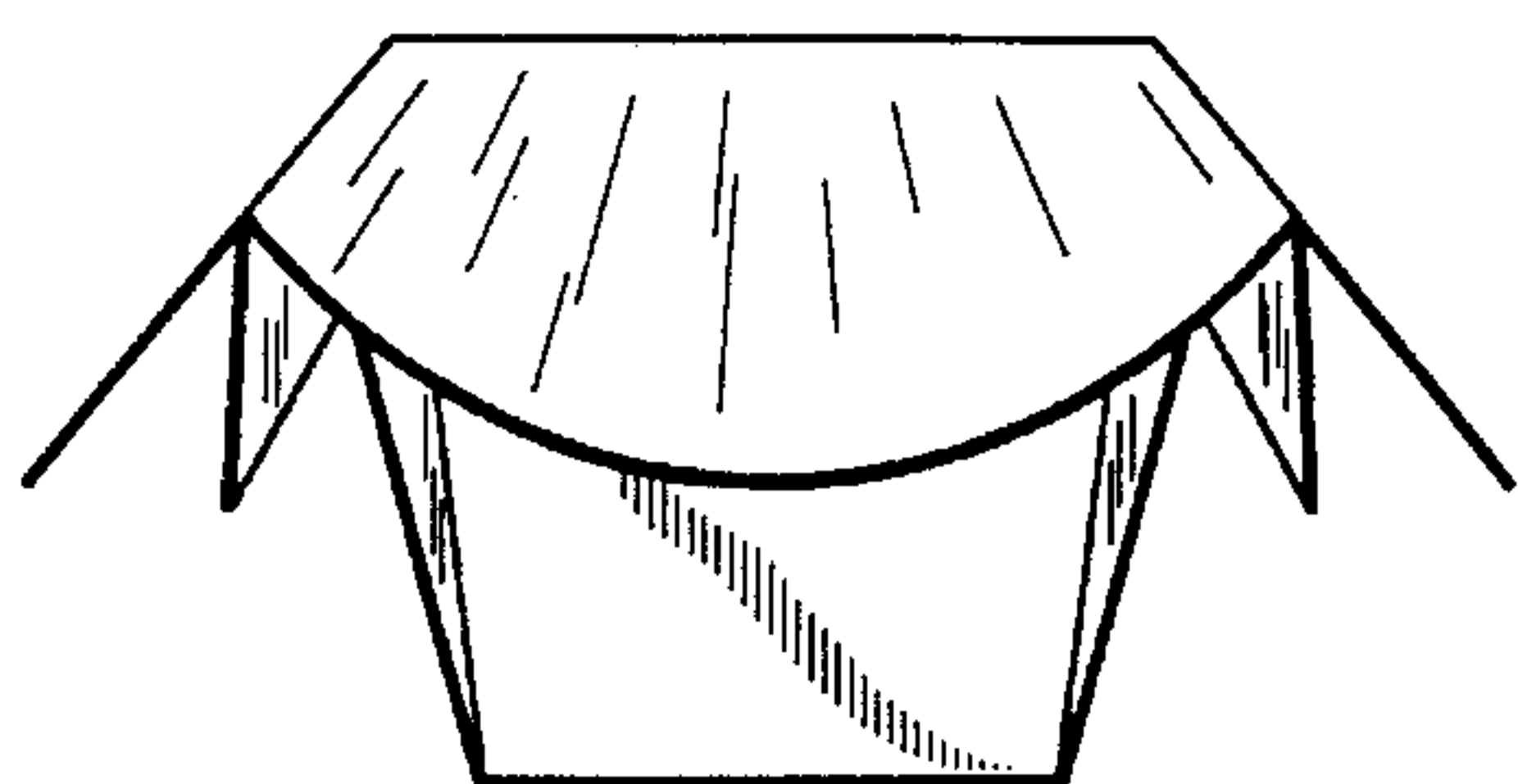

FIG. 7

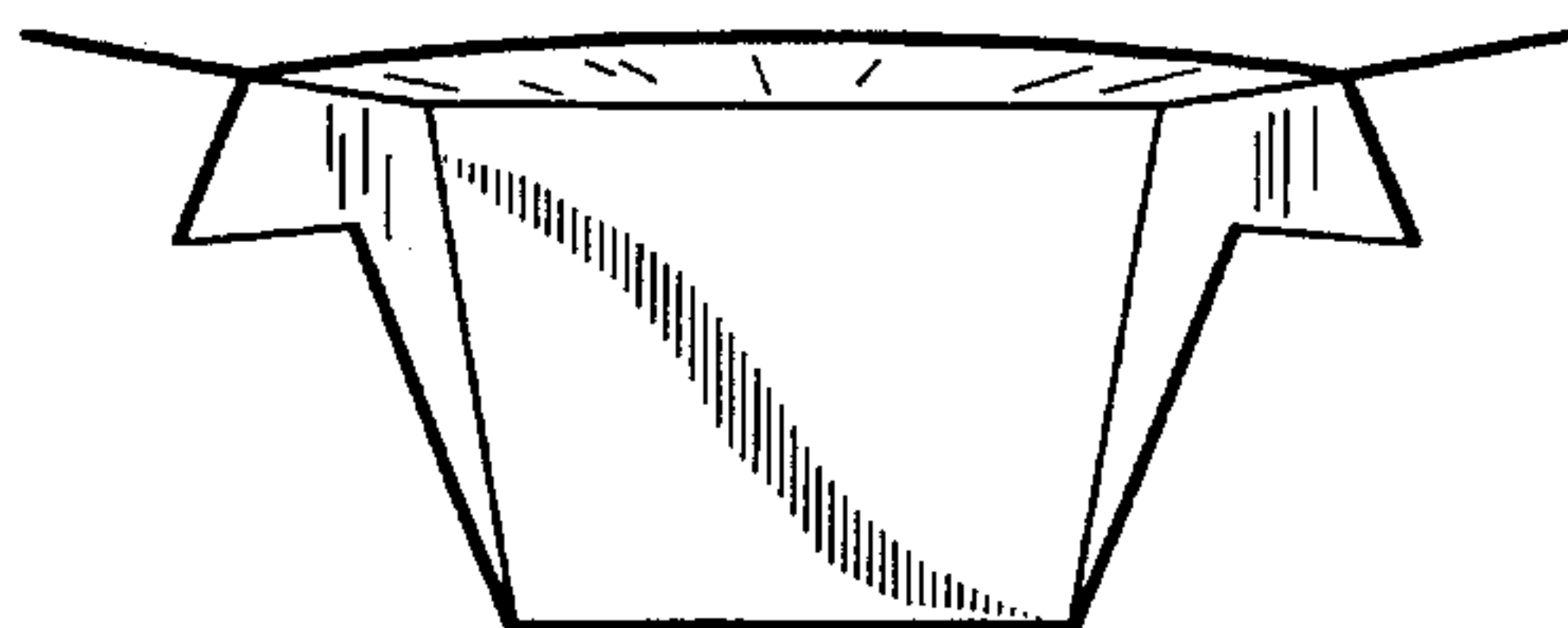

FIG. 8

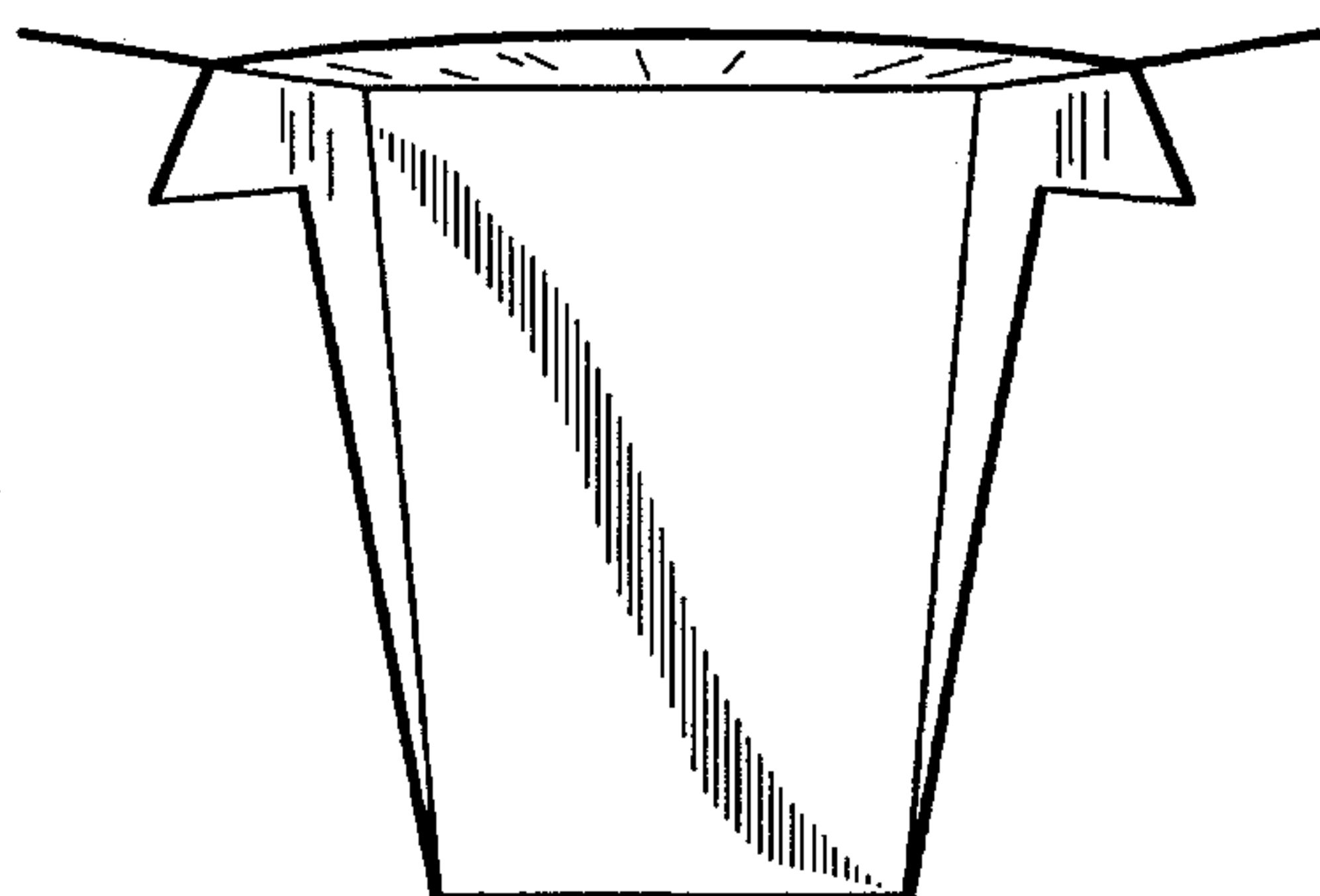

FIG. 9

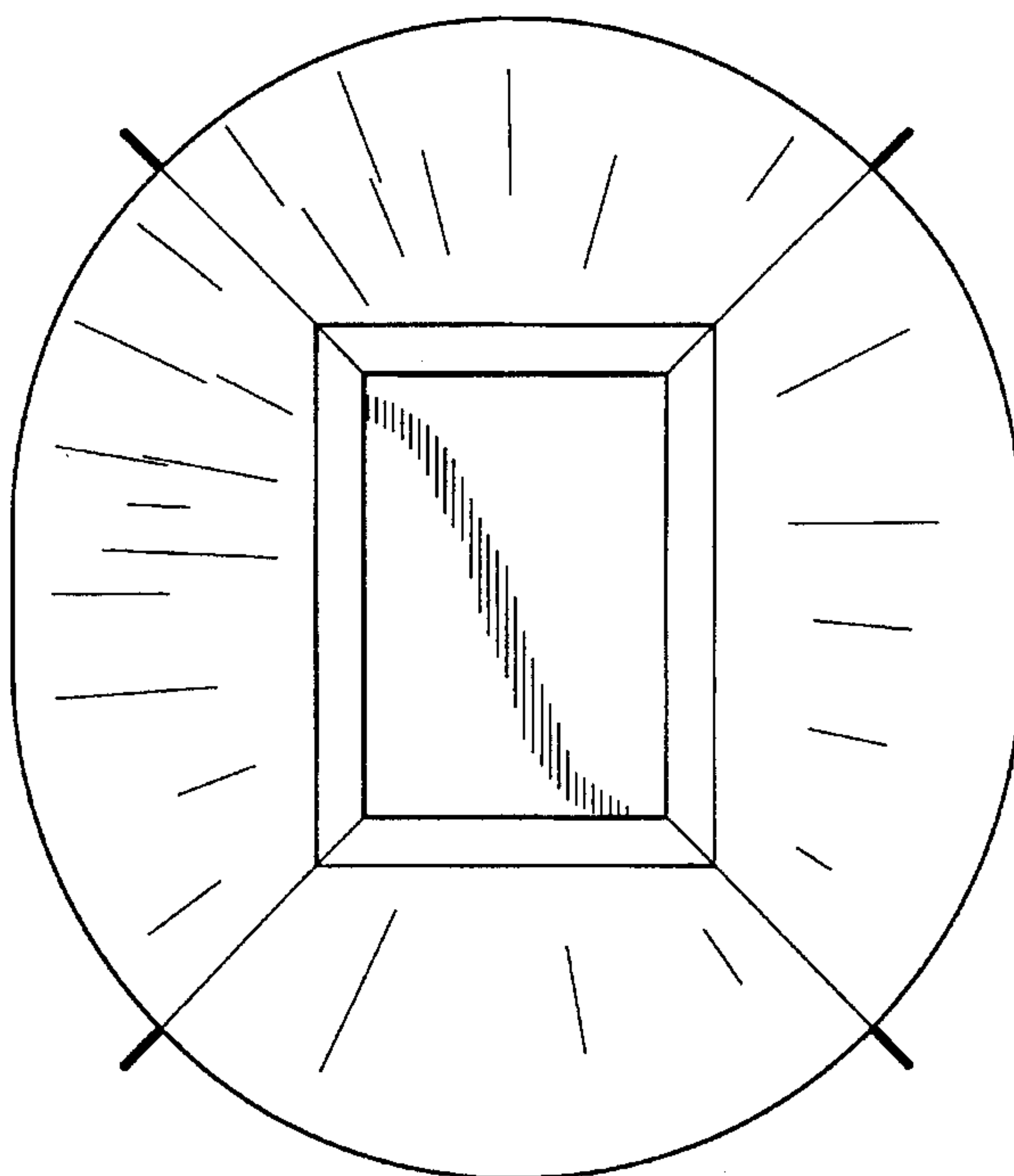

FIG. 10

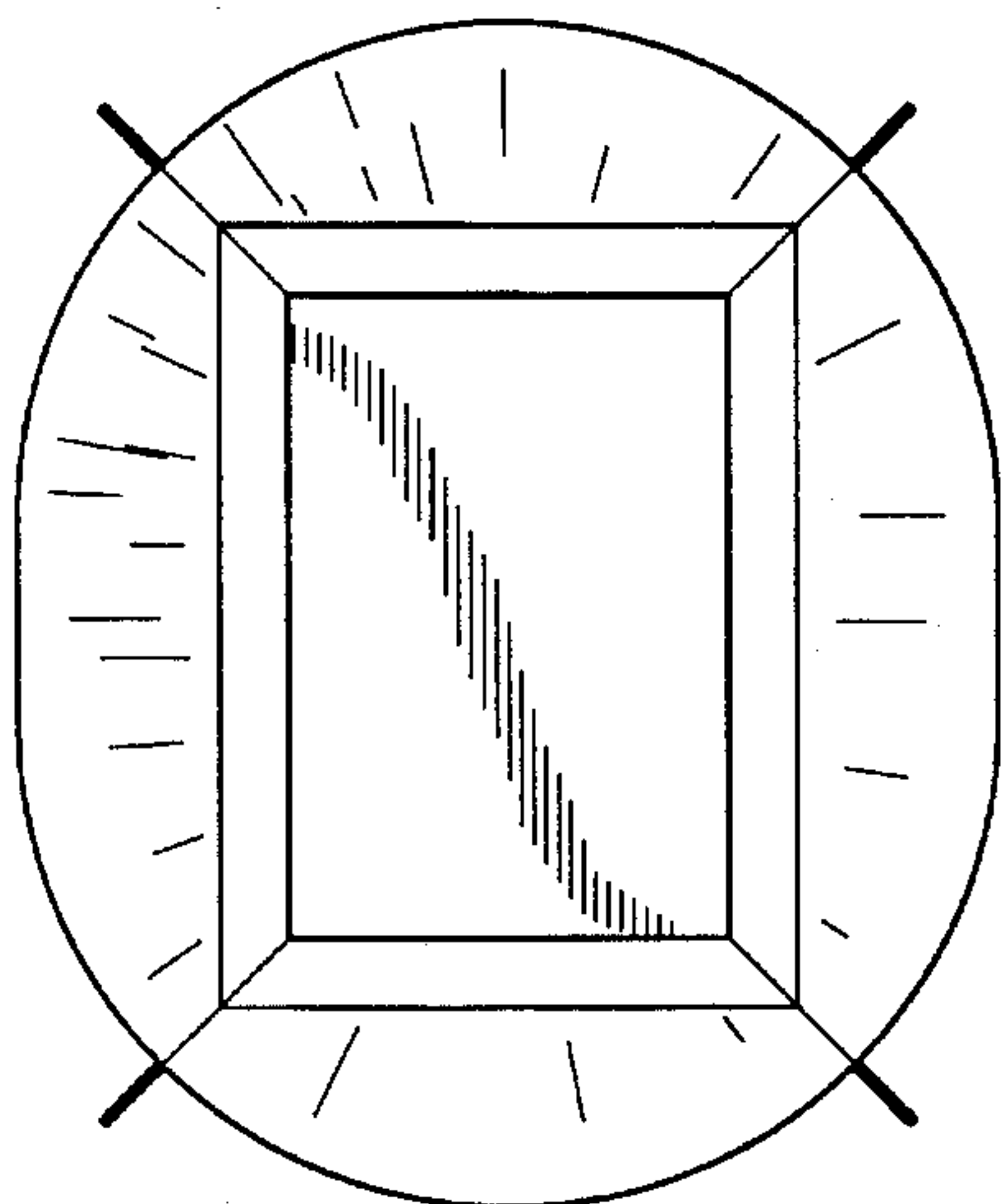

FIG. 11

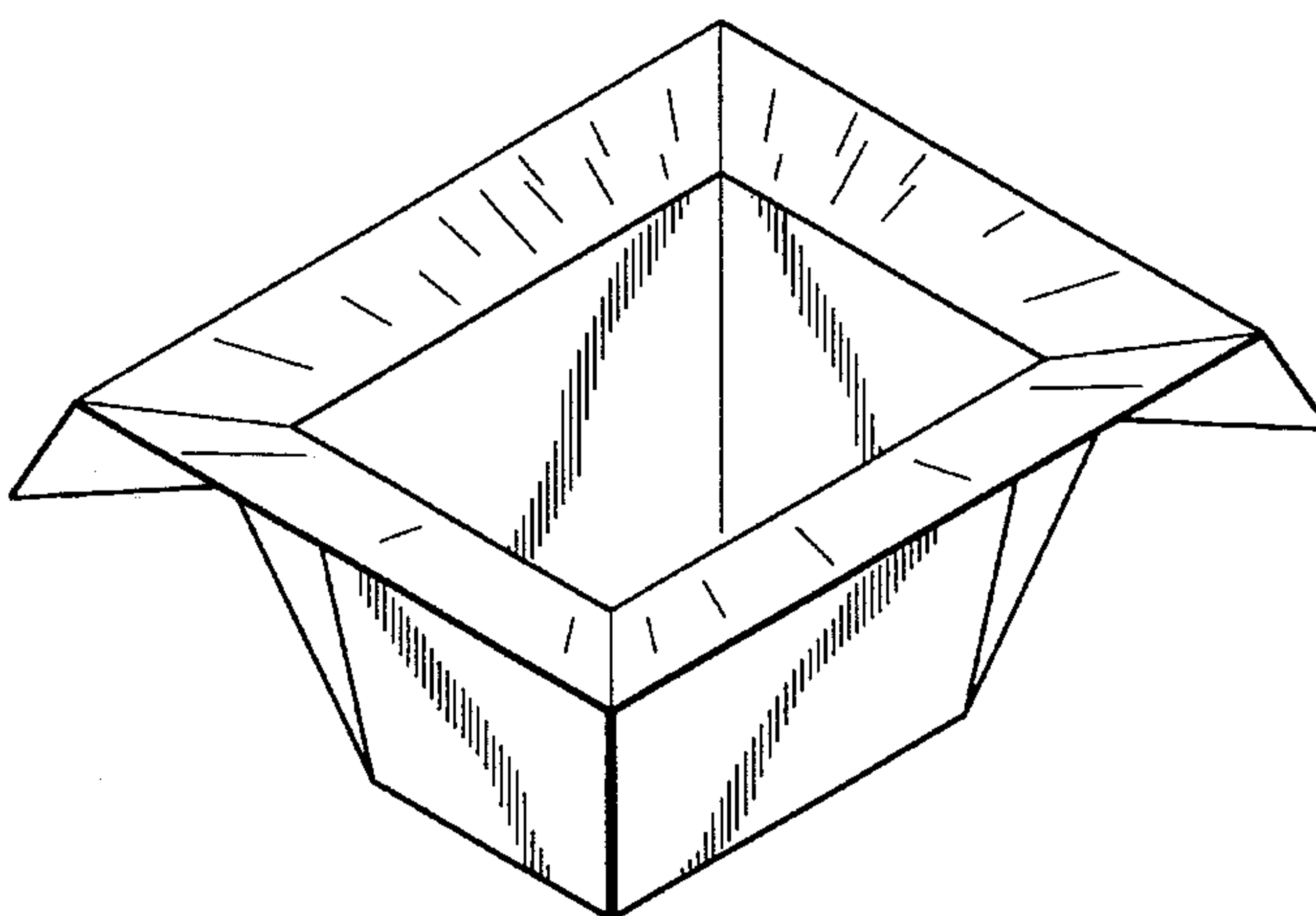

FIG. 12

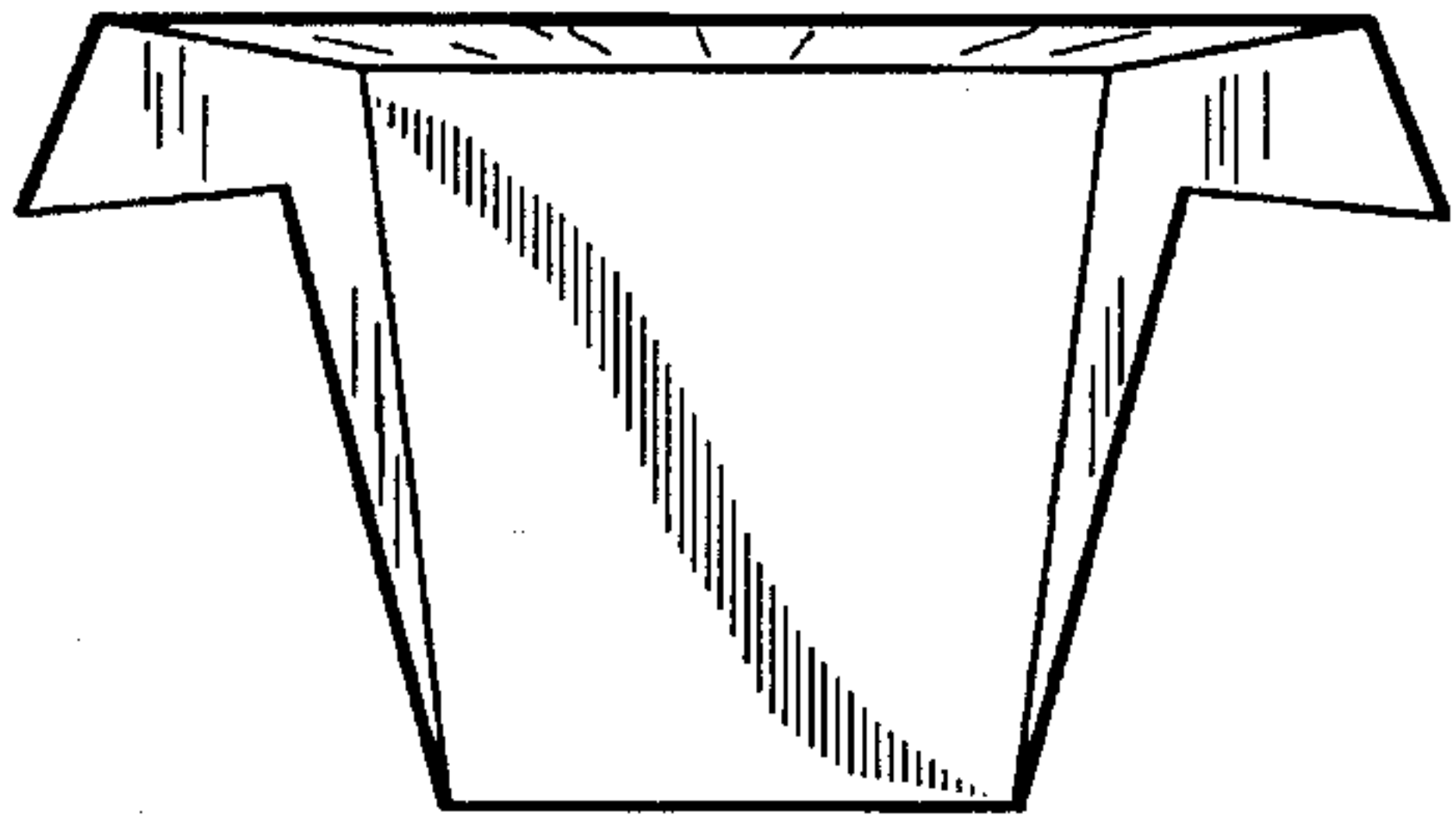

FIG. 13

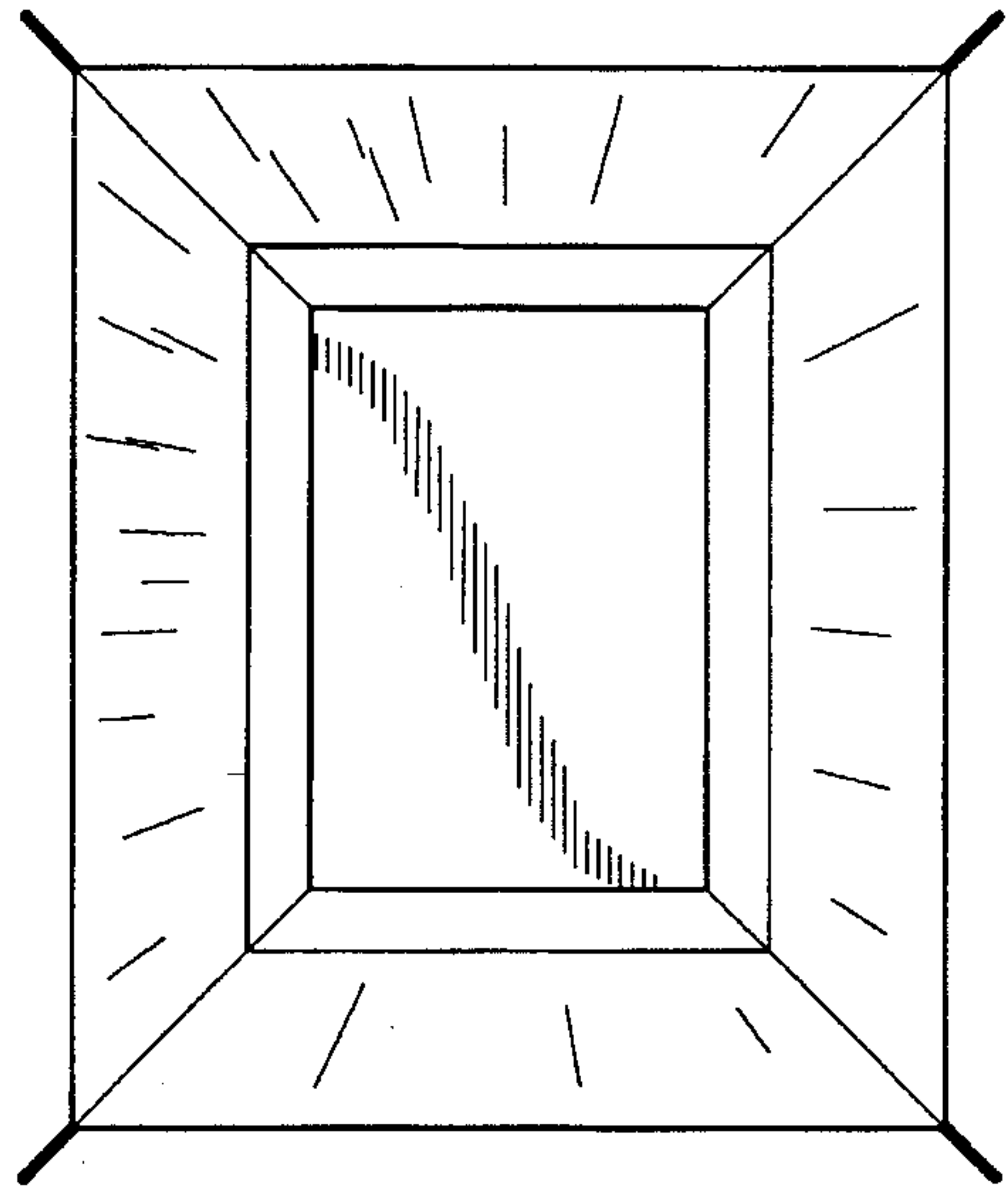

FIG. 14

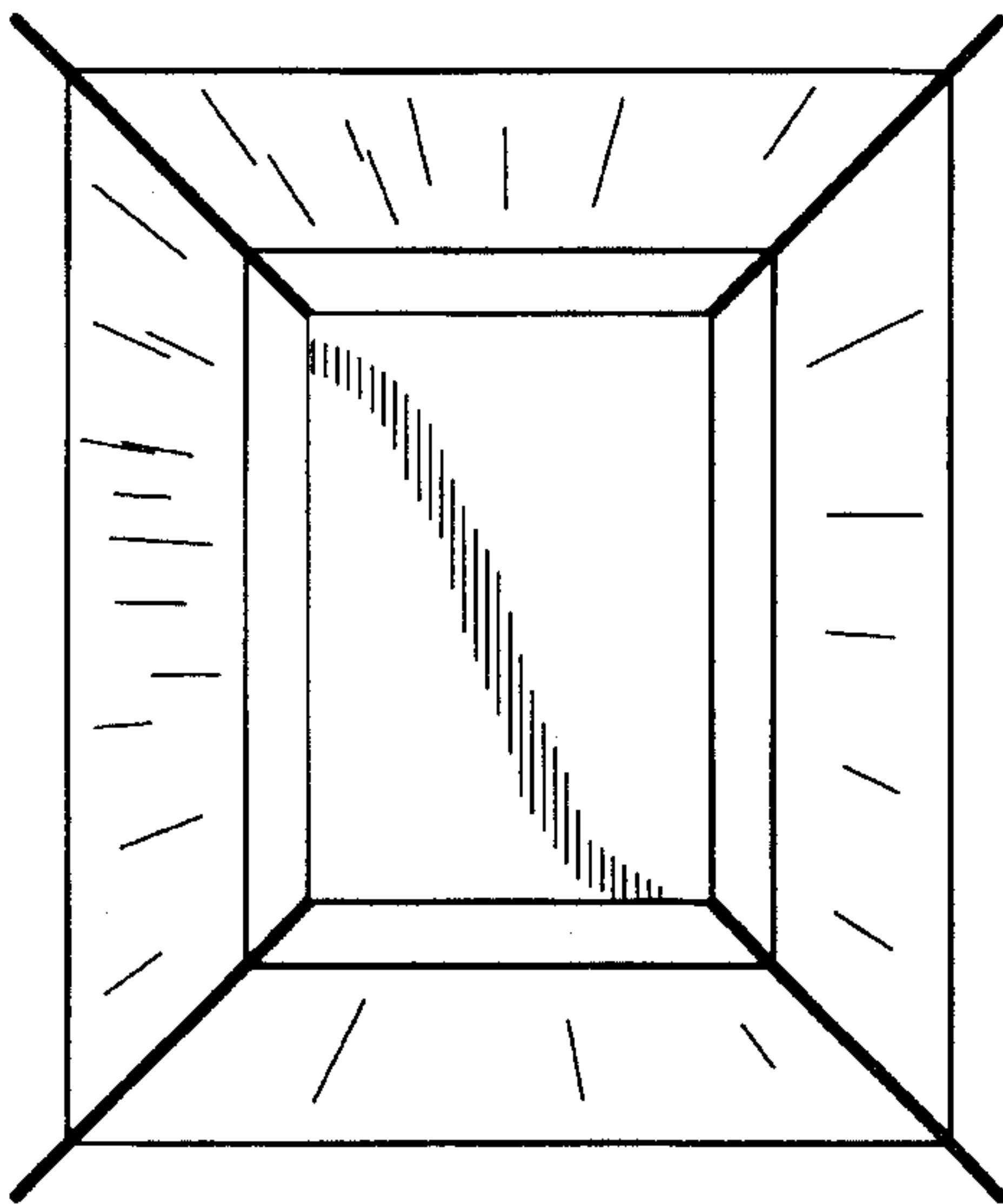

FIG. 15

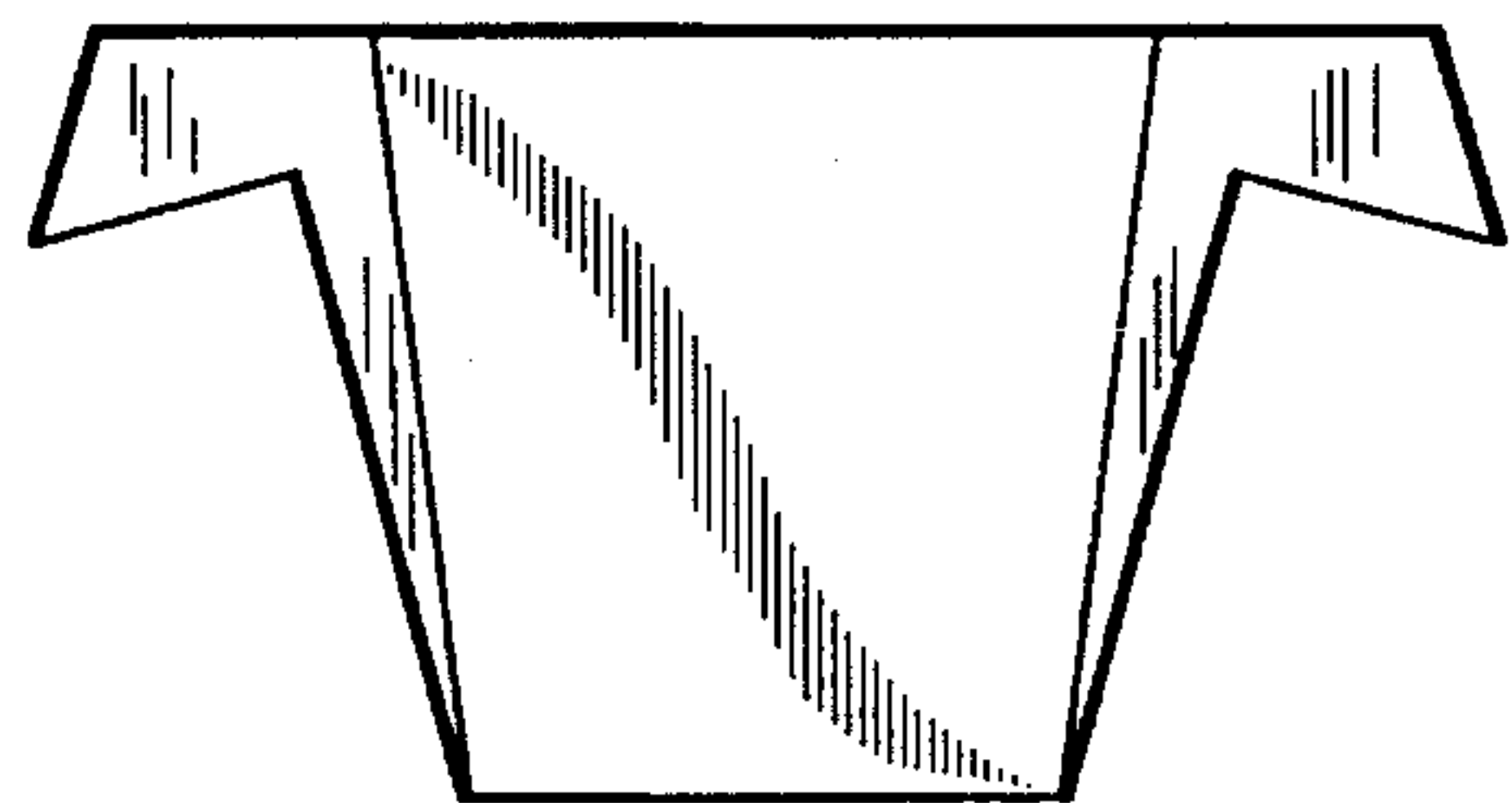

FIG. 16

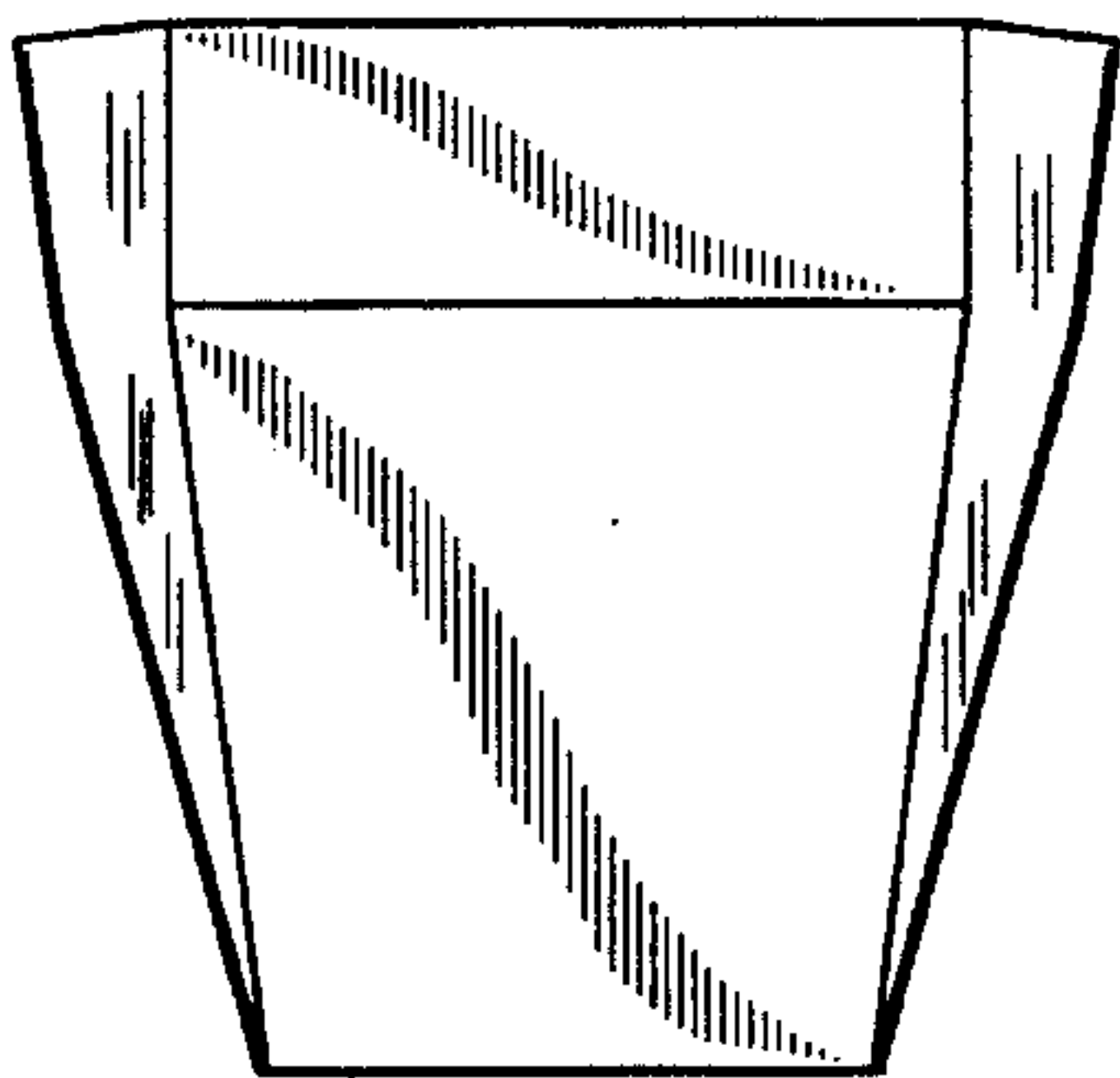

FIG. 17

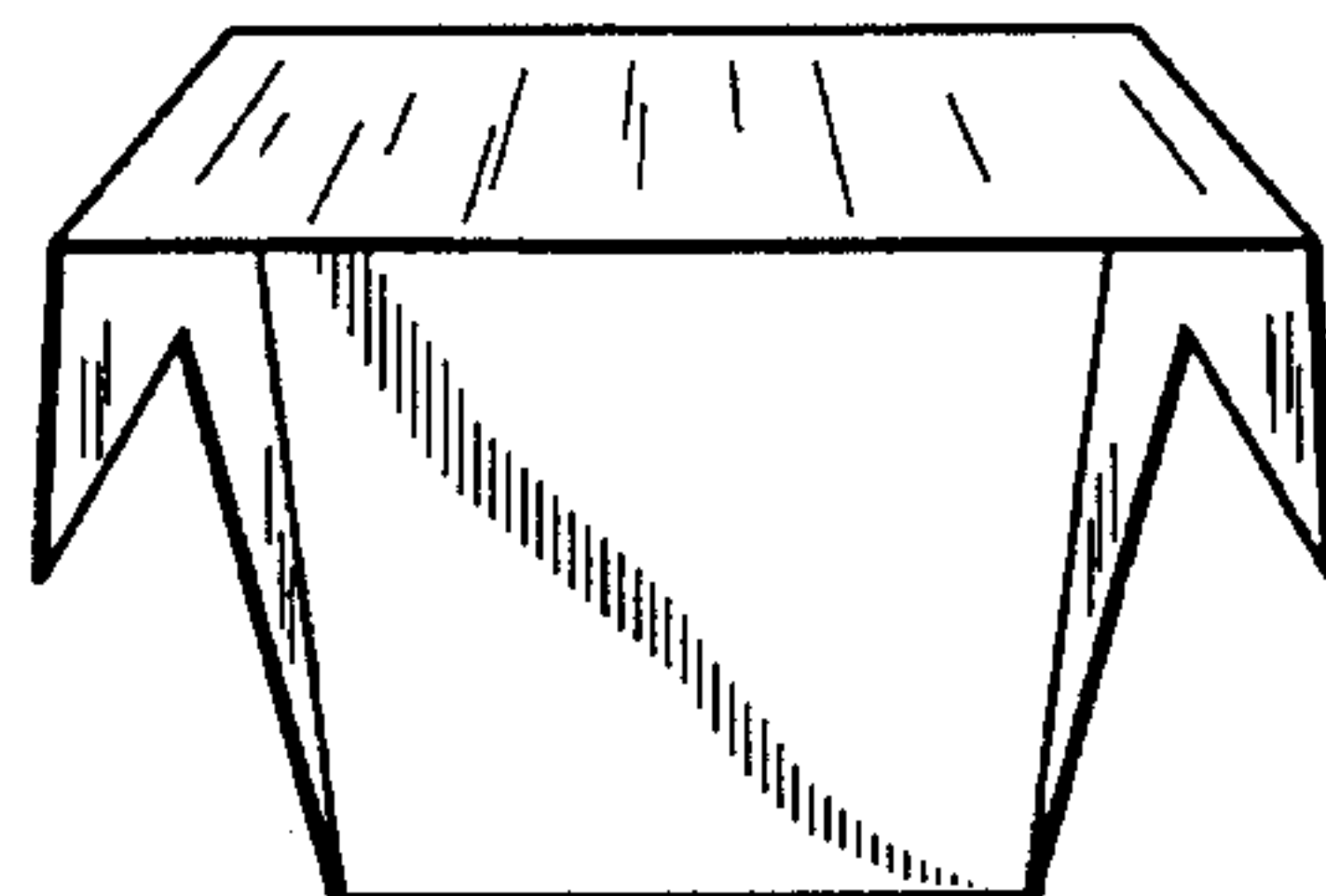

FIG. 18

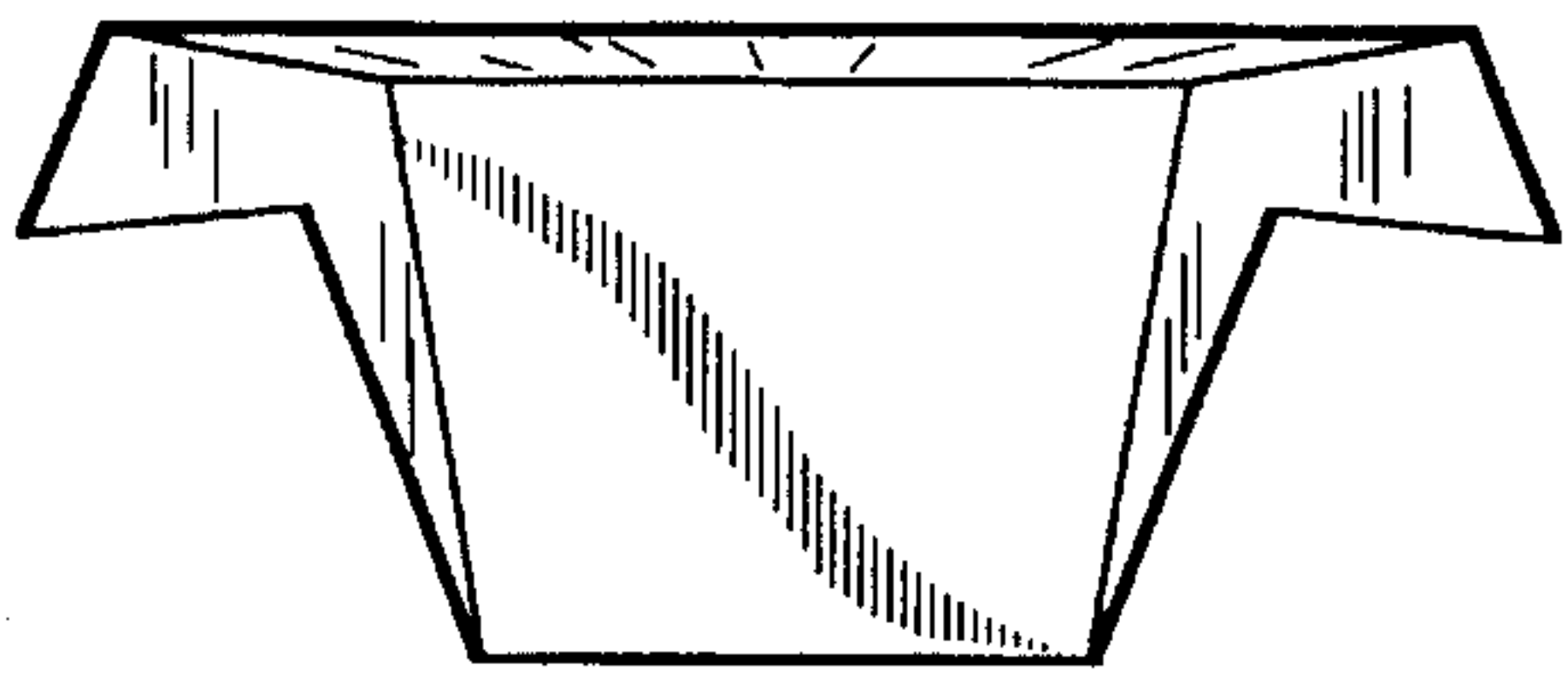

FIG. 19

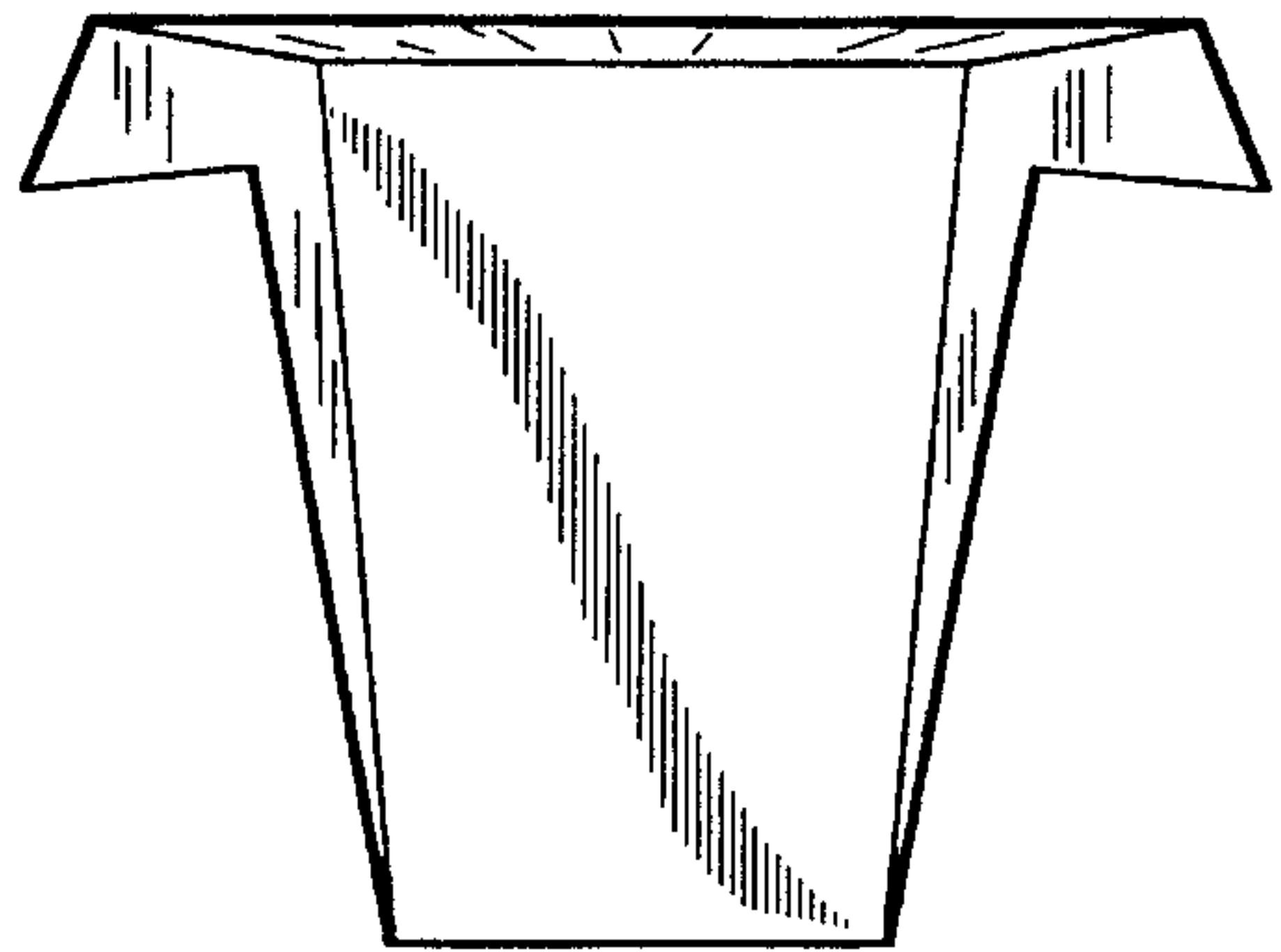

FIG. 20

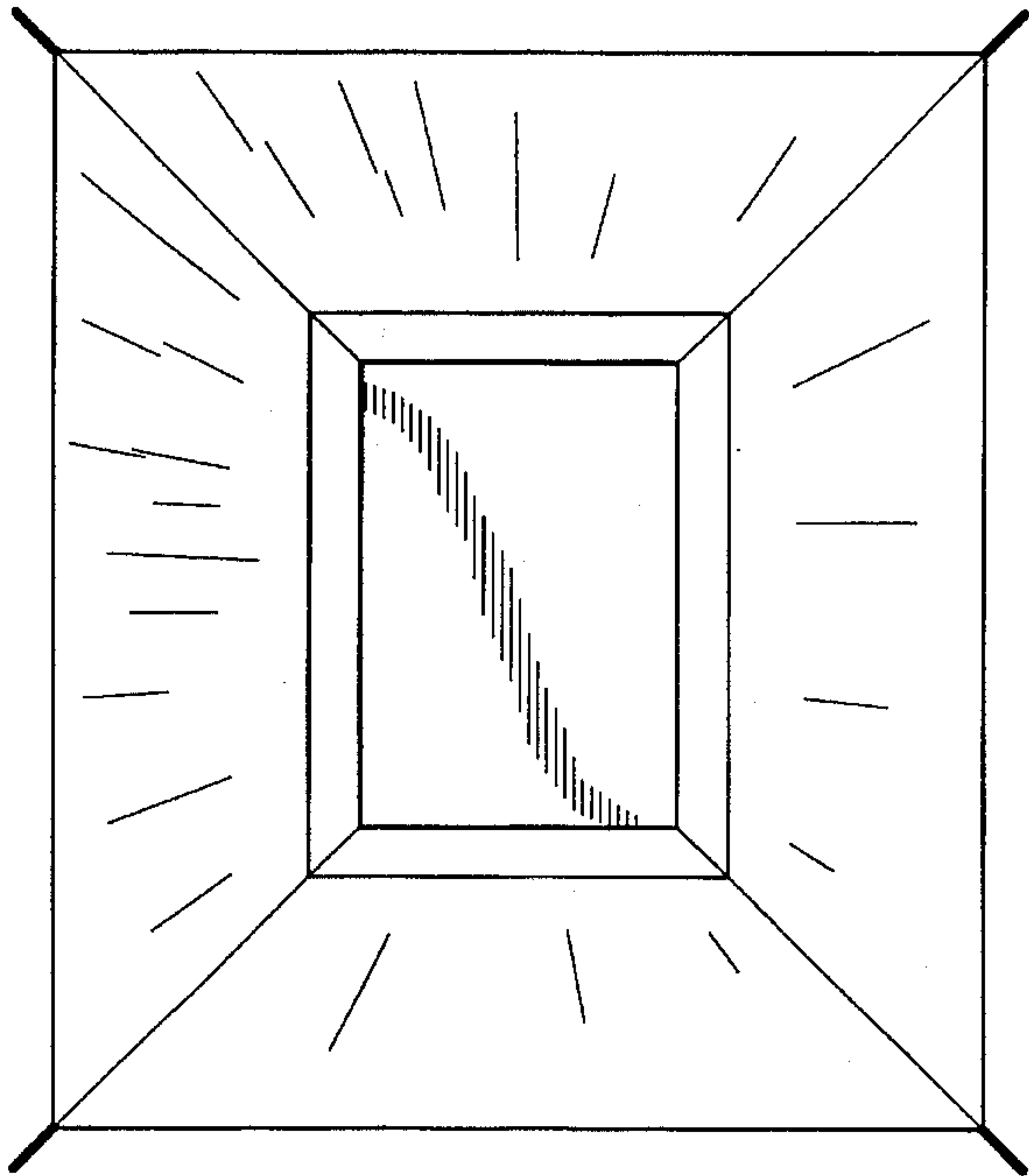

FIG. 21

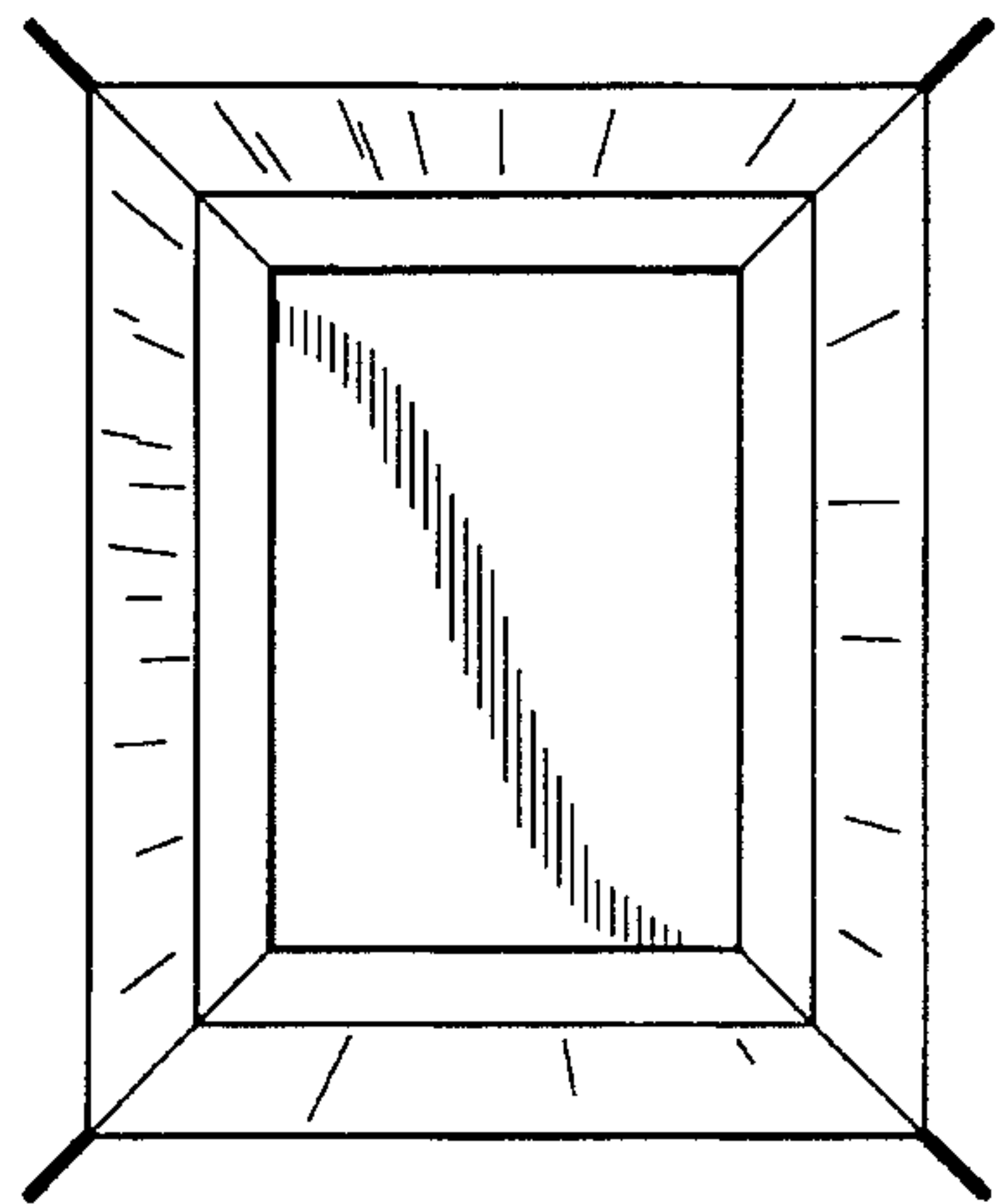

FIG. 22

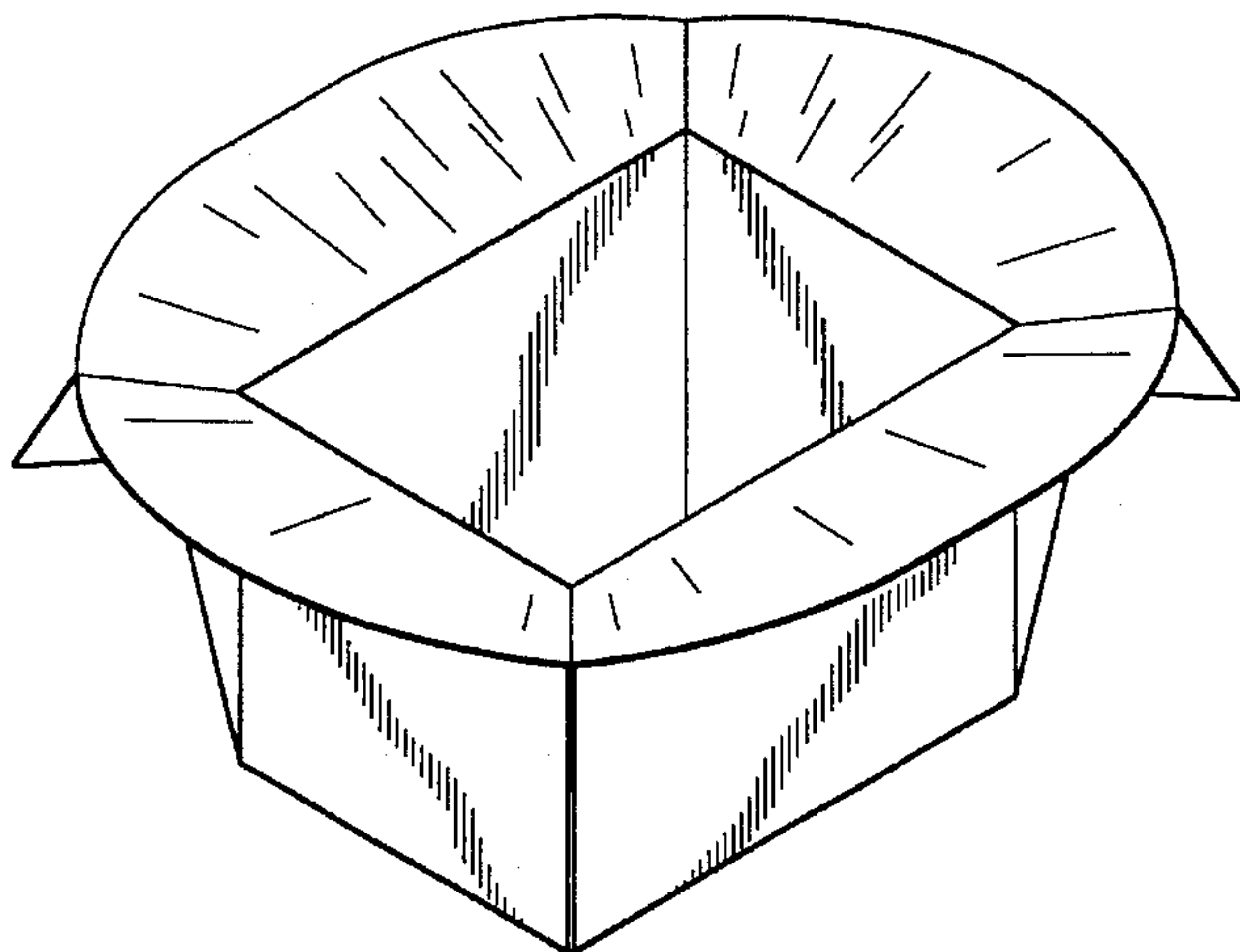

FIG. 23

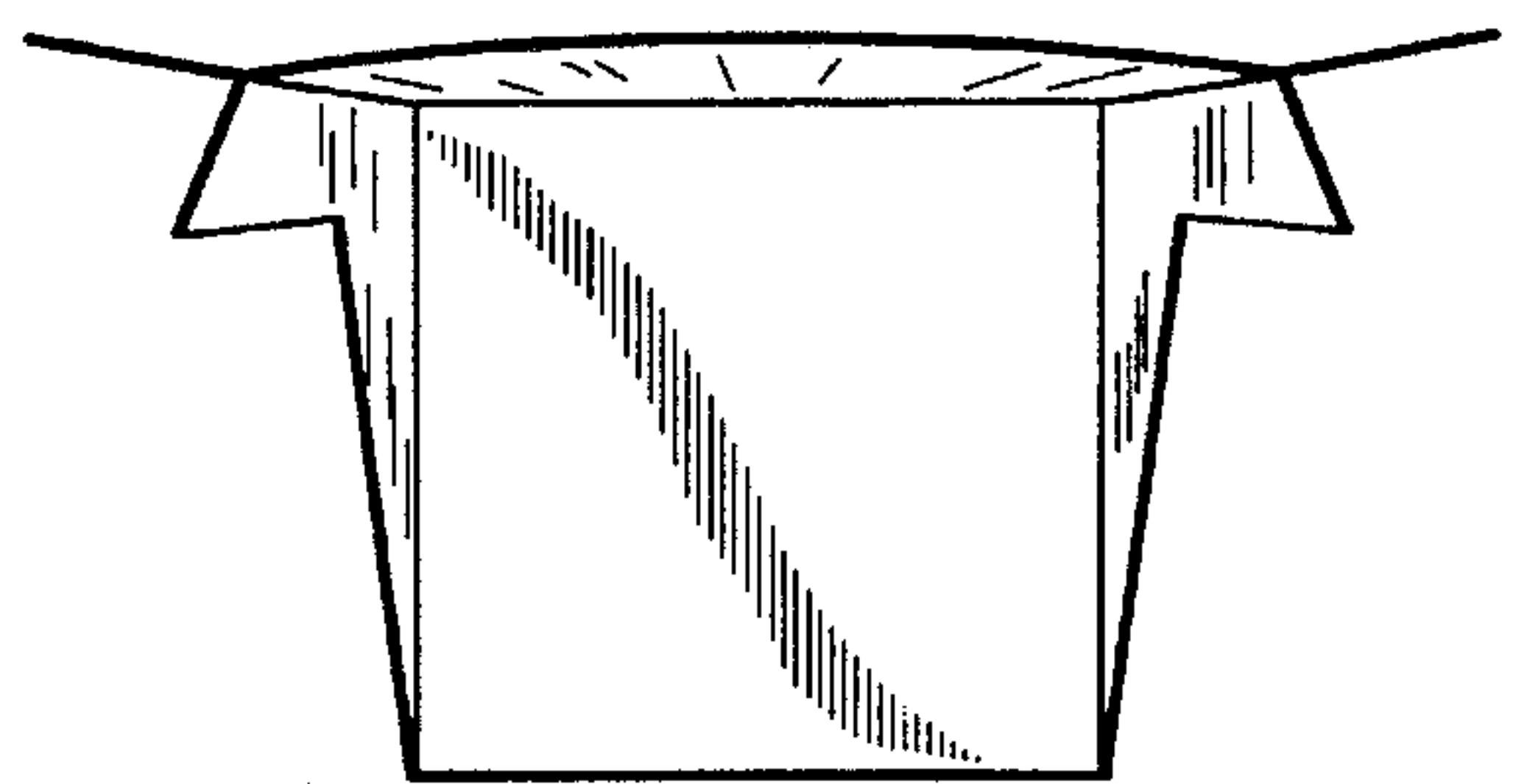

FIG. 24

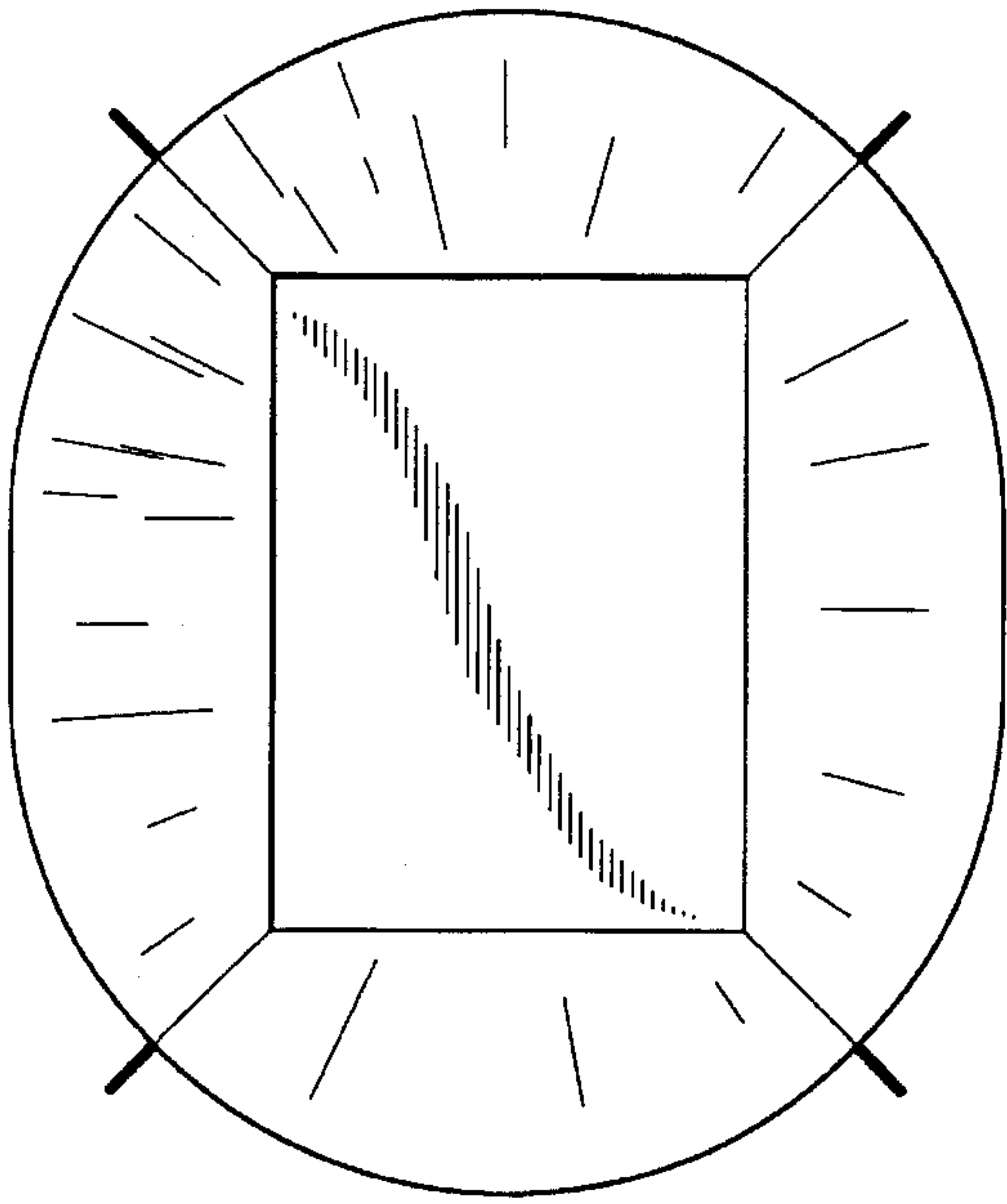

FIG. 25

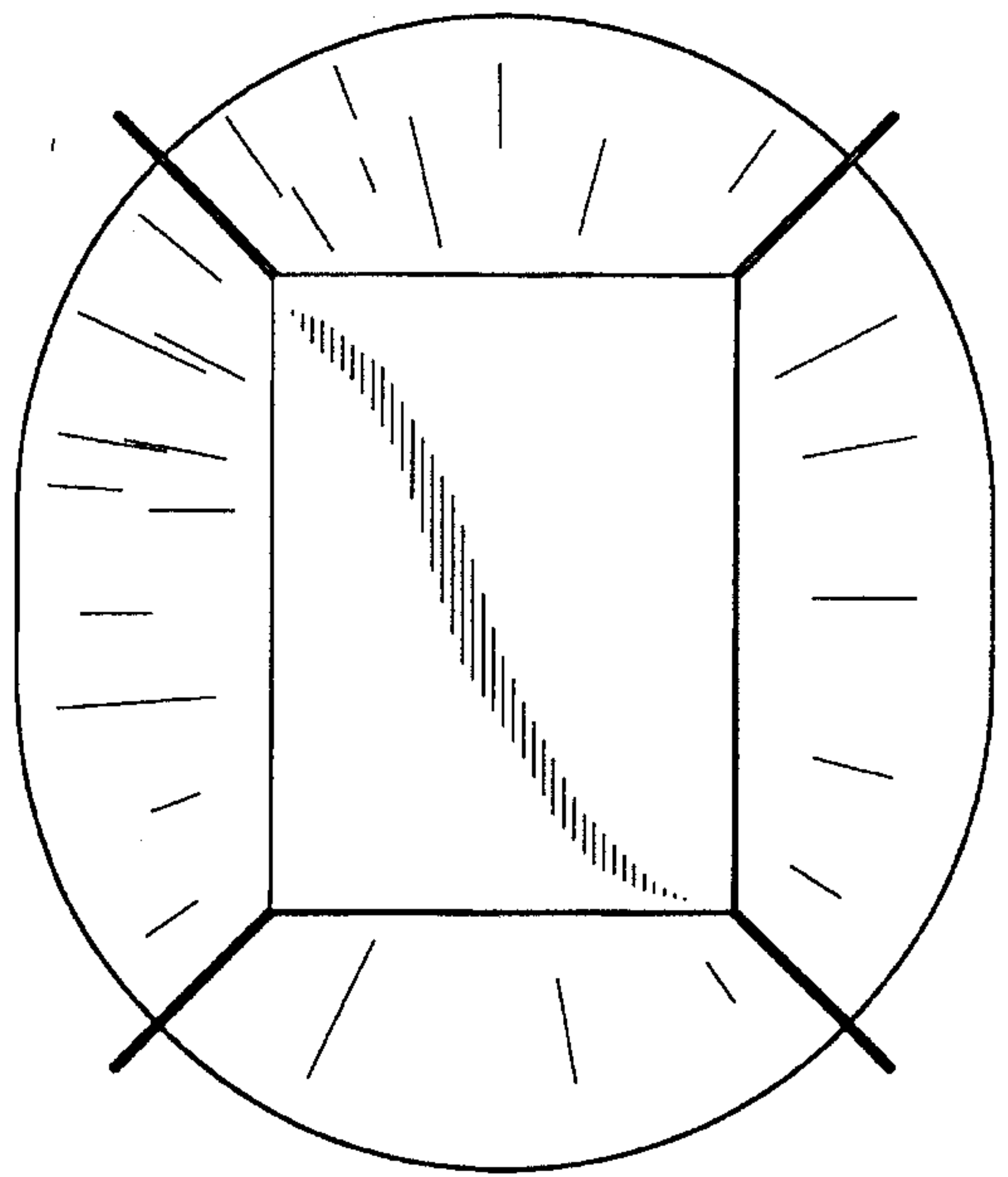

FIG. 26

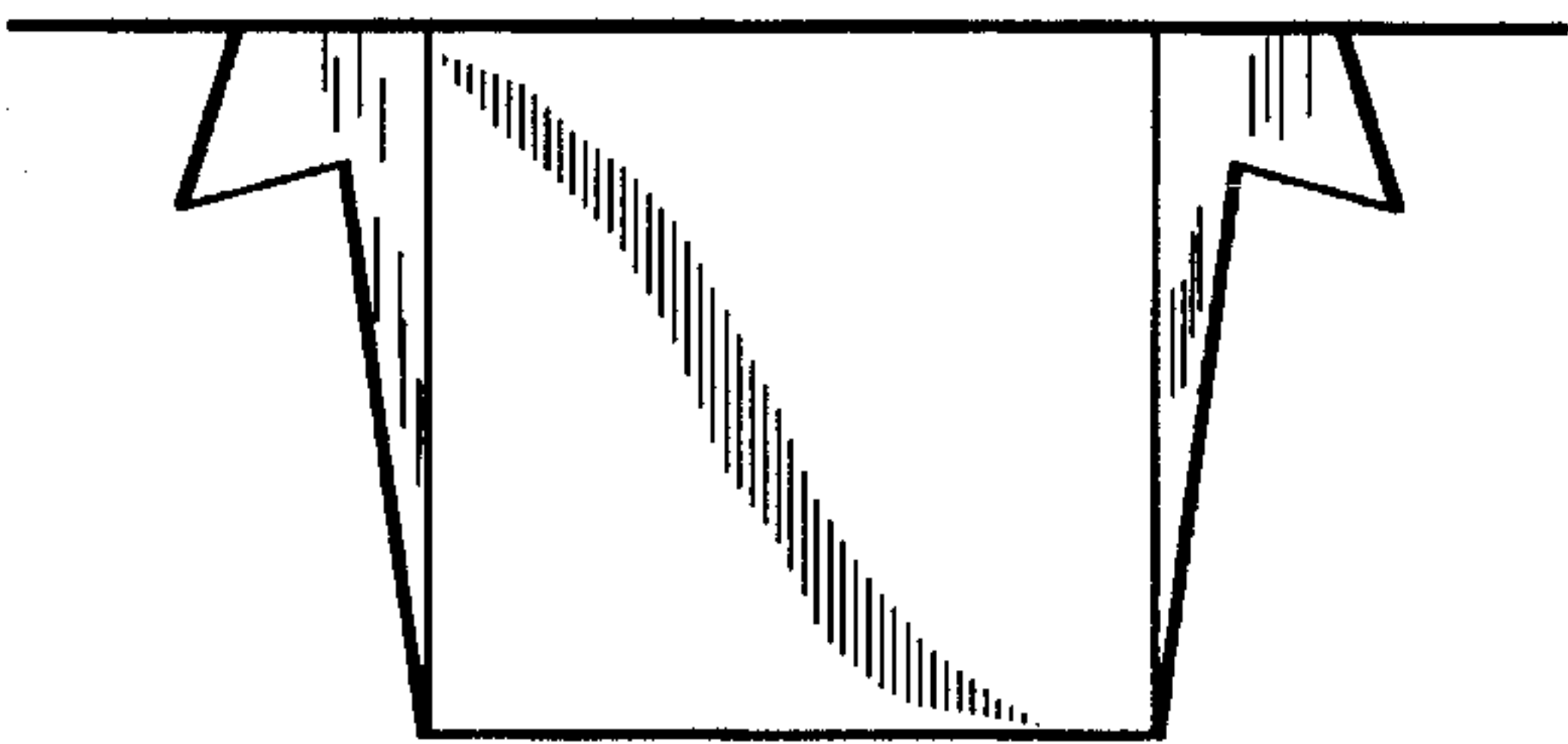

FIG. 27

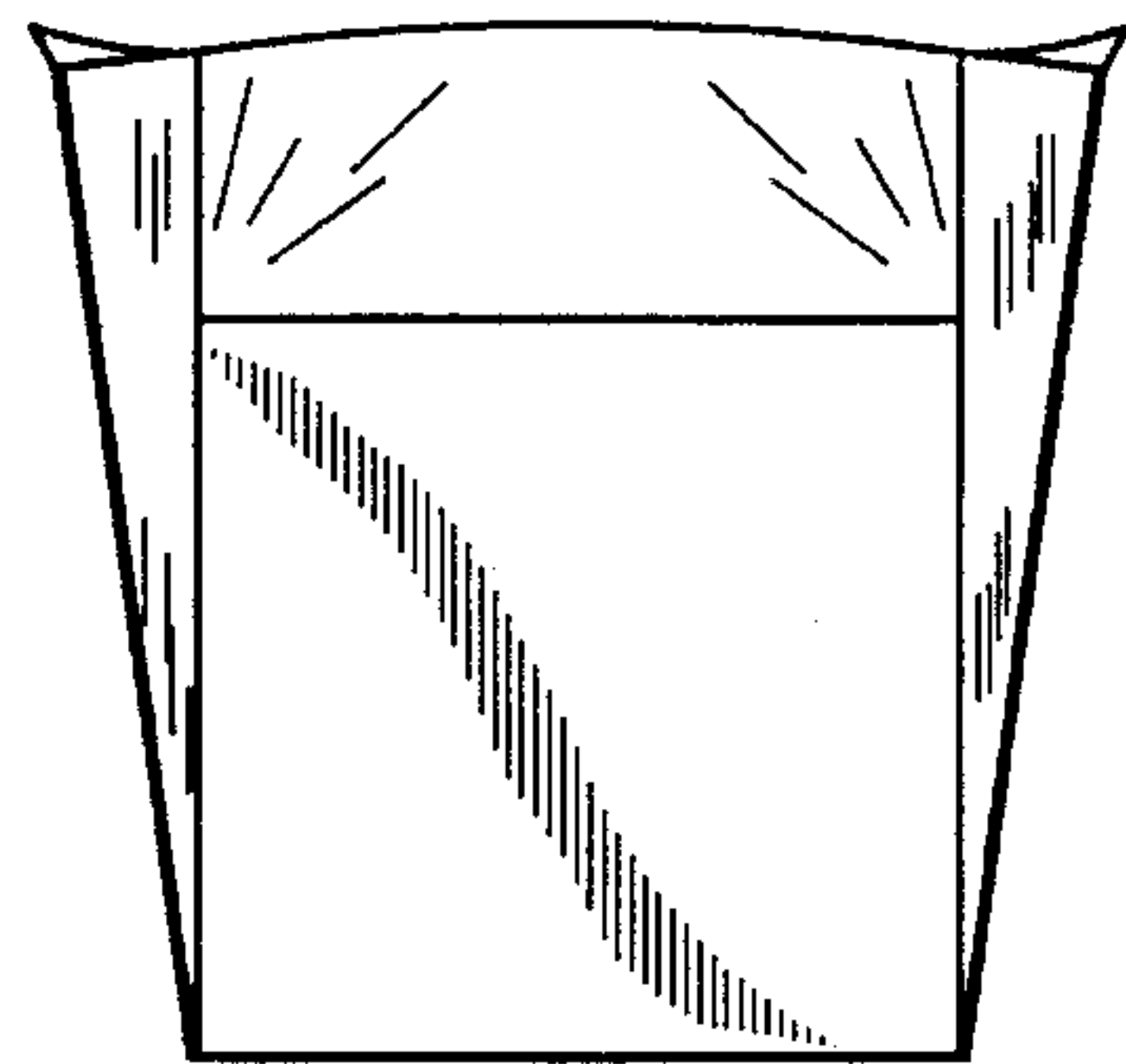

FIG. 28

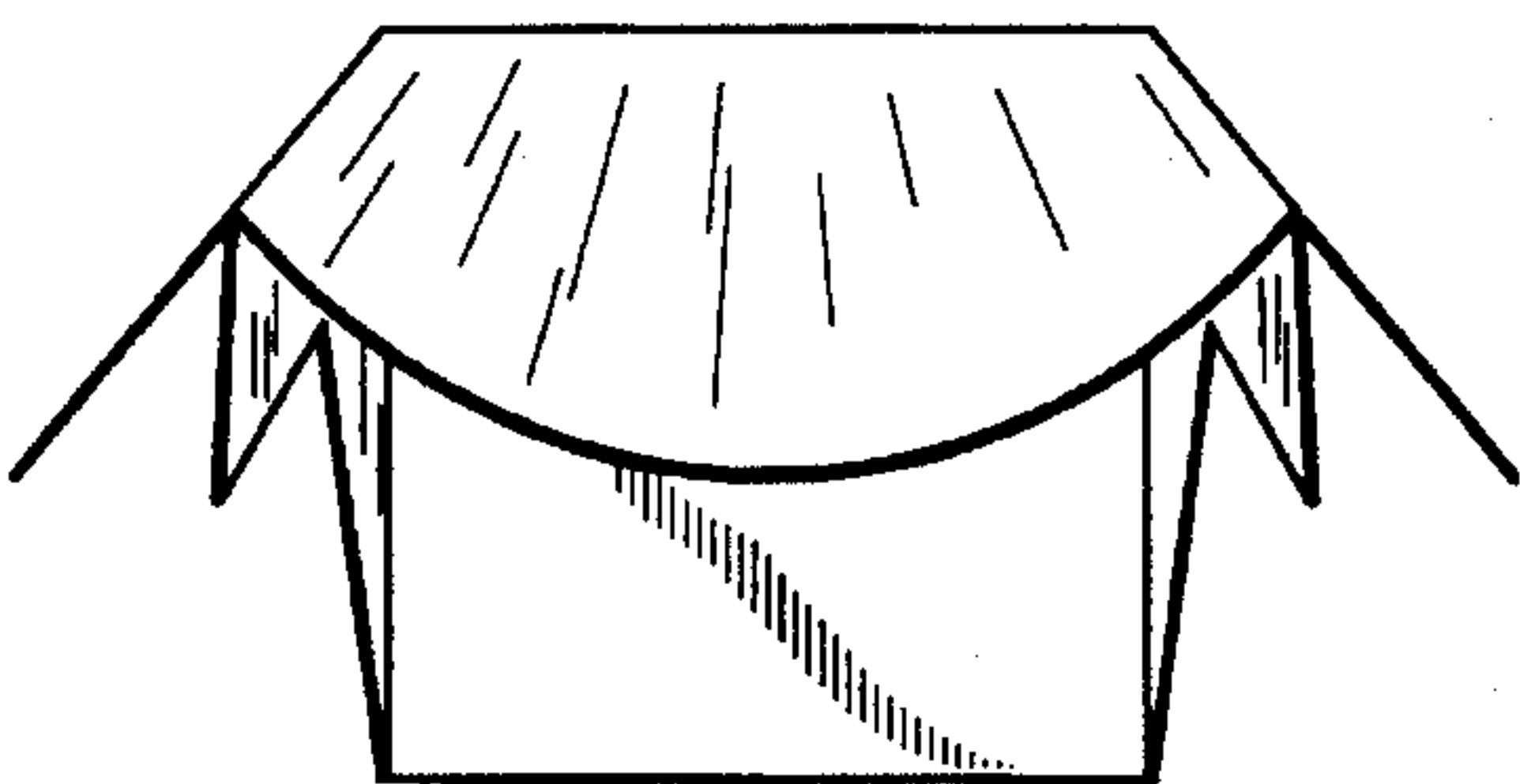

FIG. 29

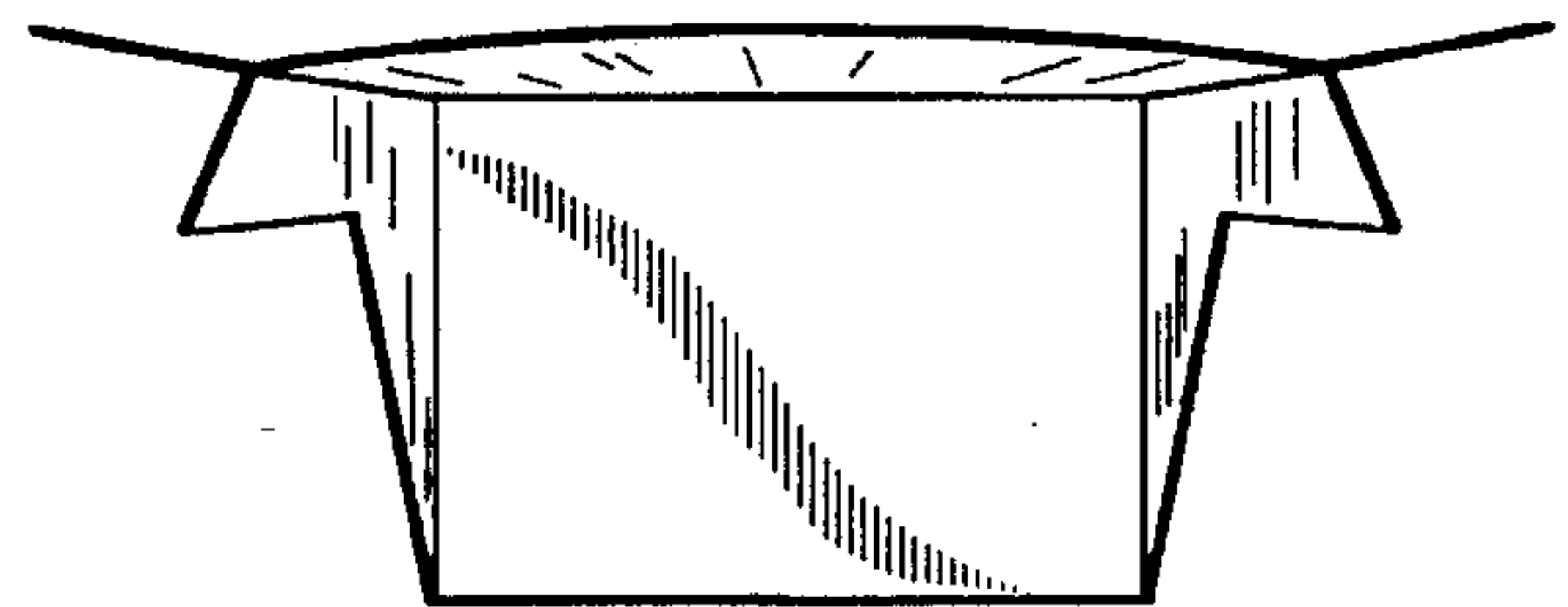

FIG. 30

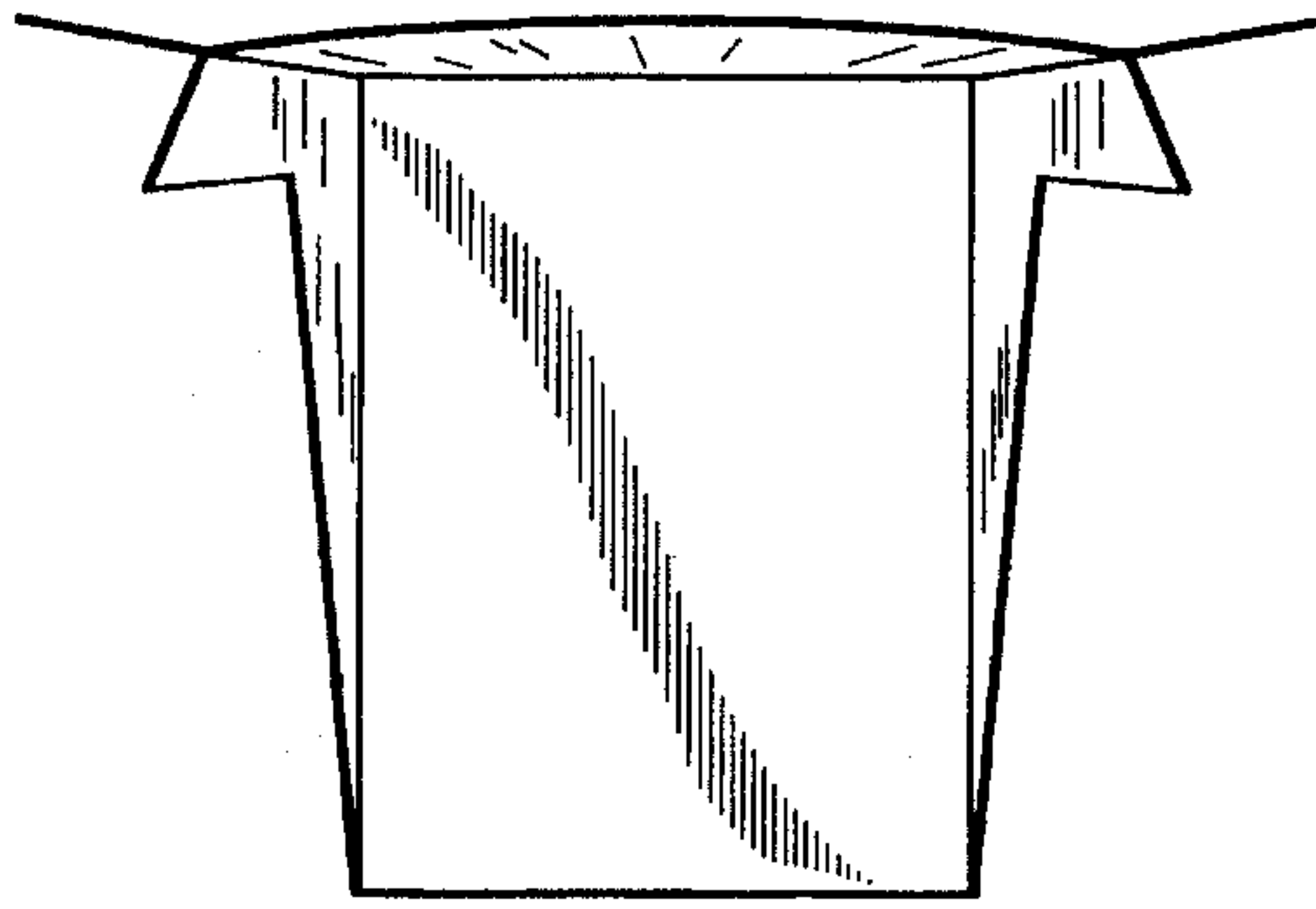

FIG. 31

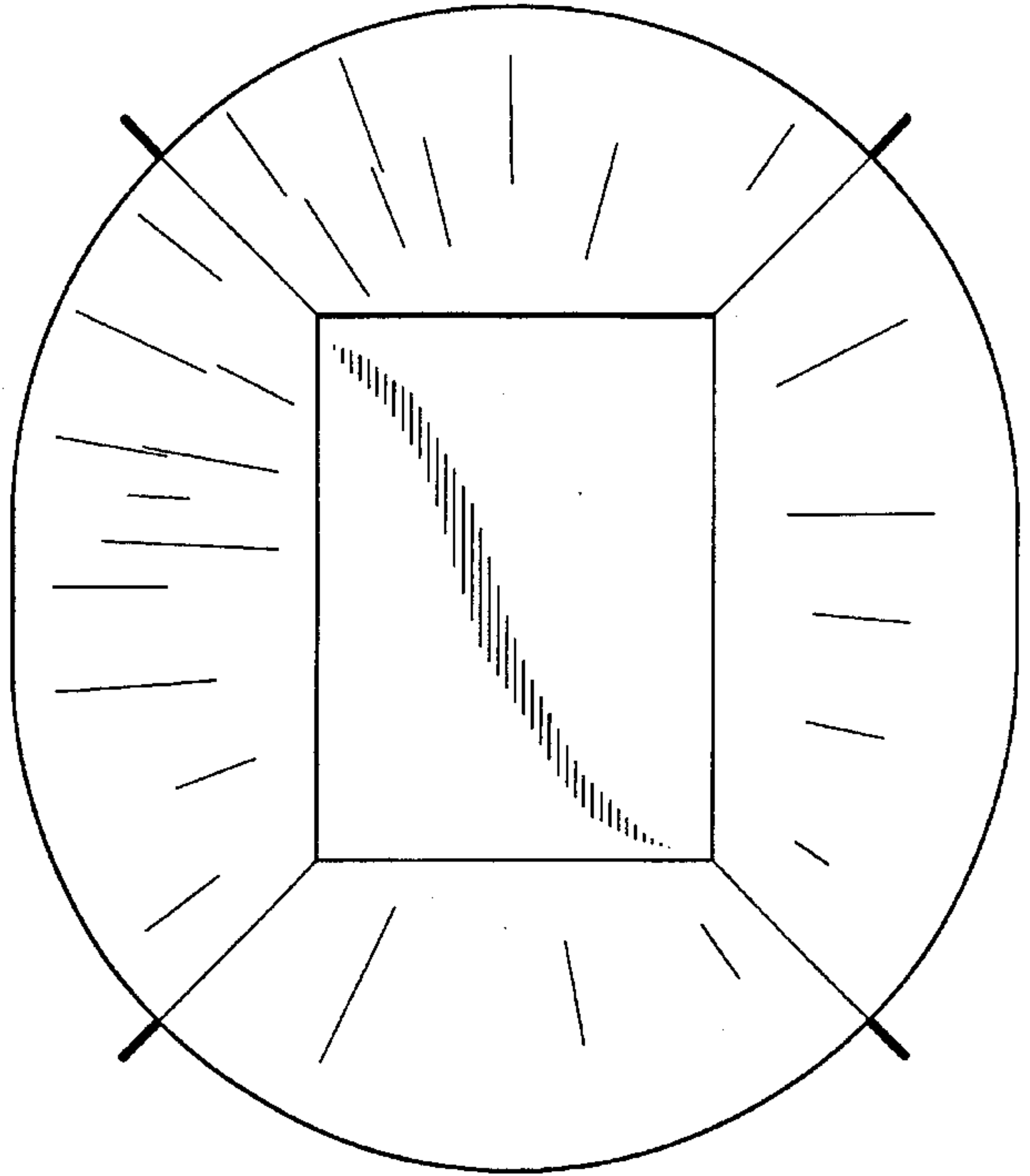

FIG. 32

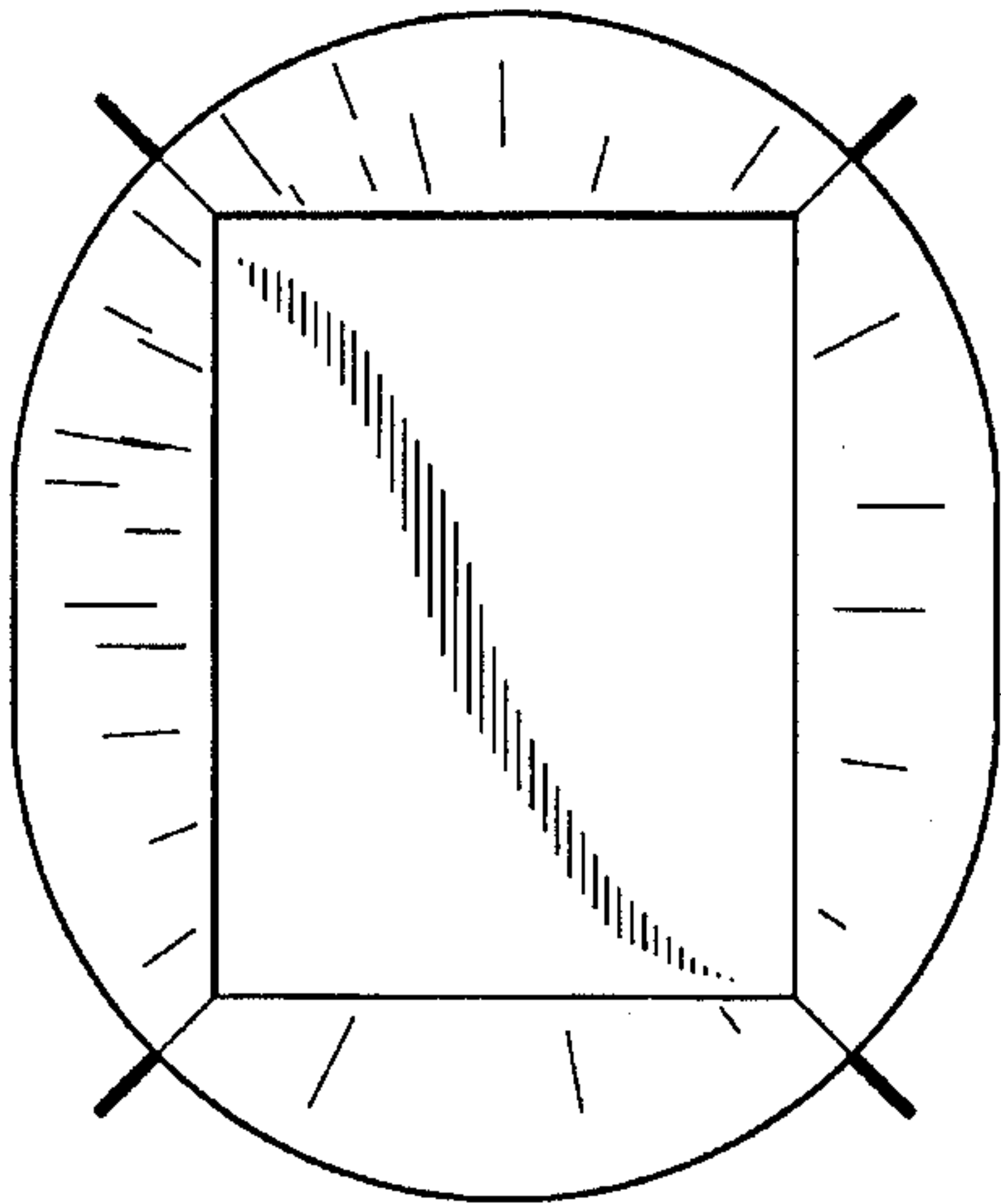

FIG. 33

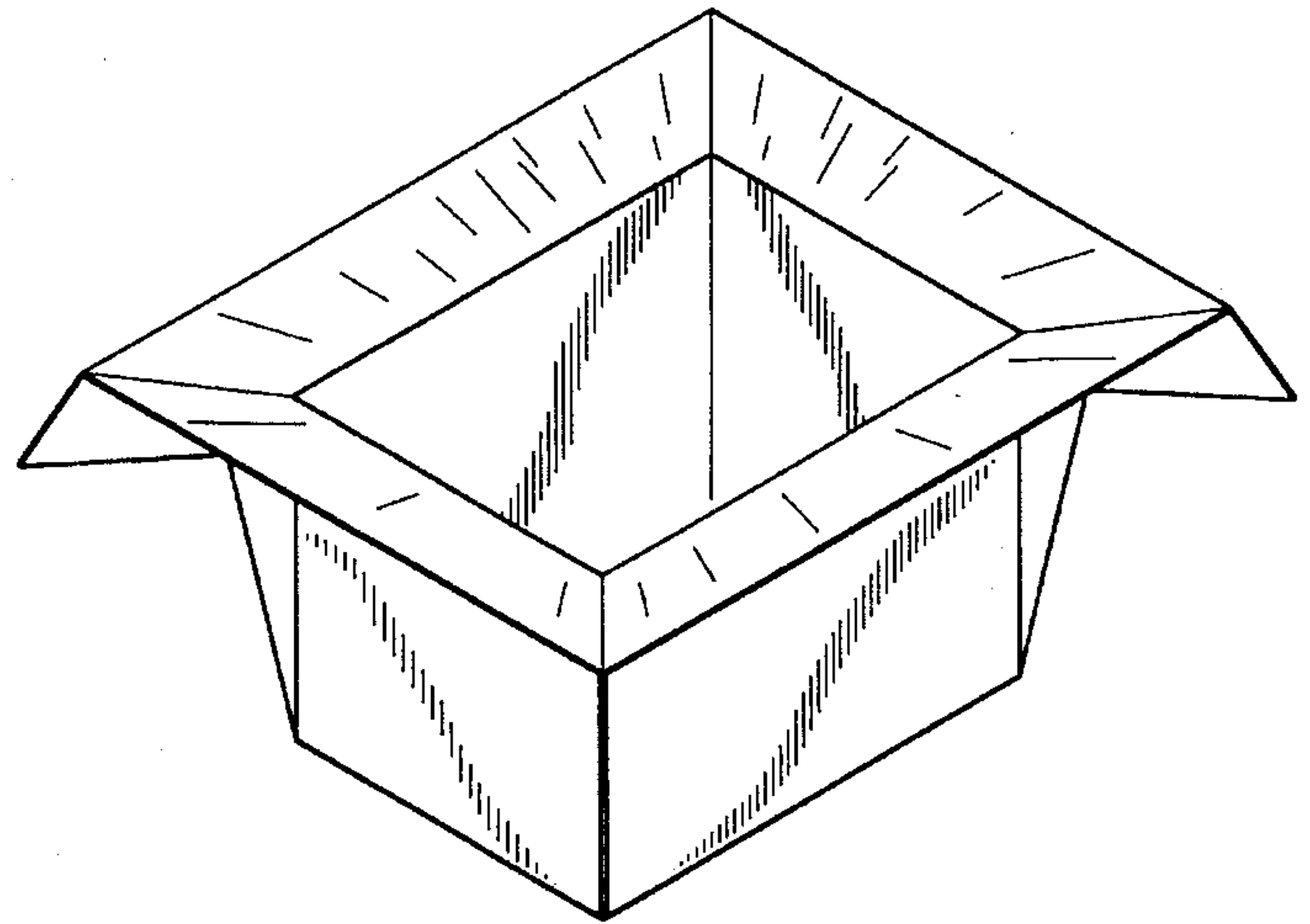

FIG. 34

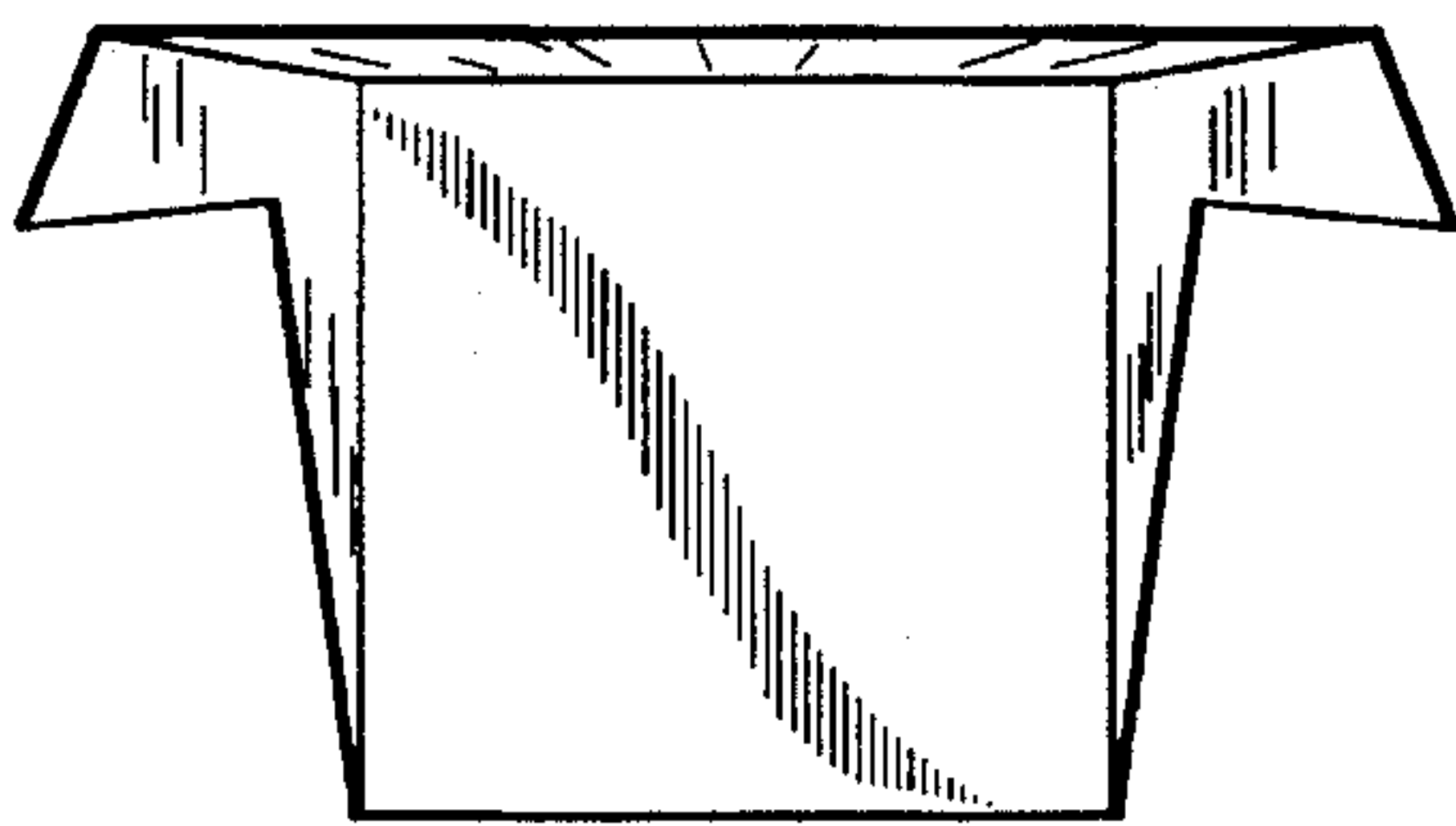

FIG. 35

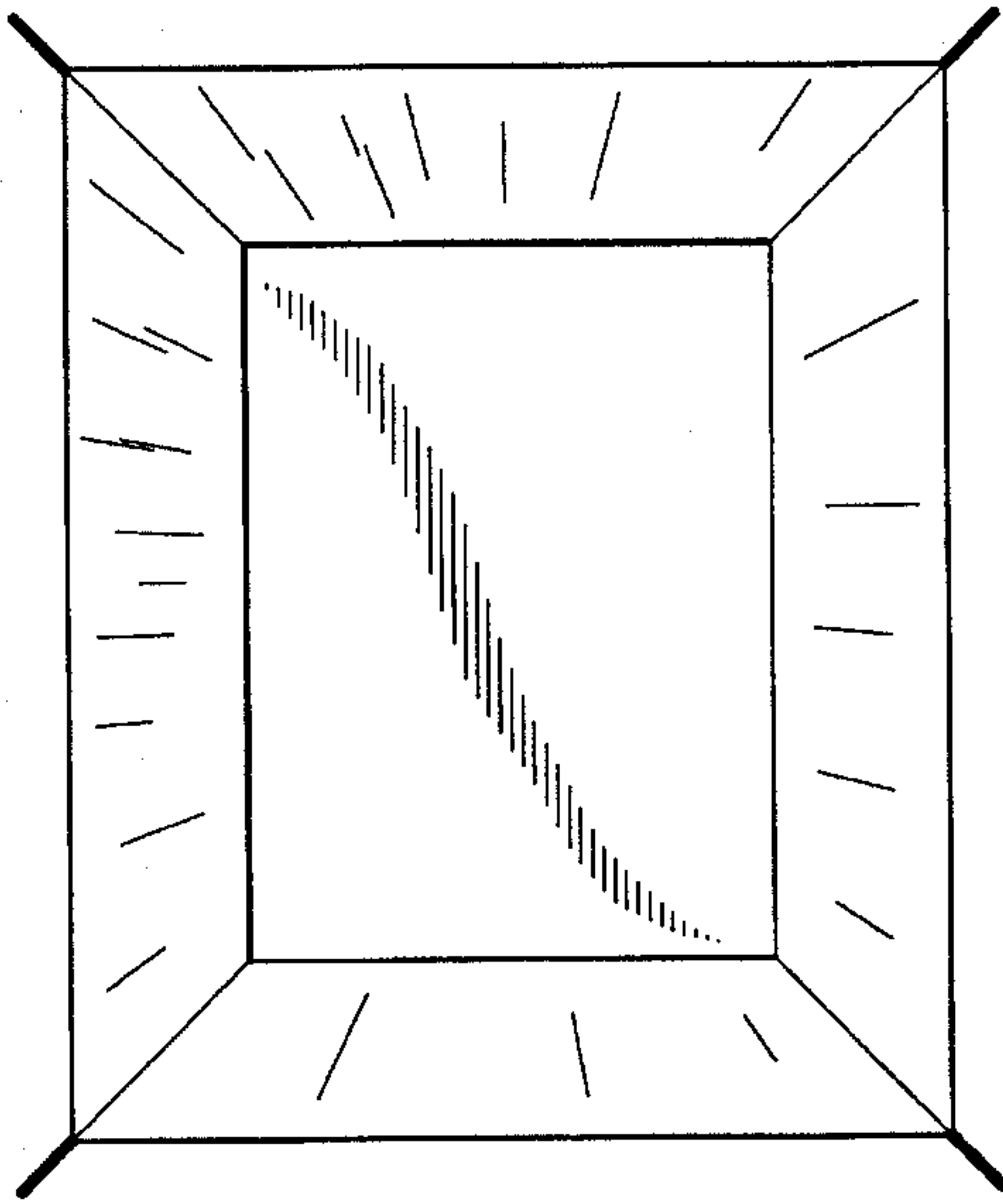

FIG. 36

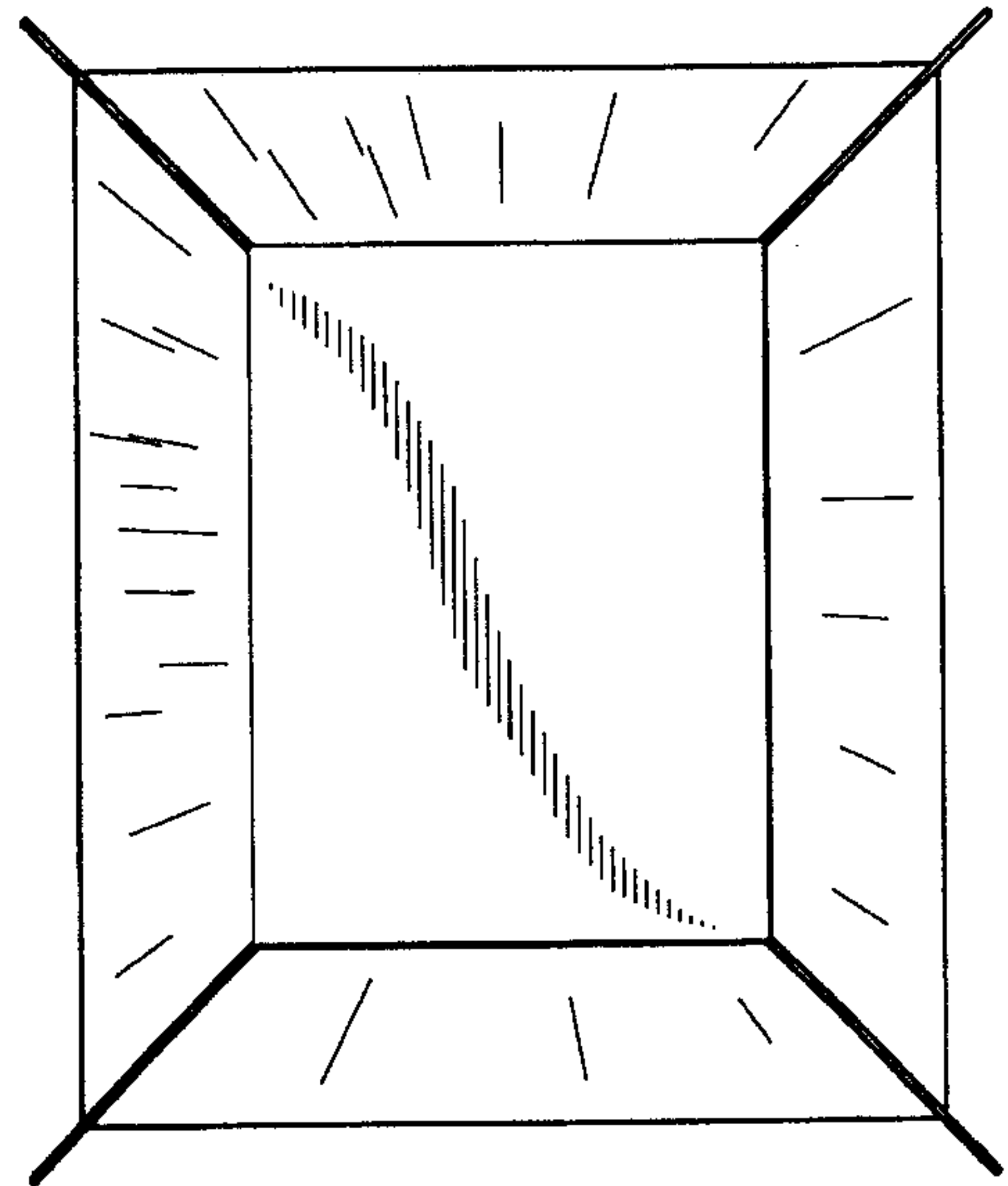

FIG. 37

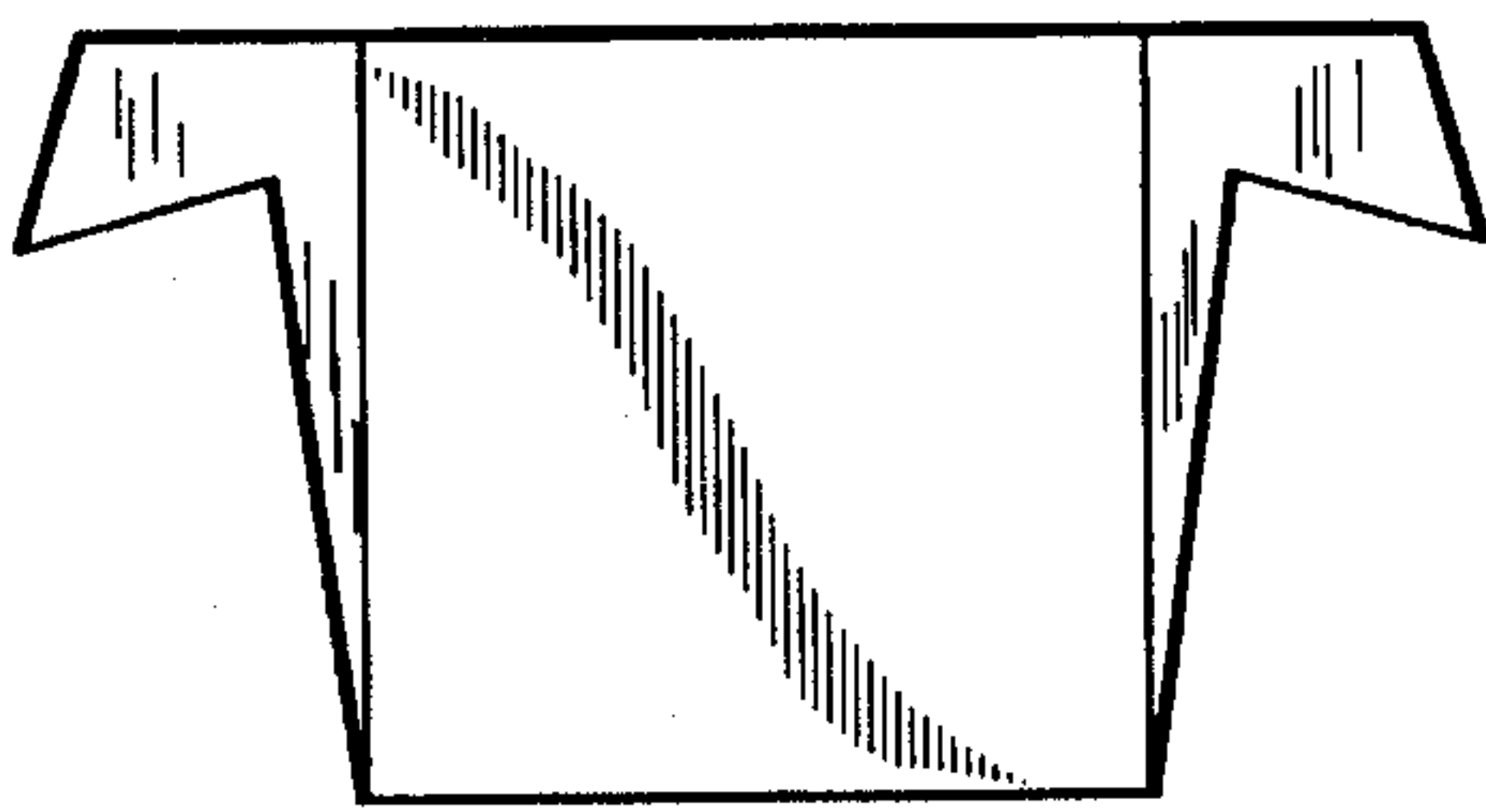

FIG. 38

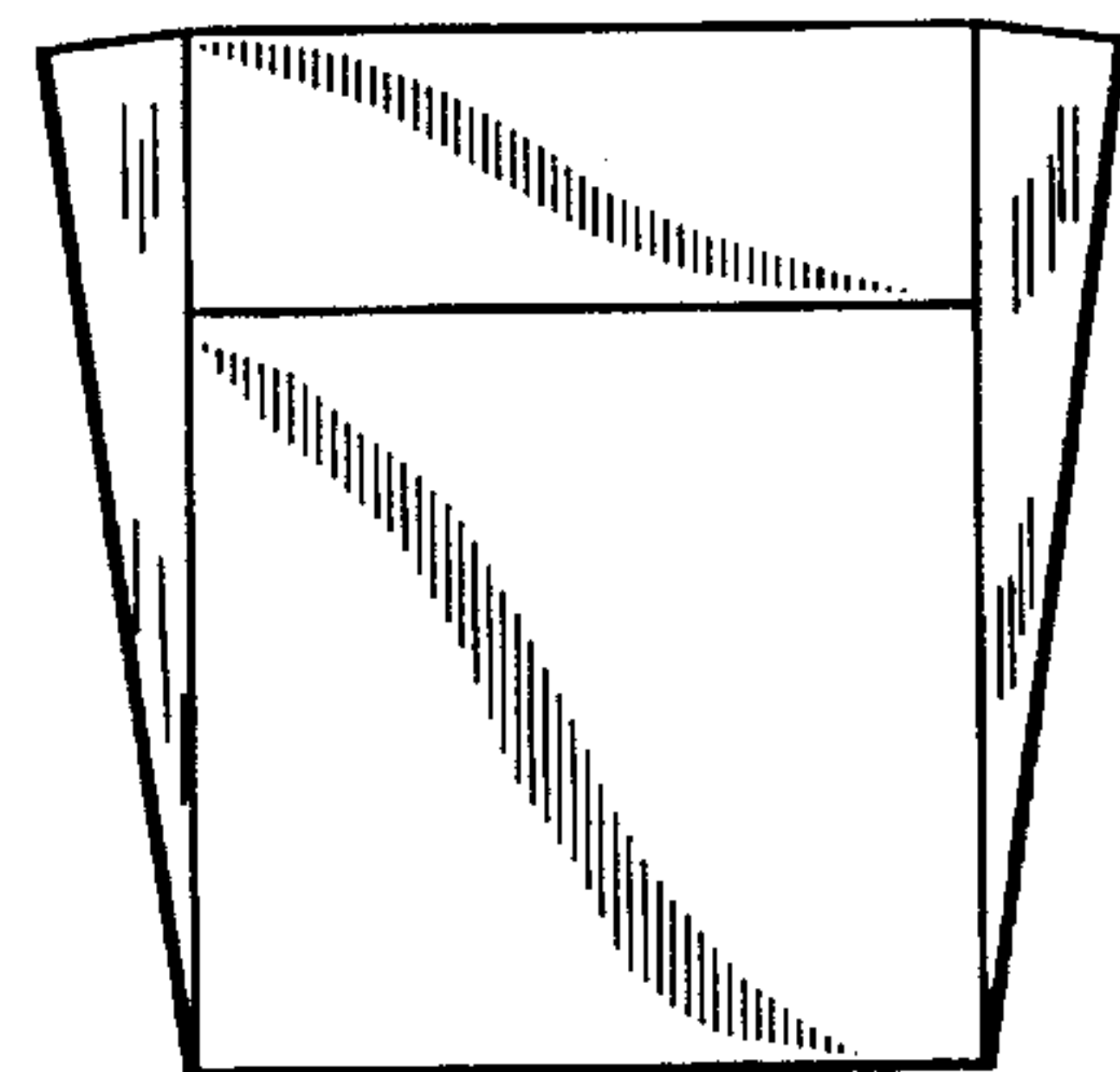

FIG. 39

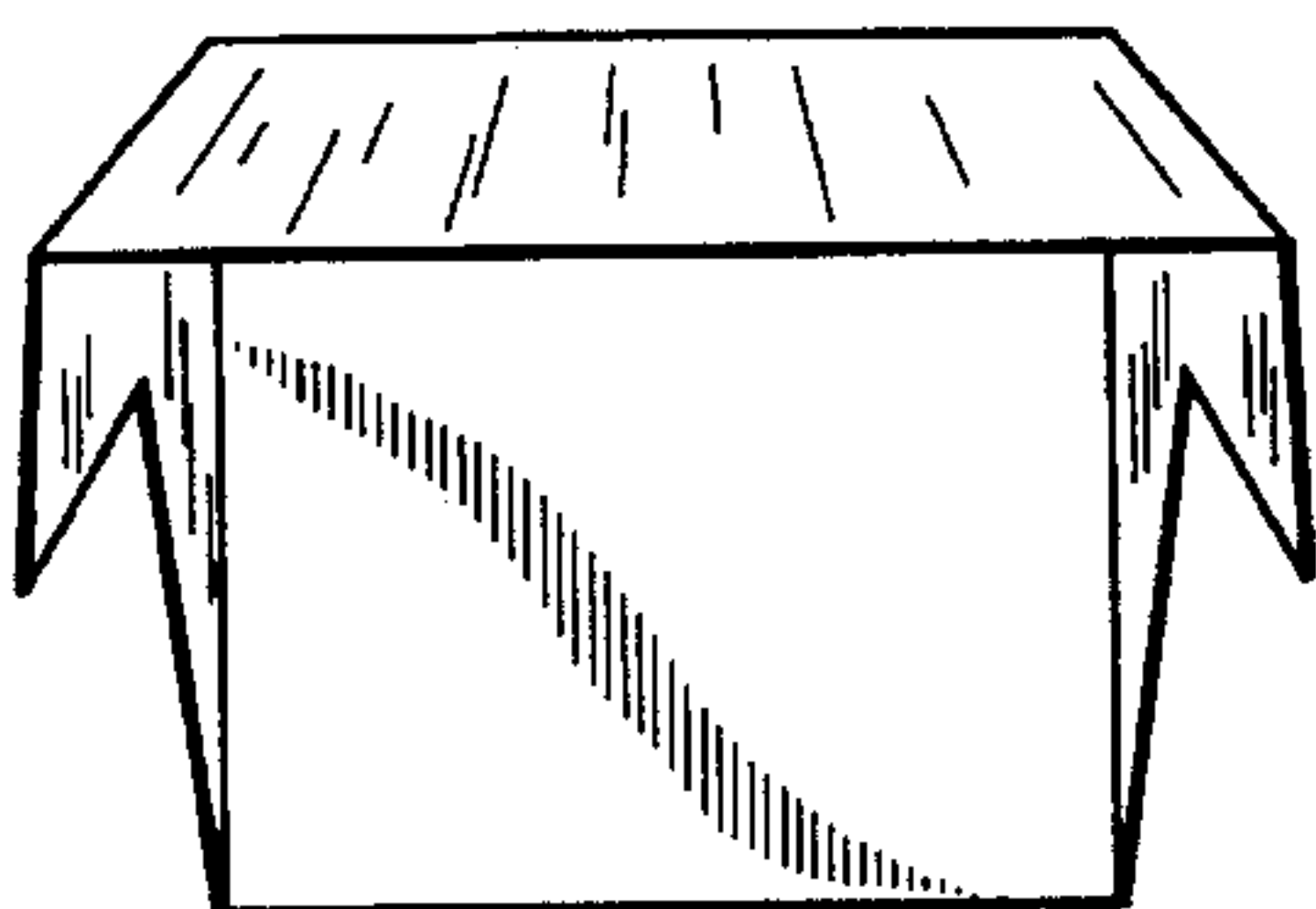

FIG. 40

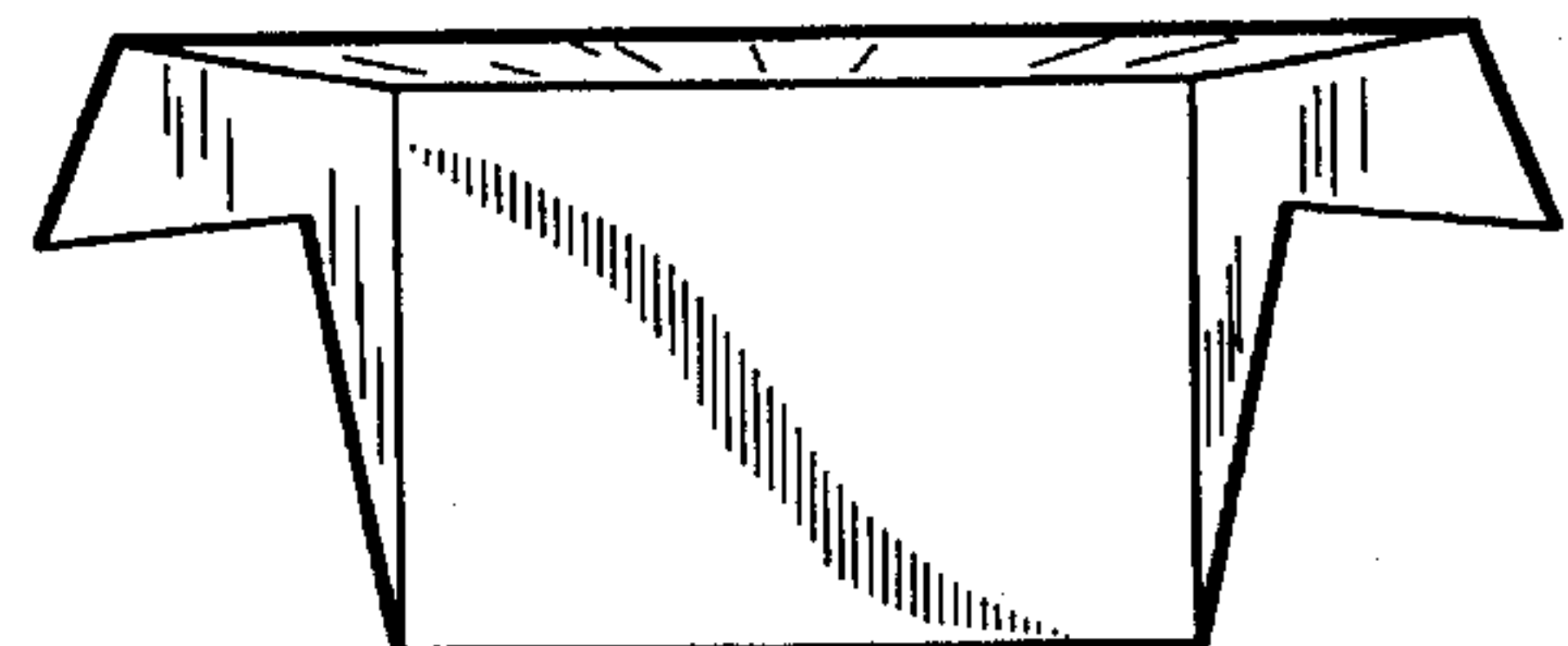

FIG. 41

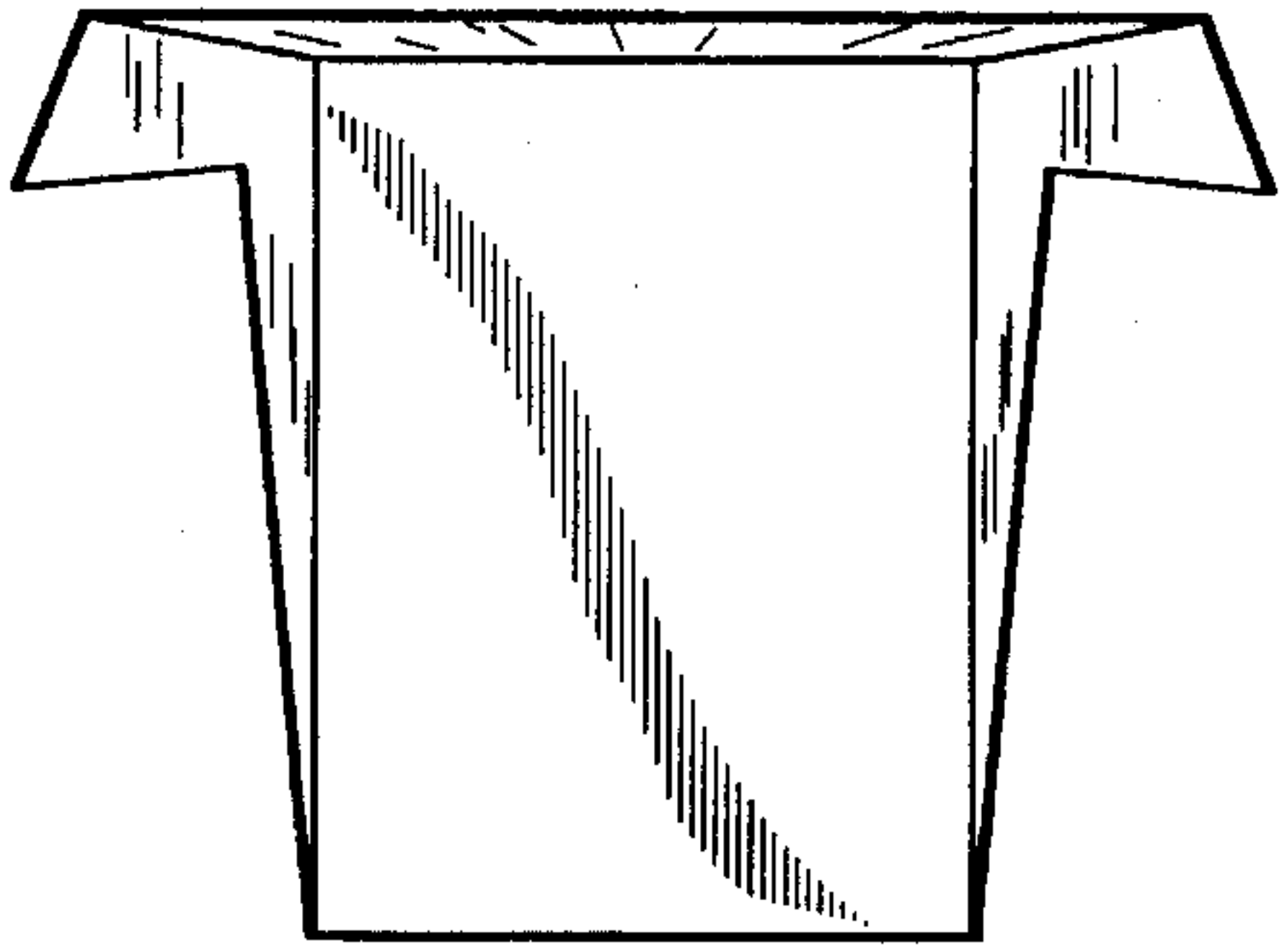

FIG. 42

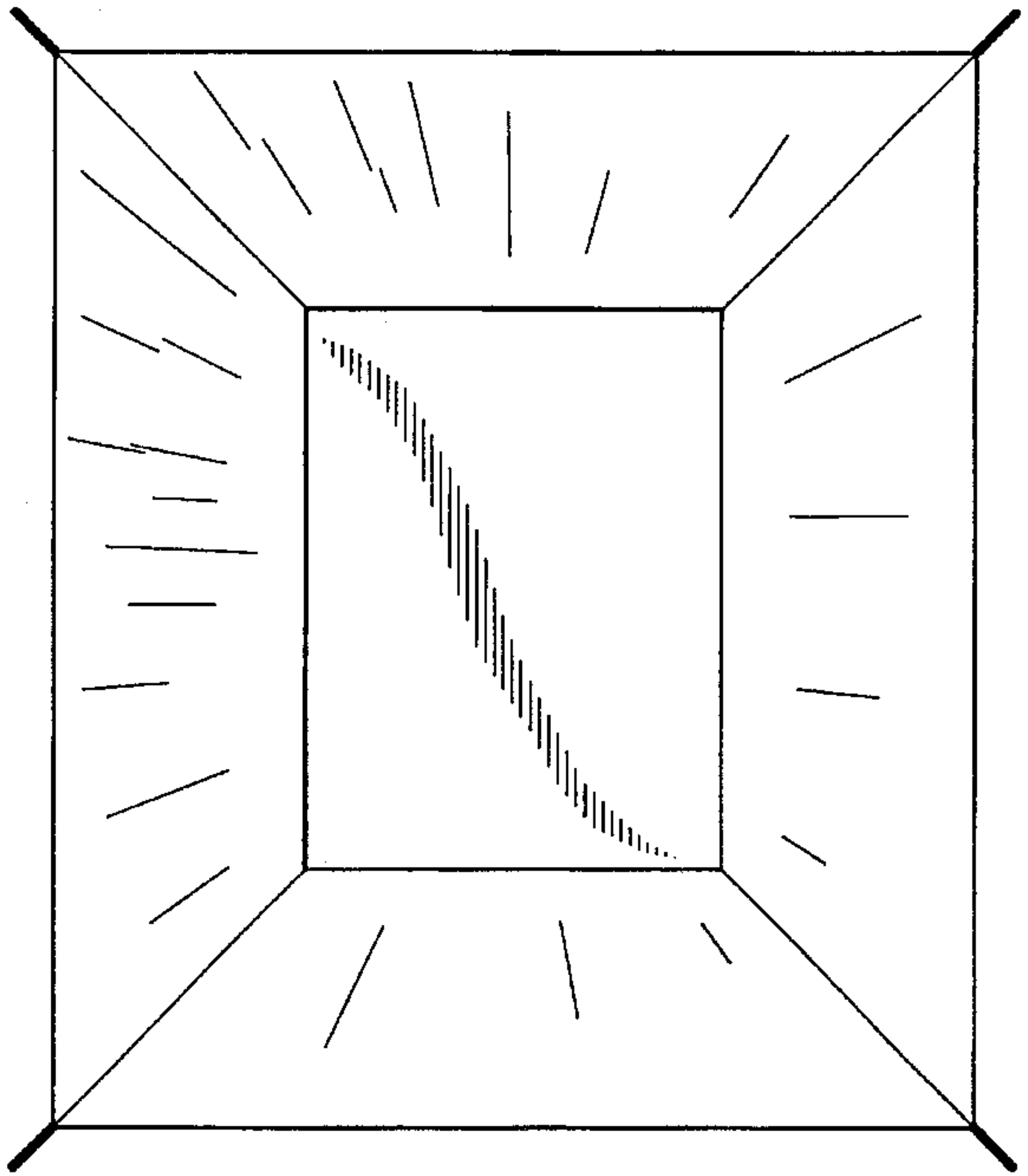

FIG. 43

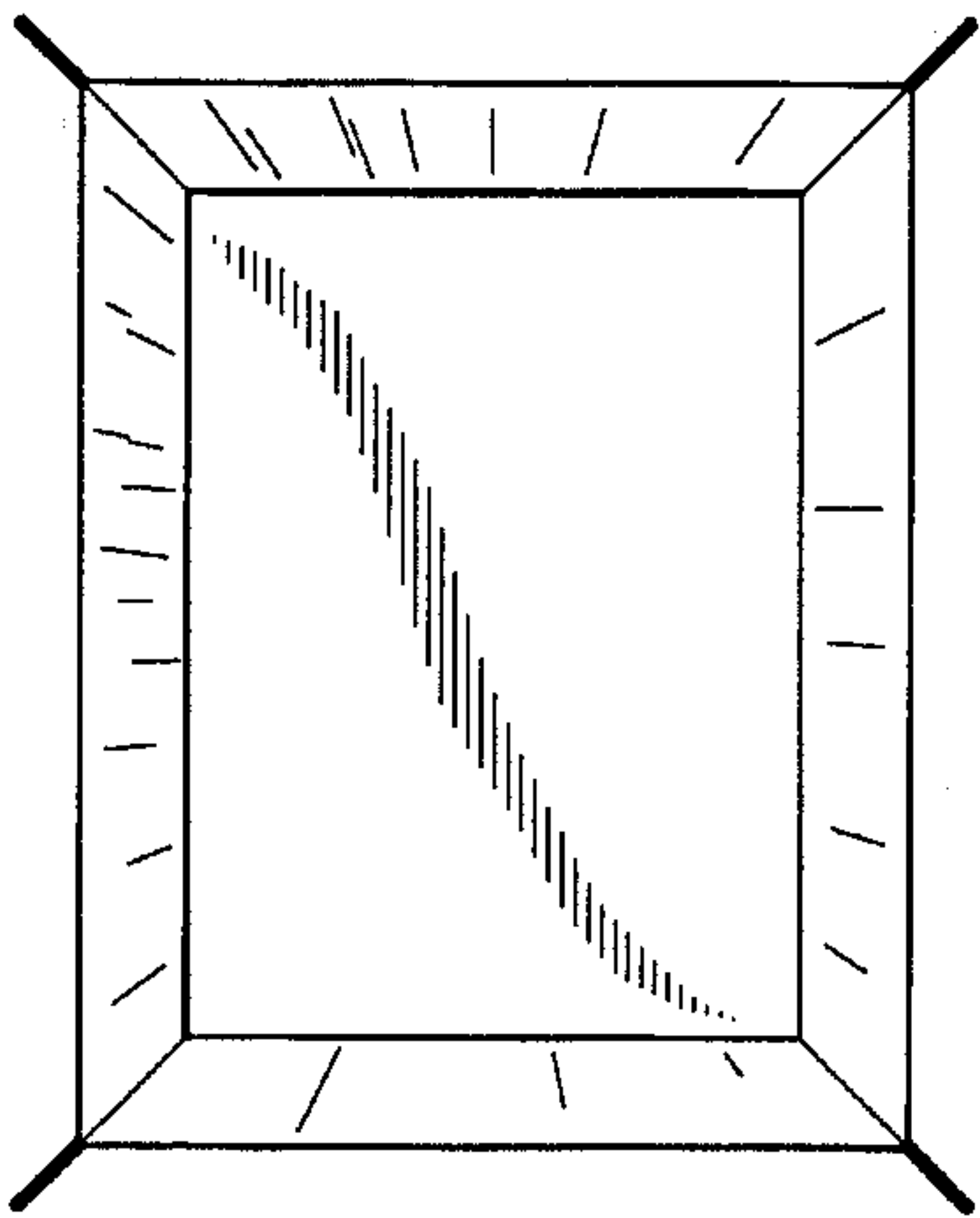

FIG. 44

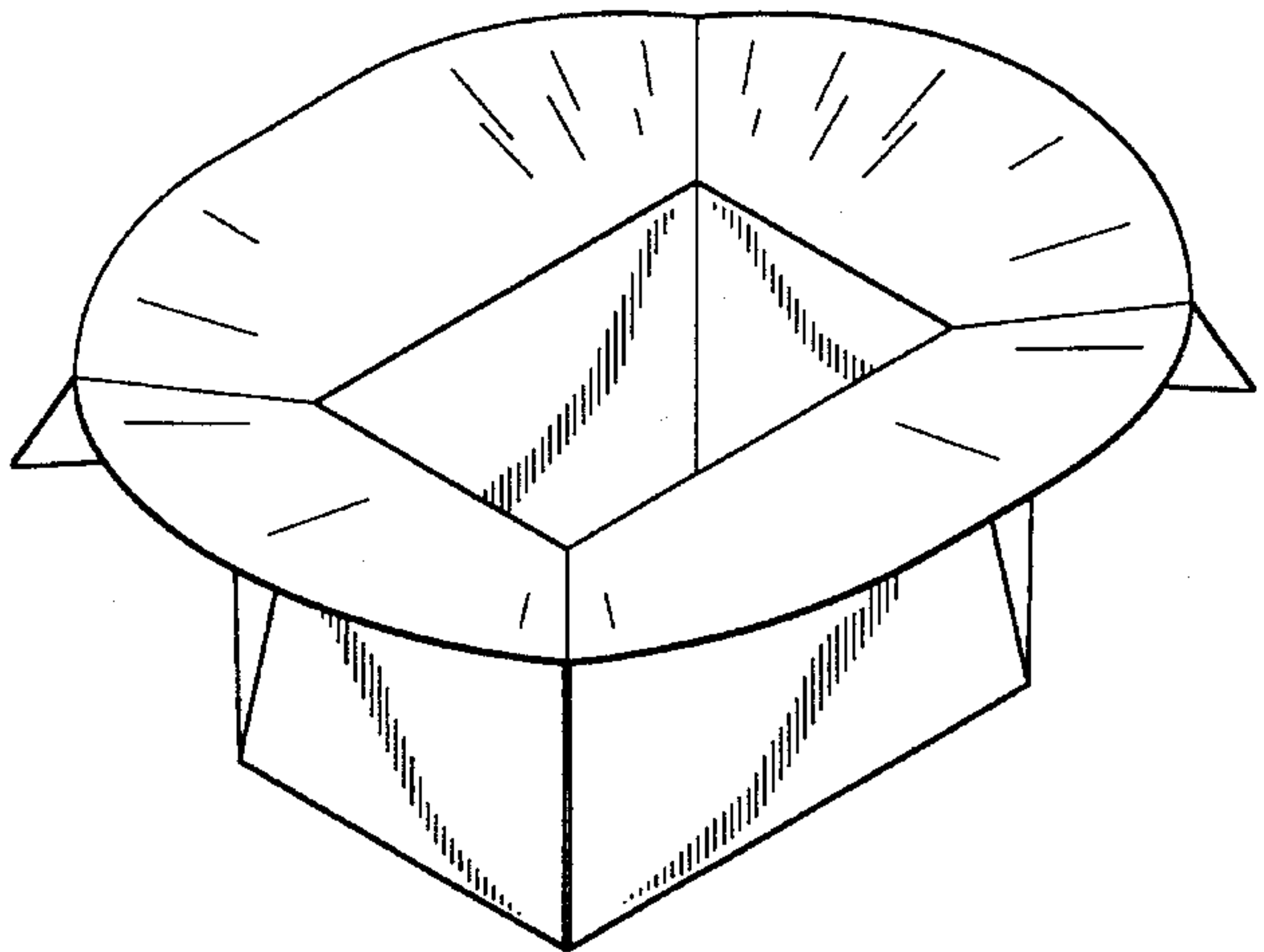

FIG. 45

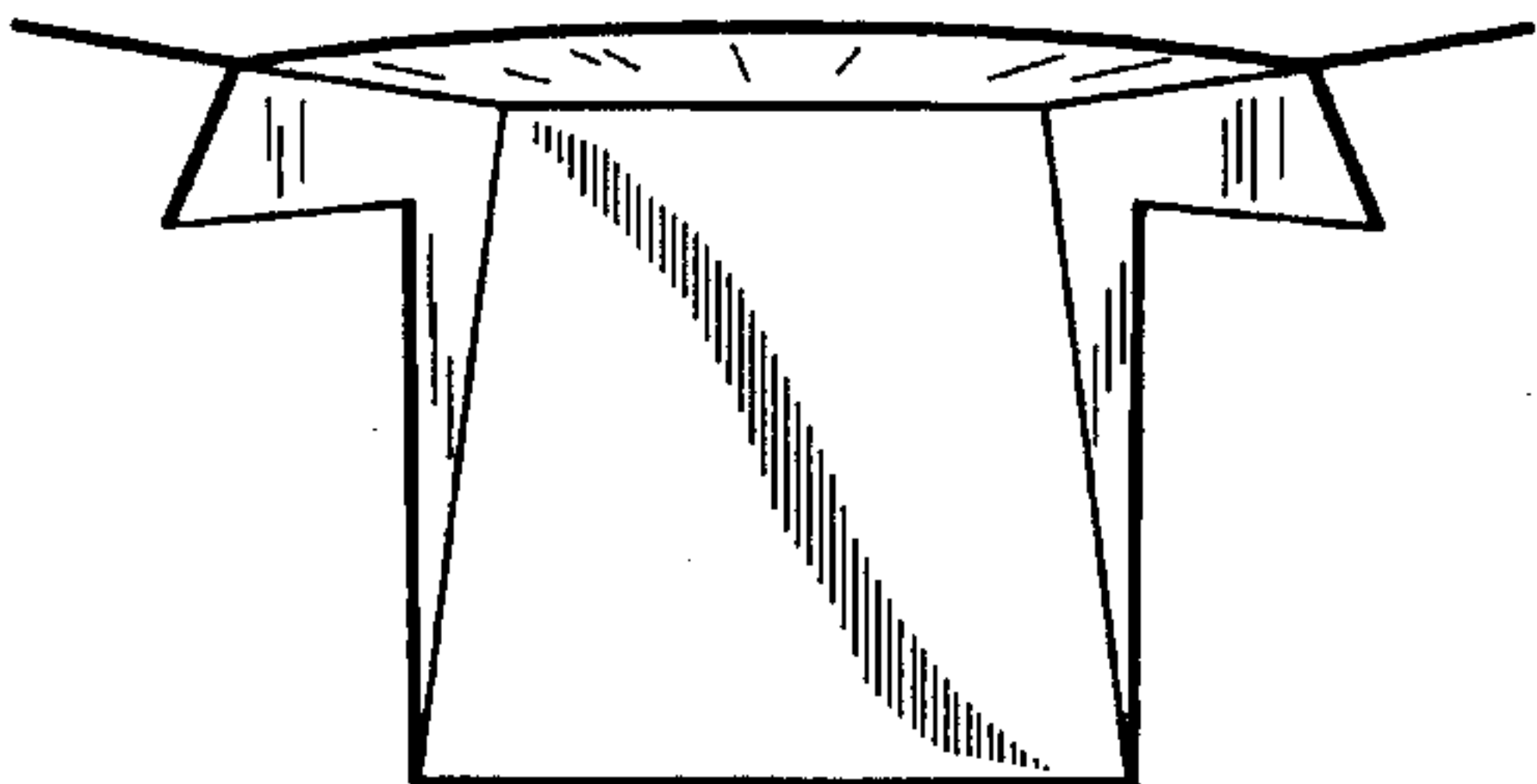

FIG. 46

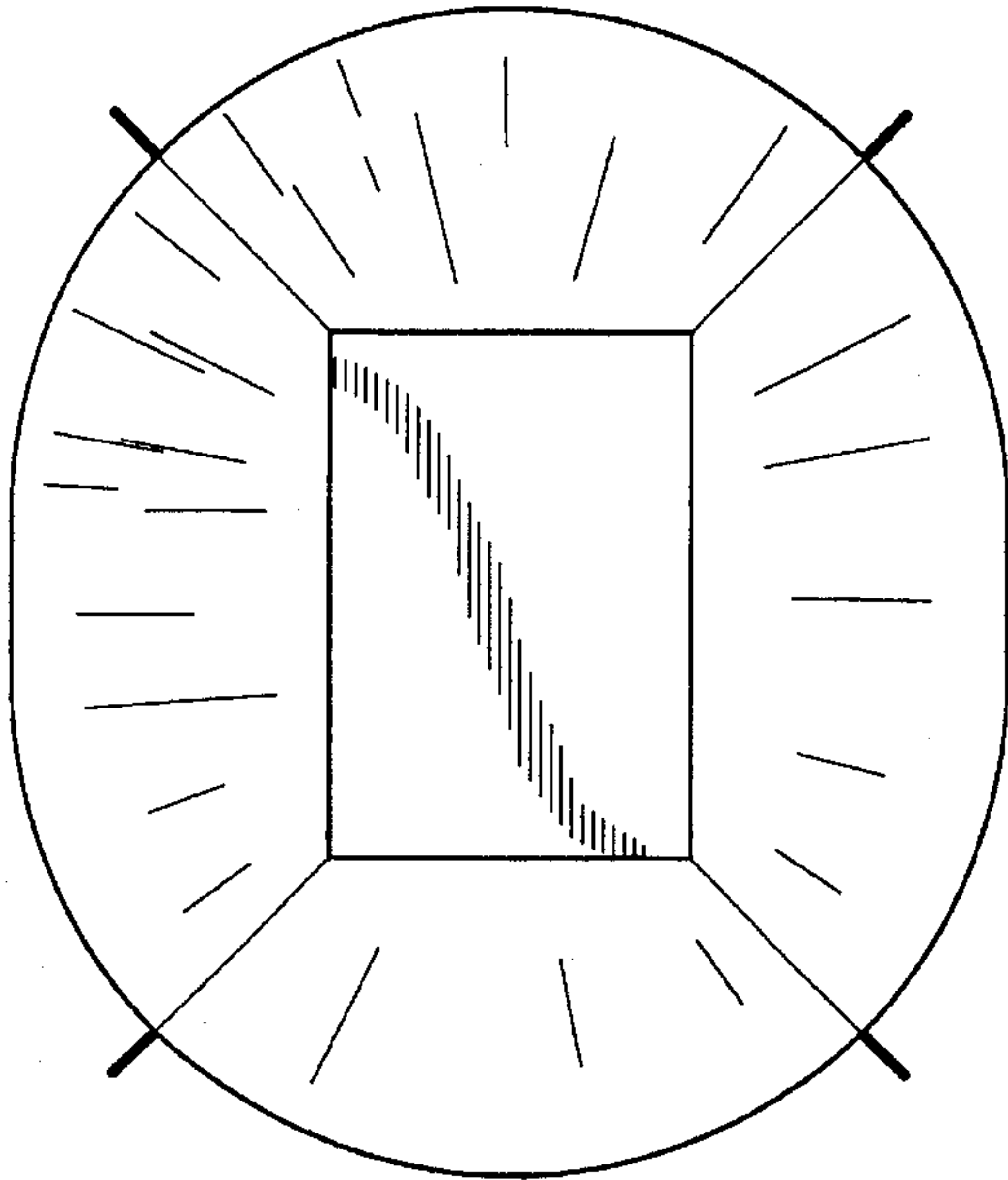

FIG. 47

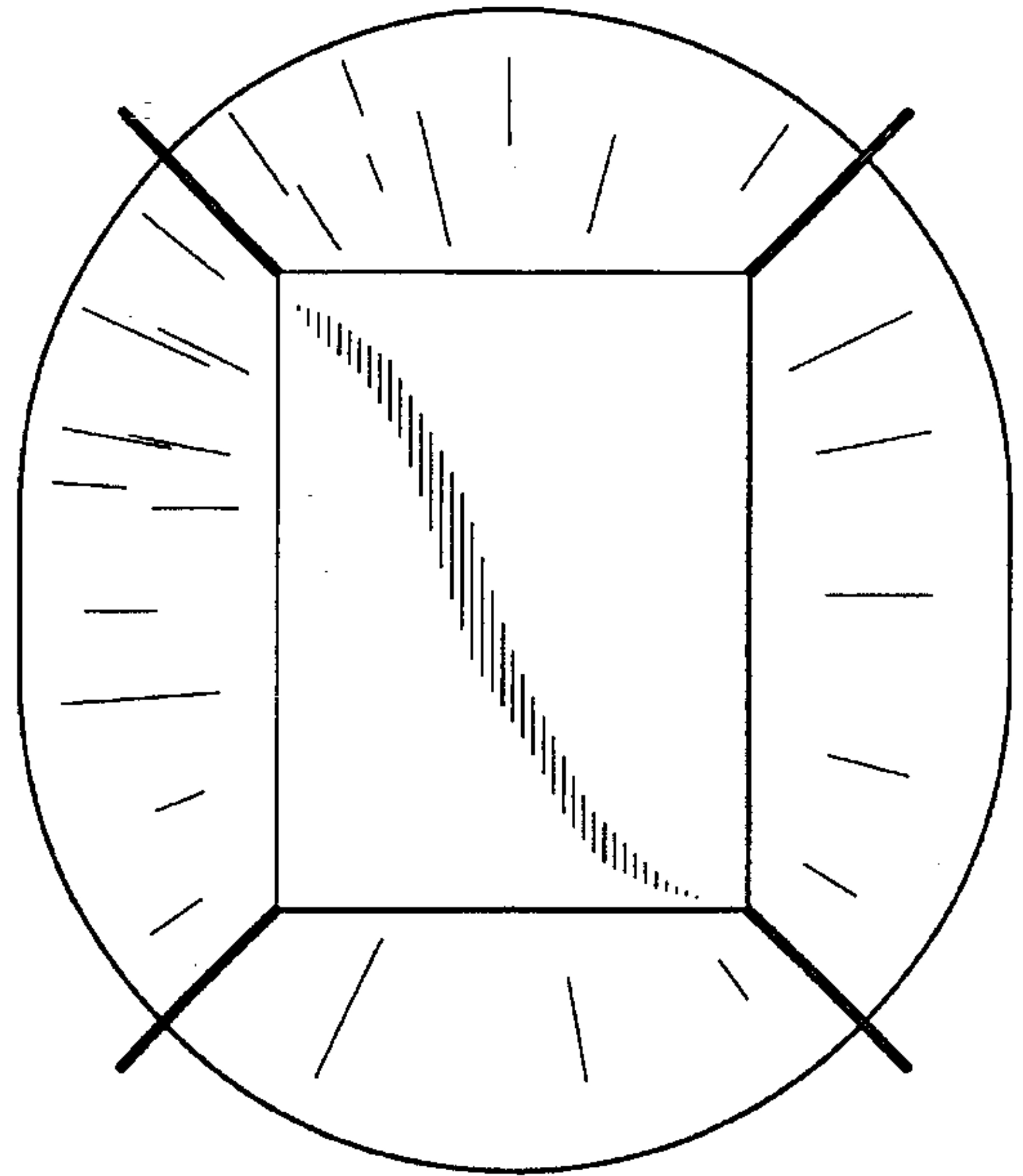

FIG. 48

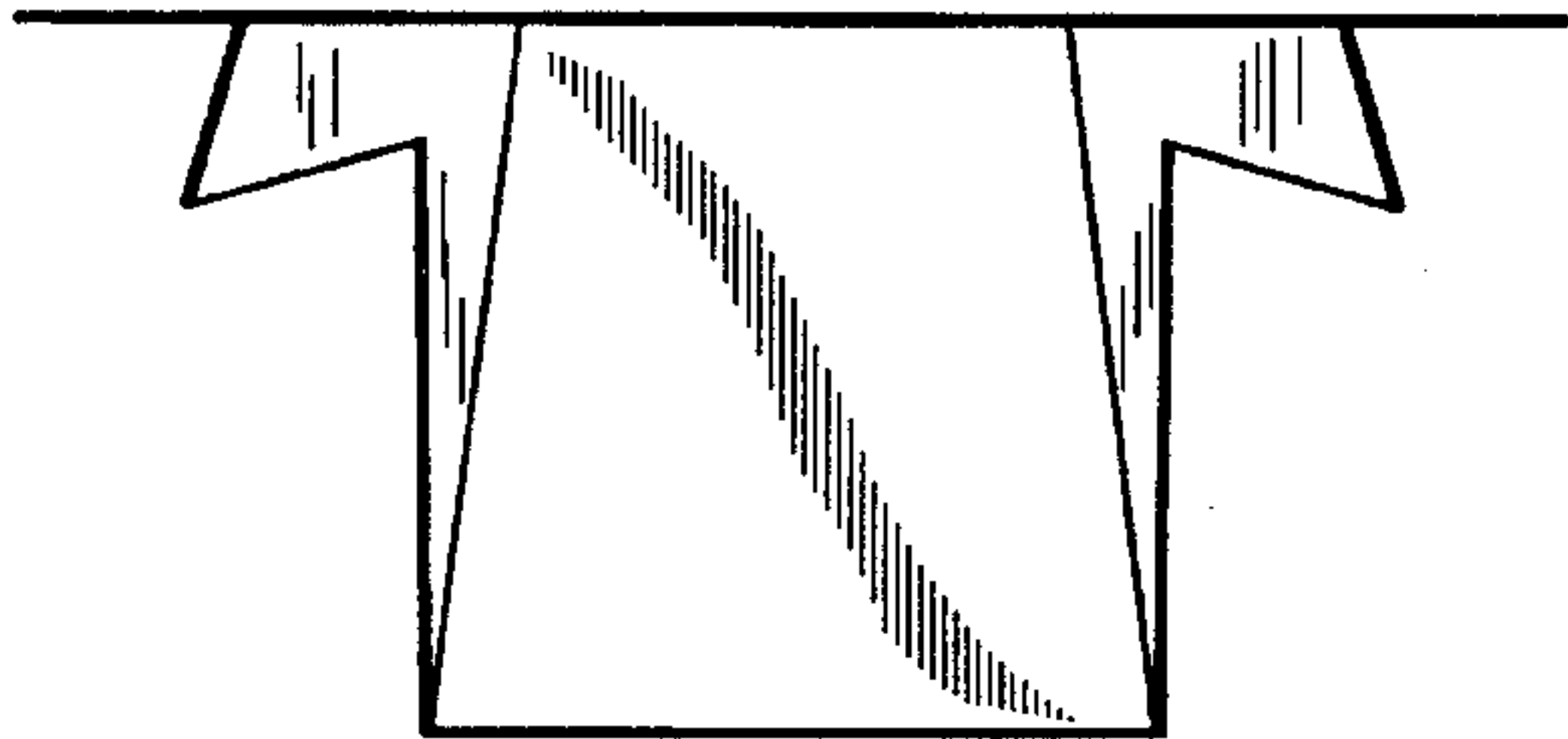

FIG. 49

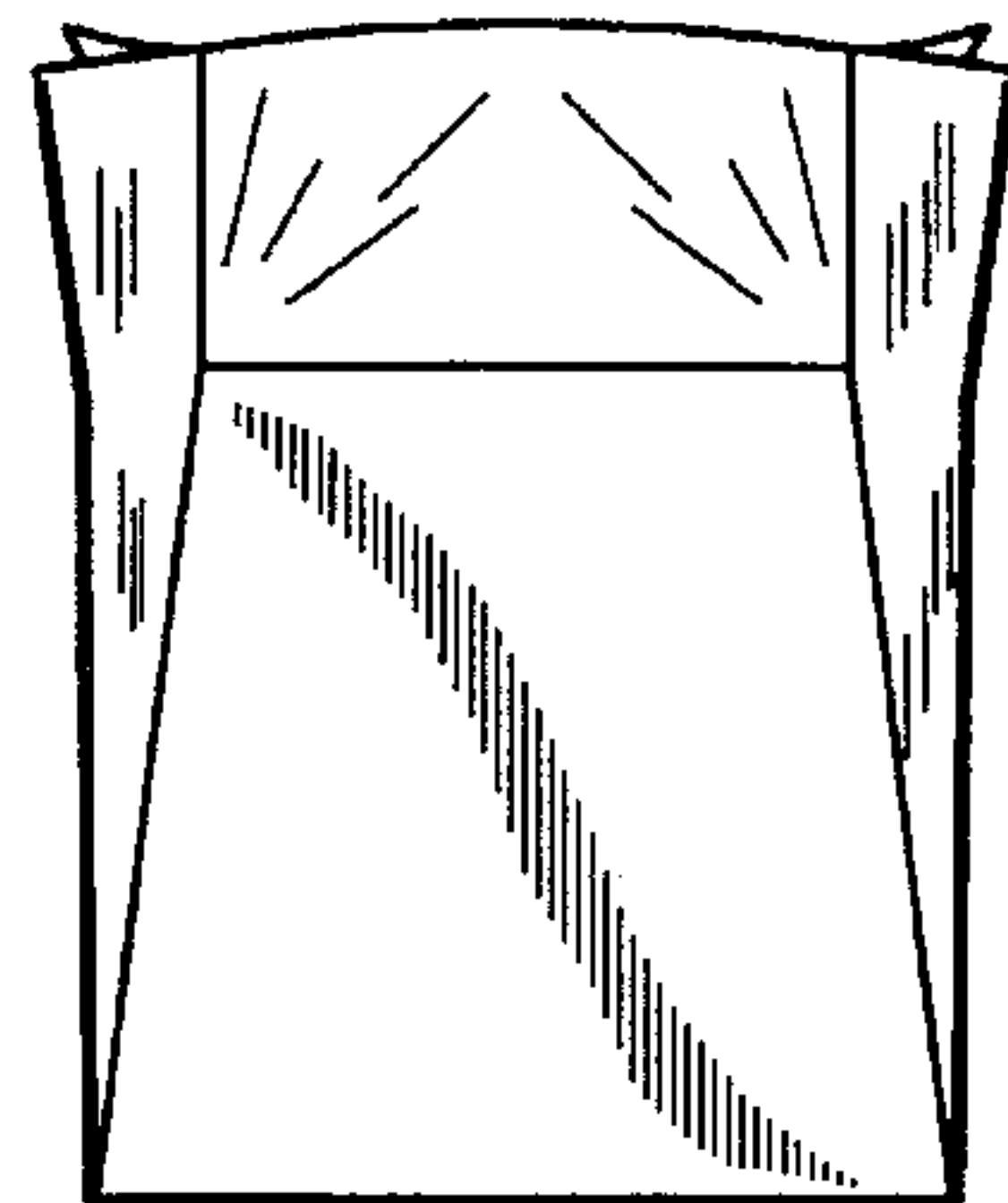

FIG. 50

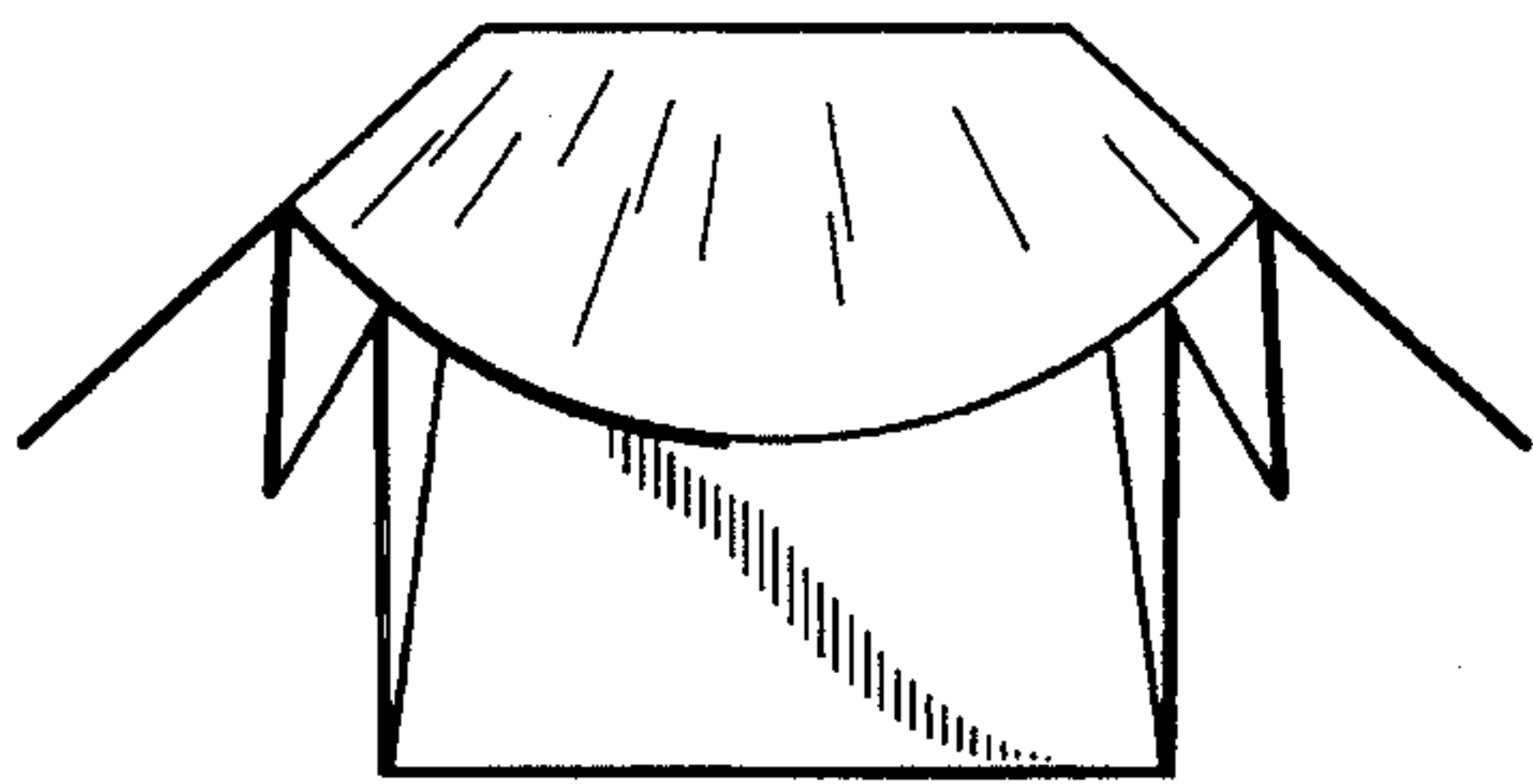

FIG. 51

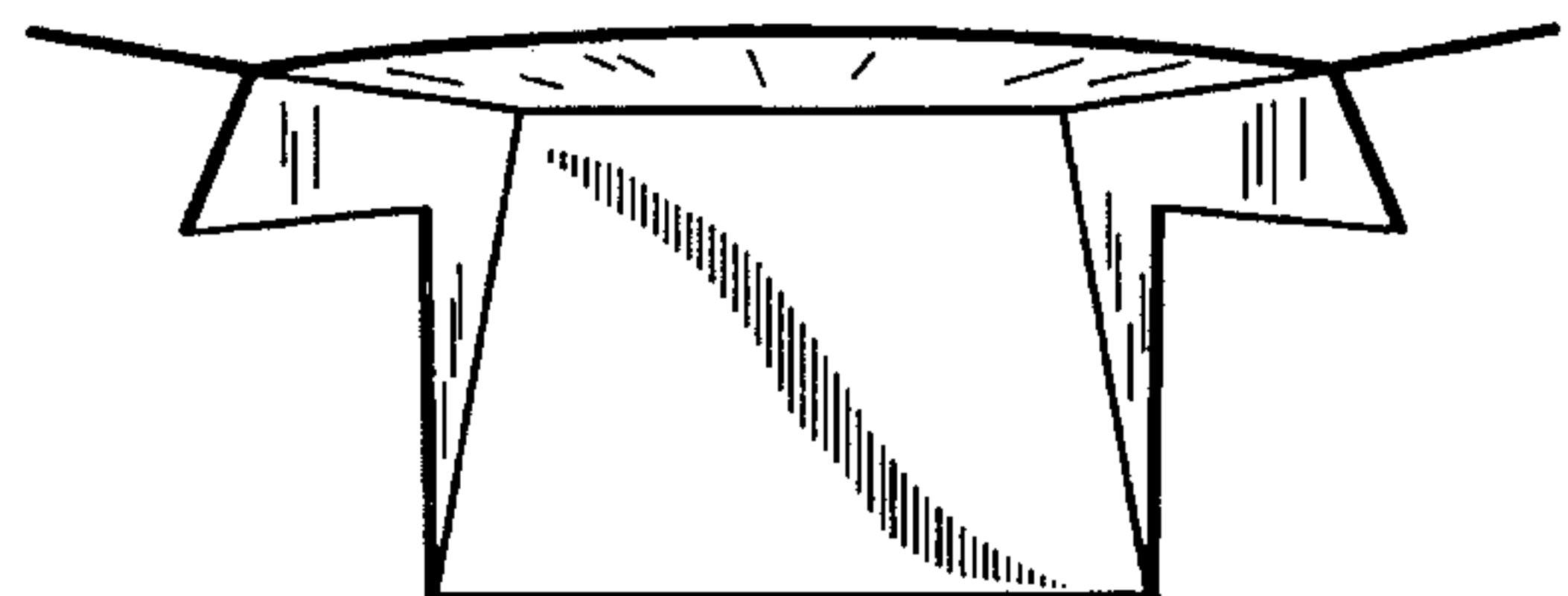

FIG. 52

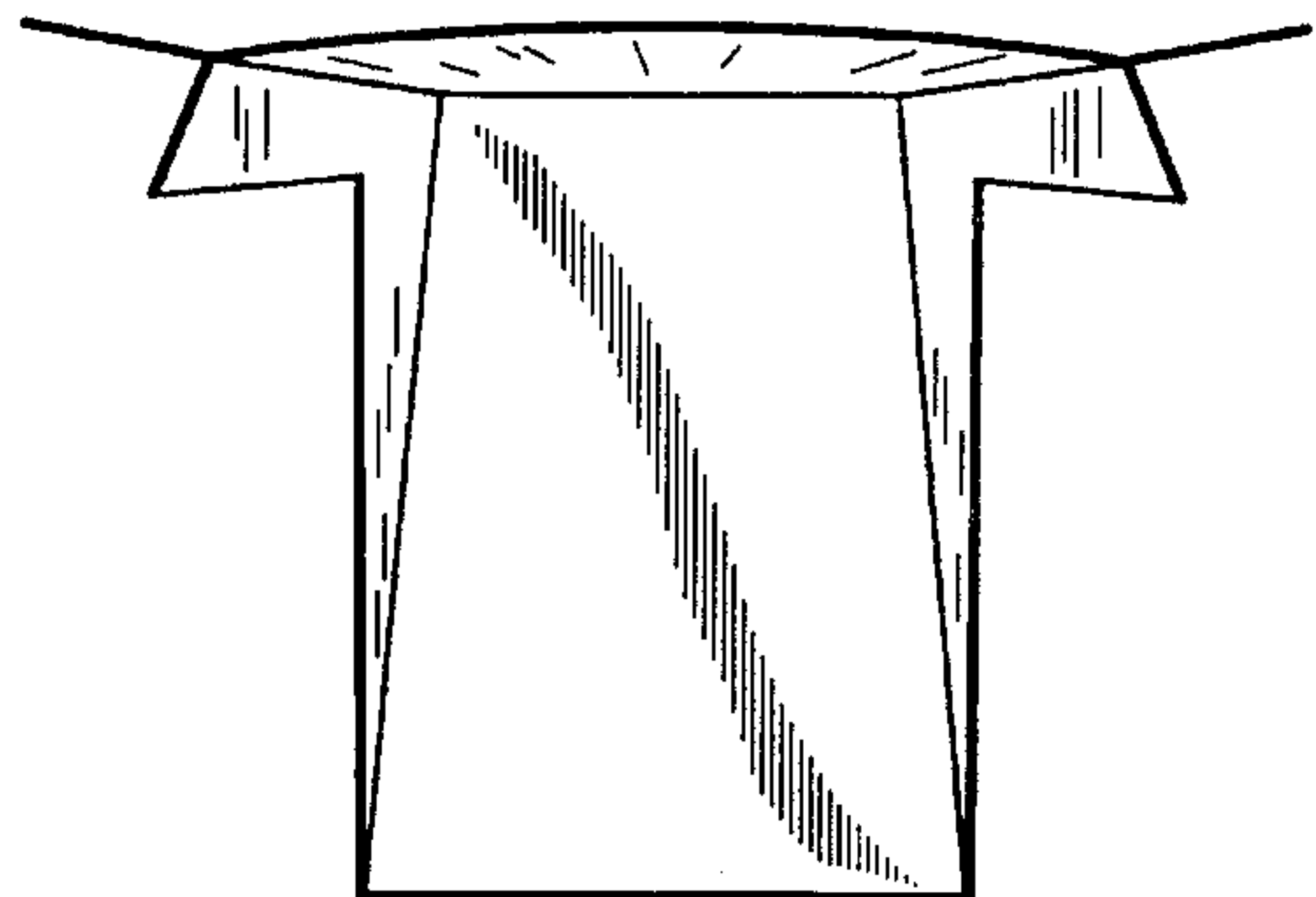

FIG. 53

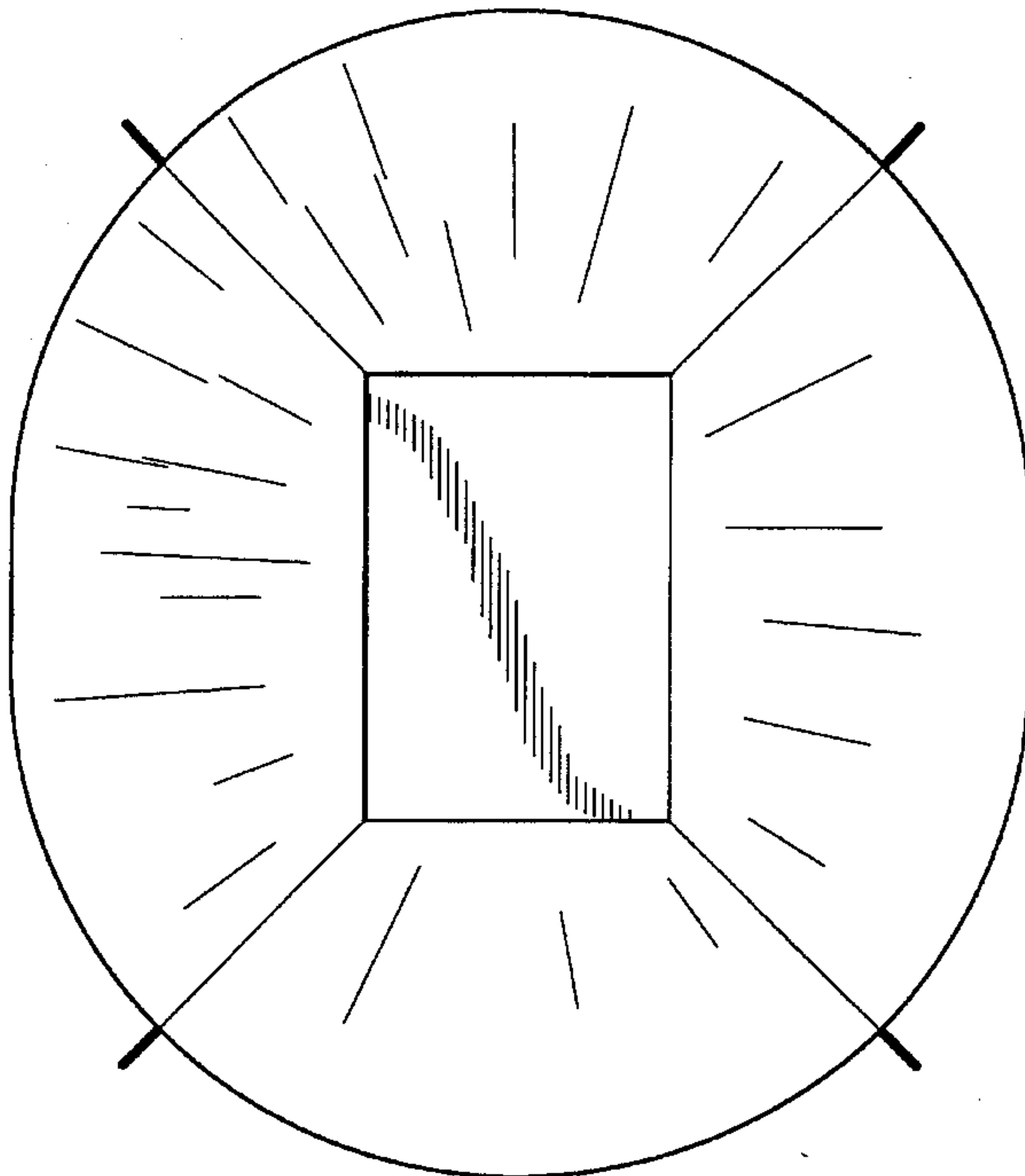

FIG. 54

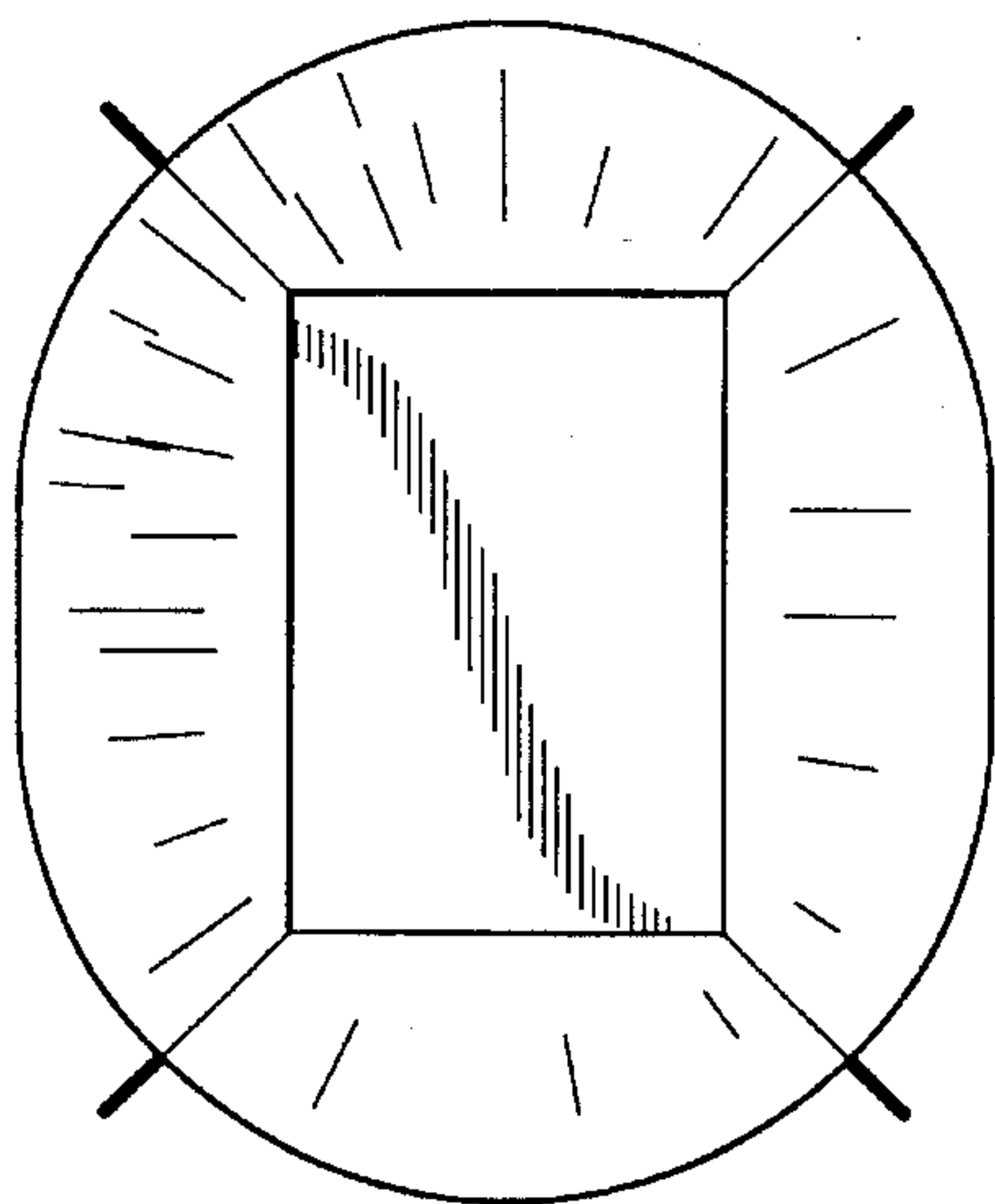

FIG. 55

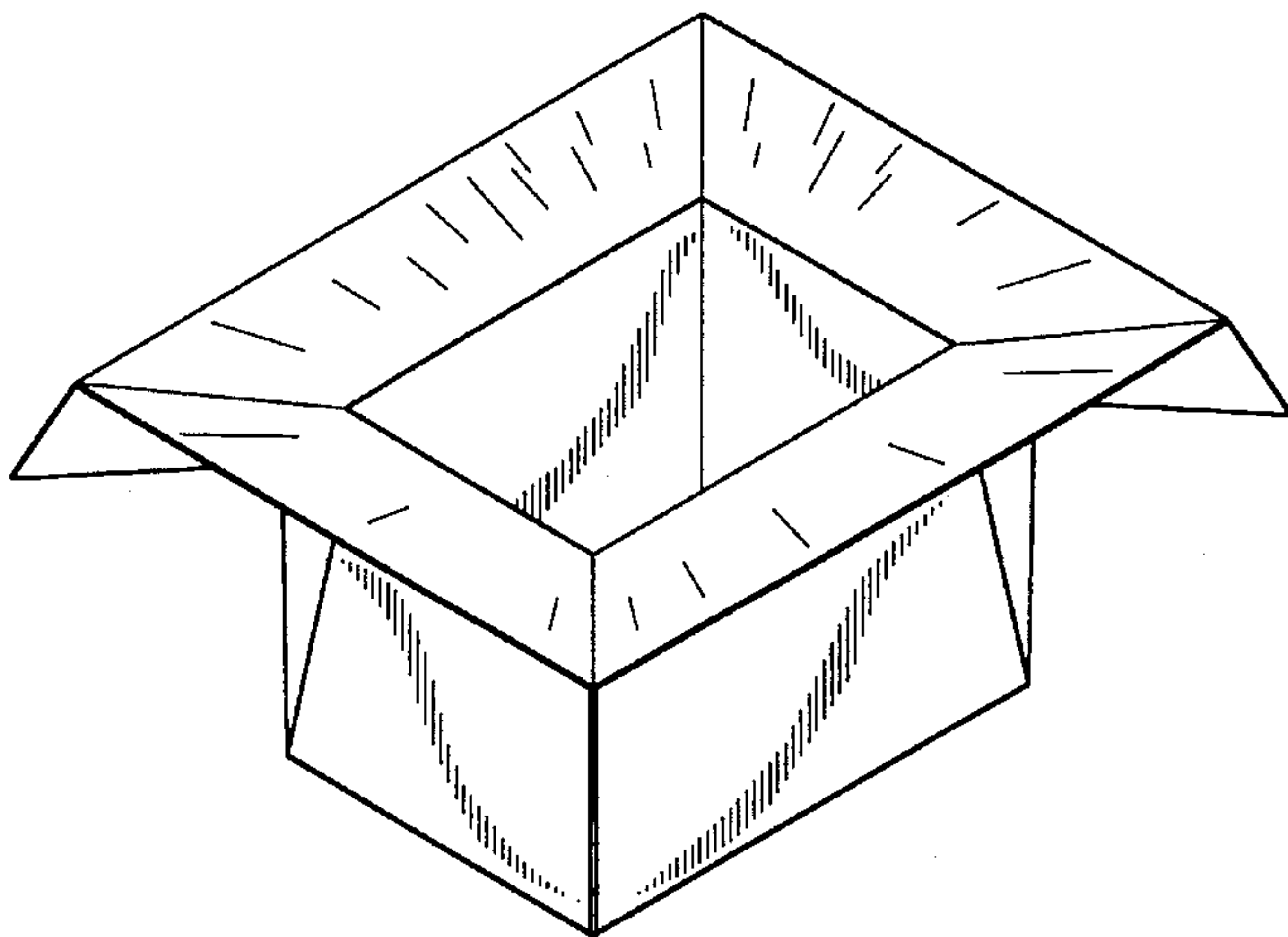

FIG. 56

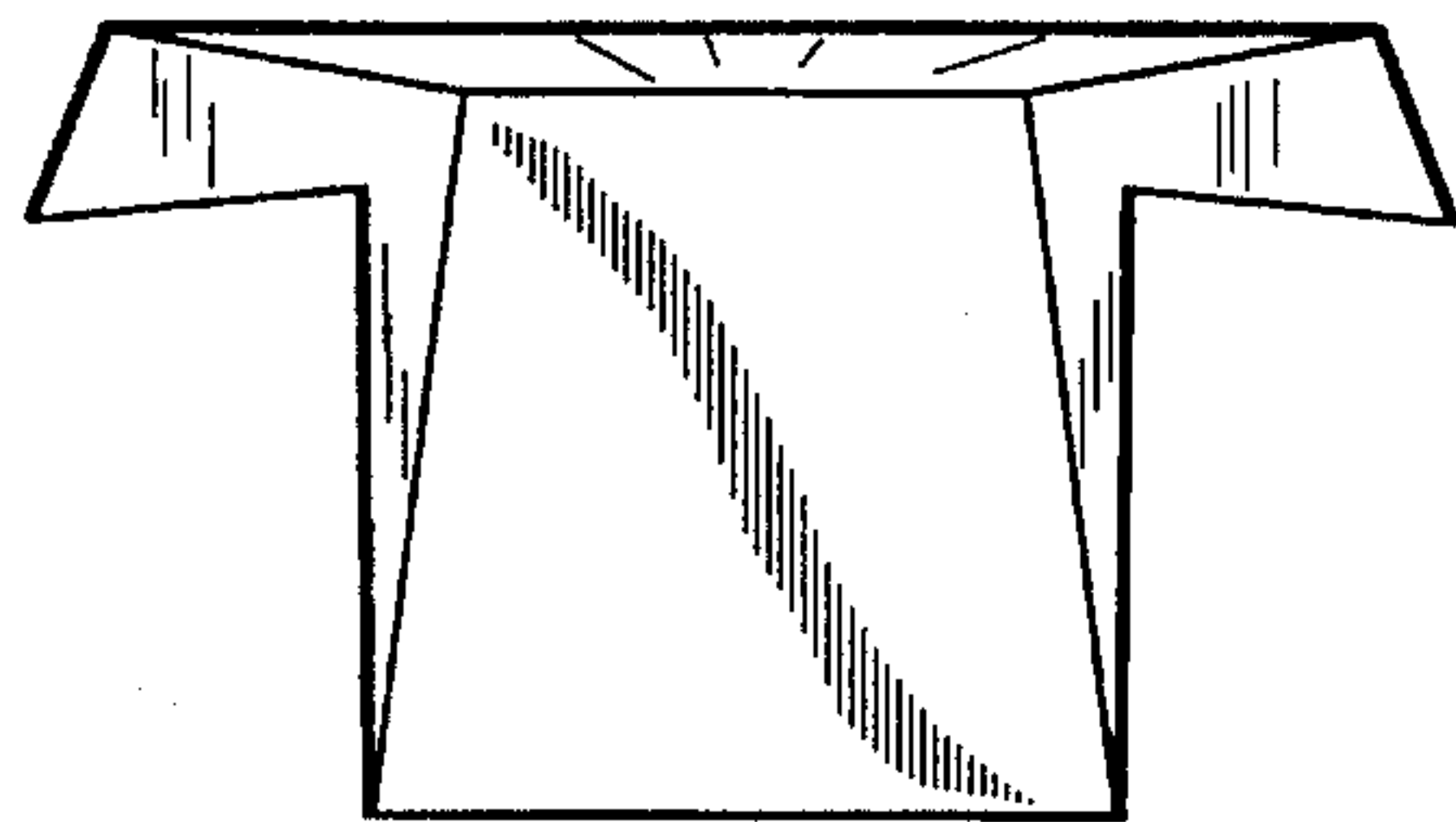

FIG. 57

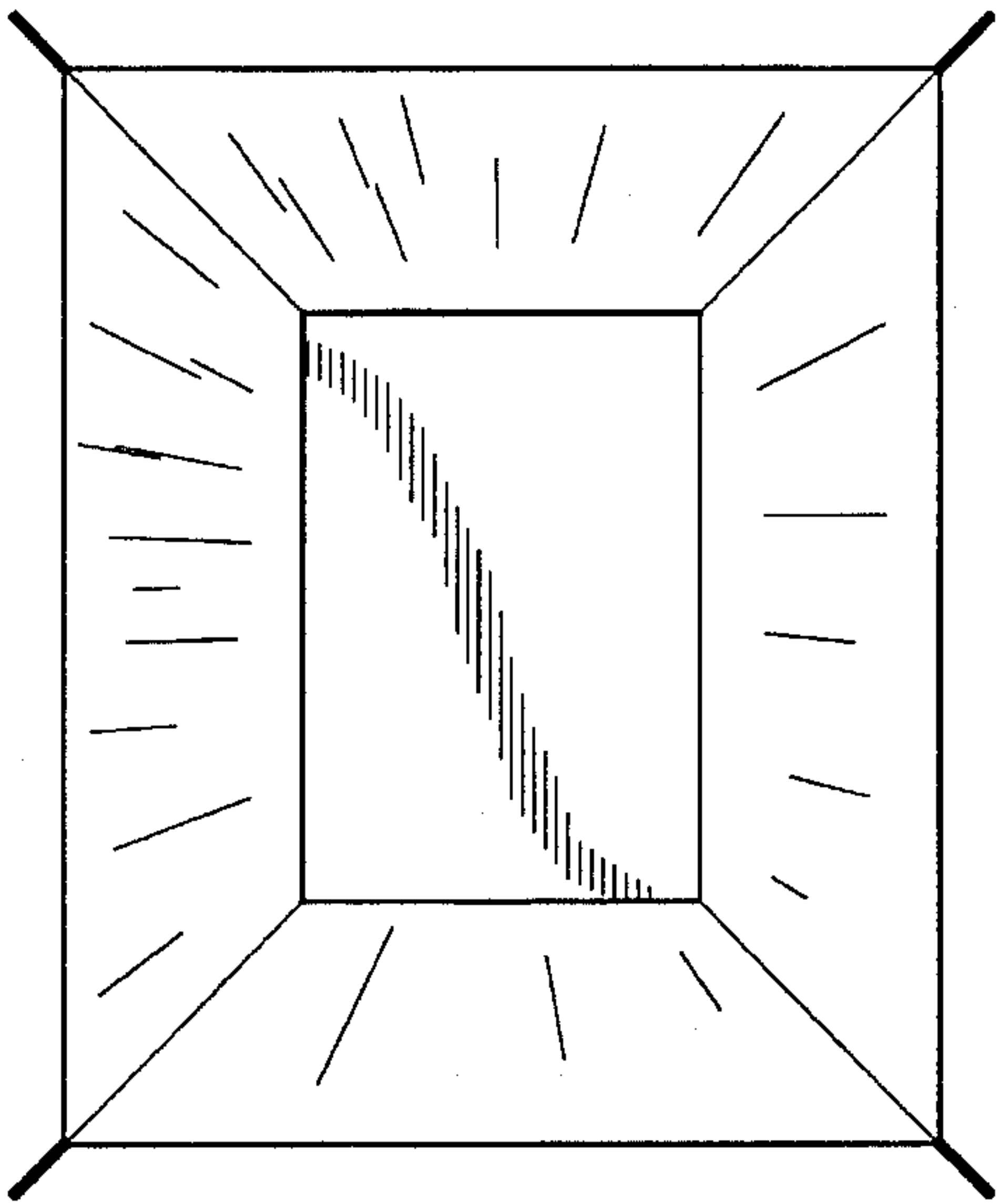

FIG. 58

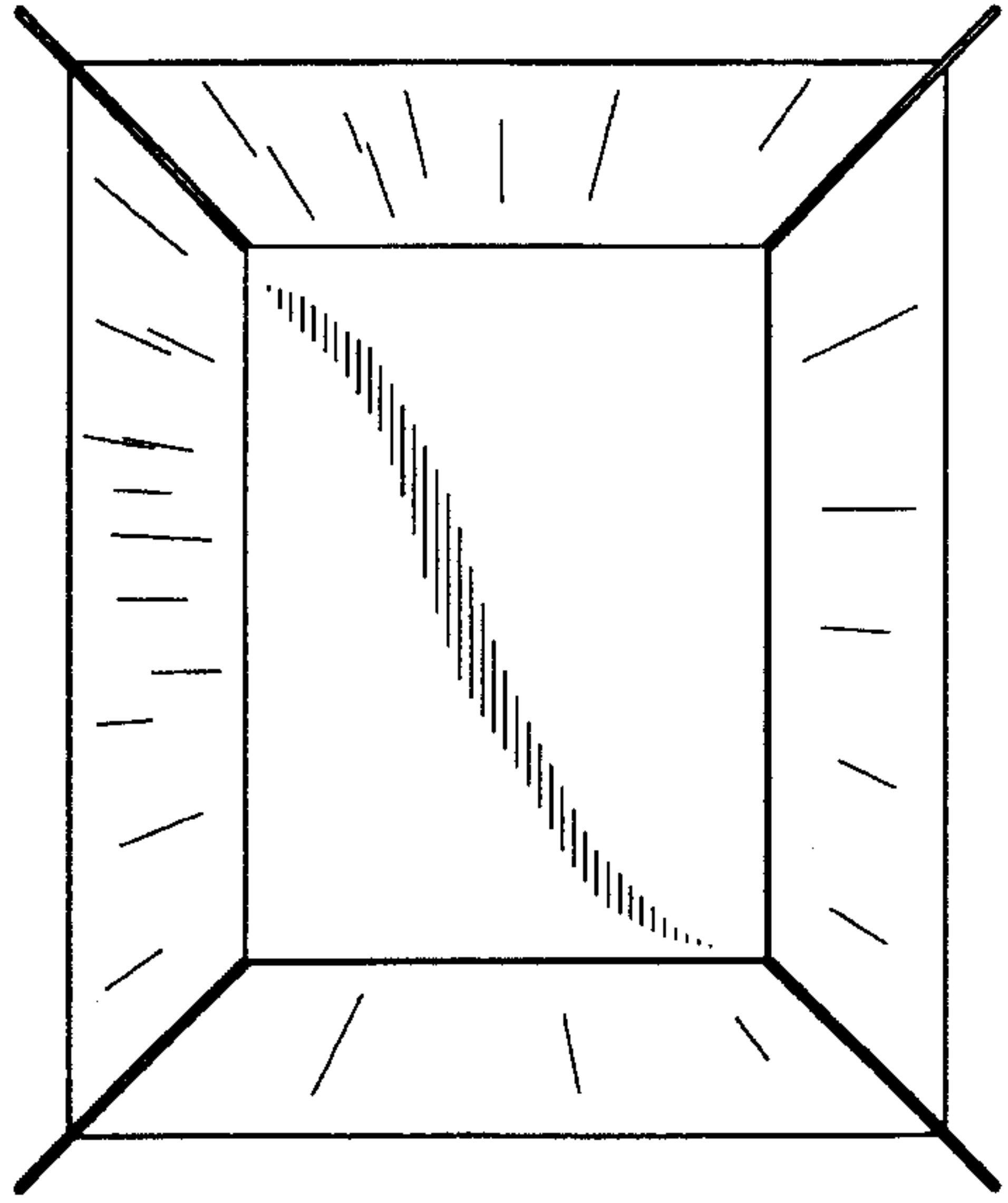

FIG. 59

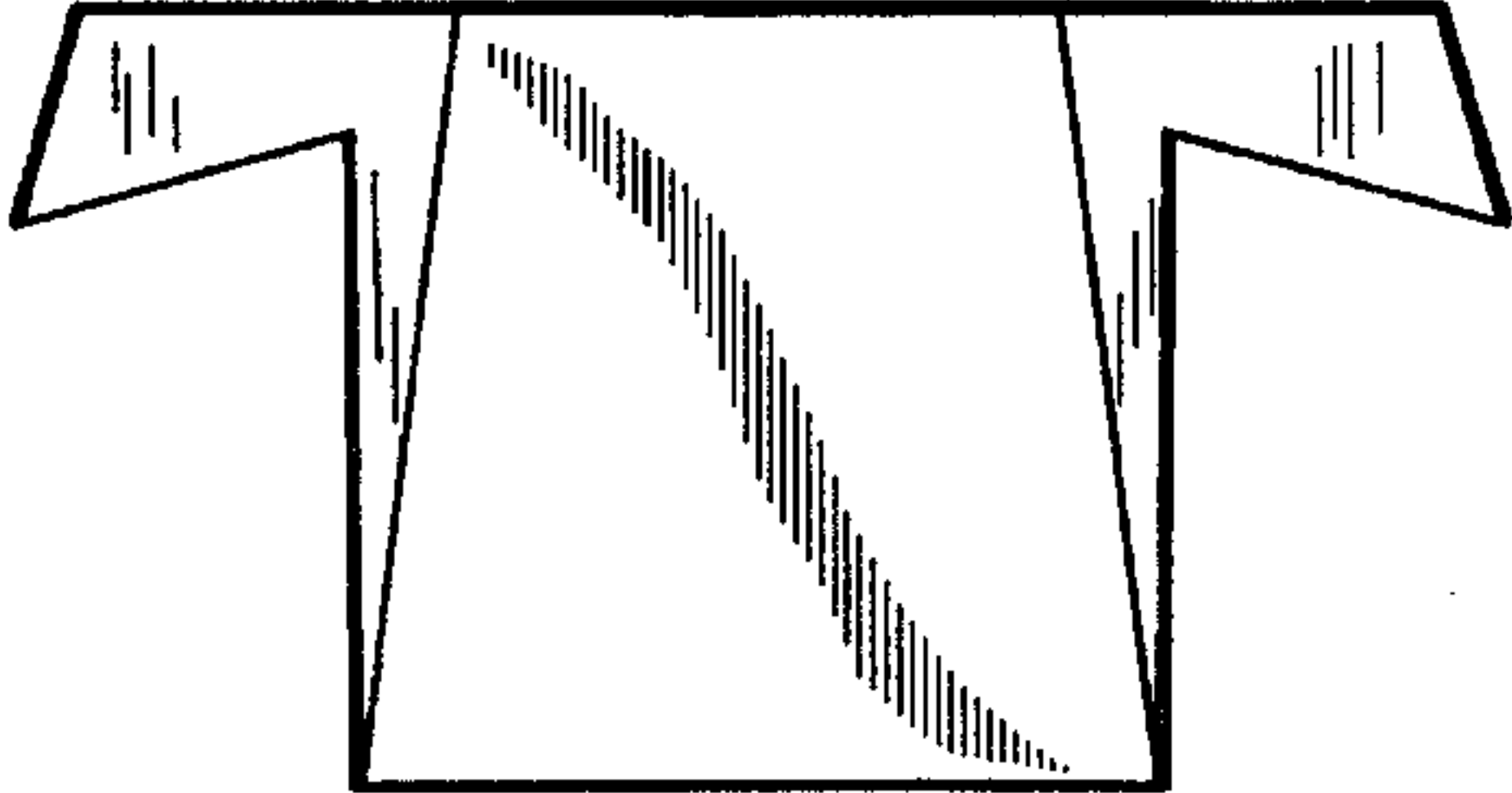

FIG. 60

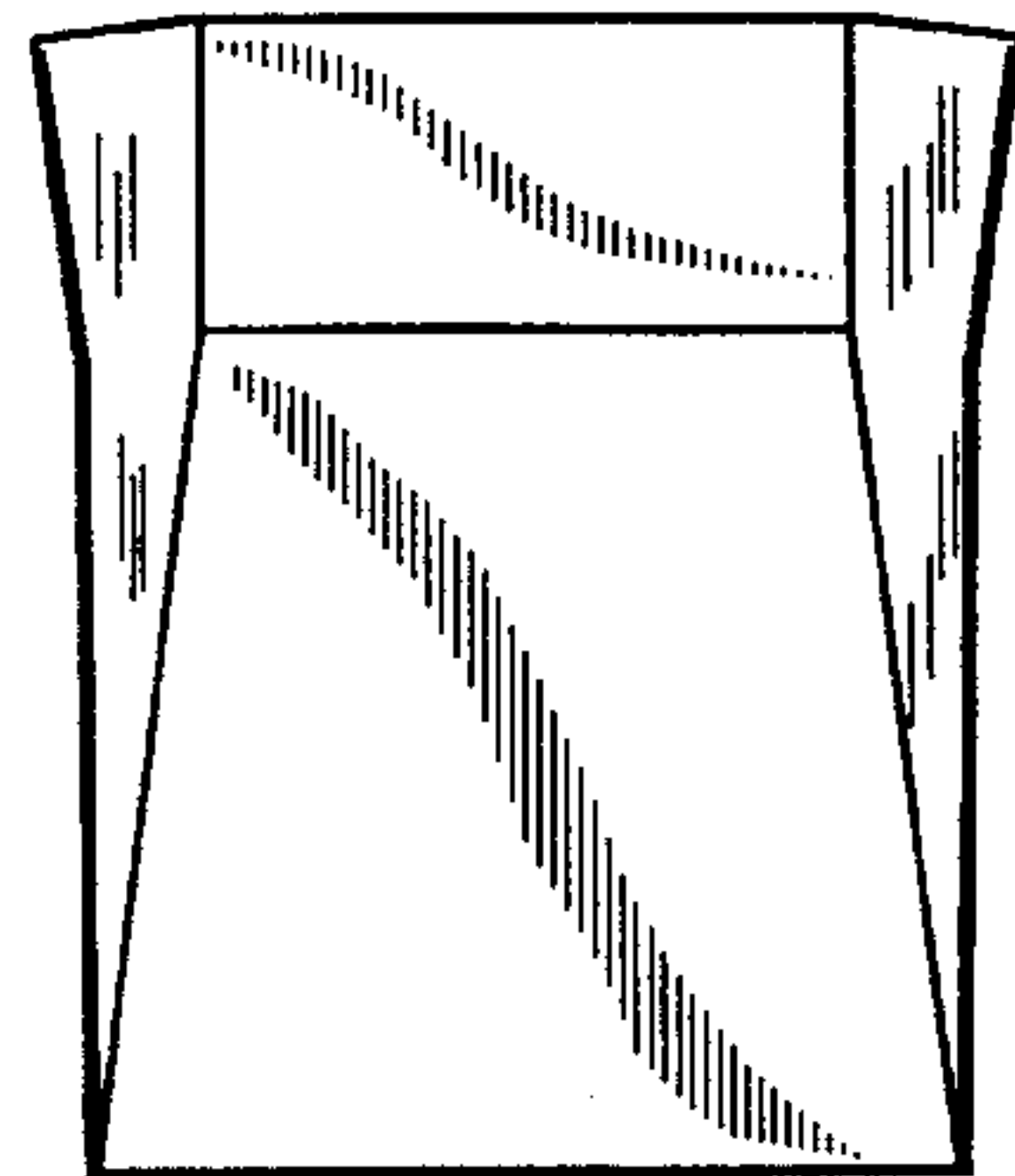

FIG. 61

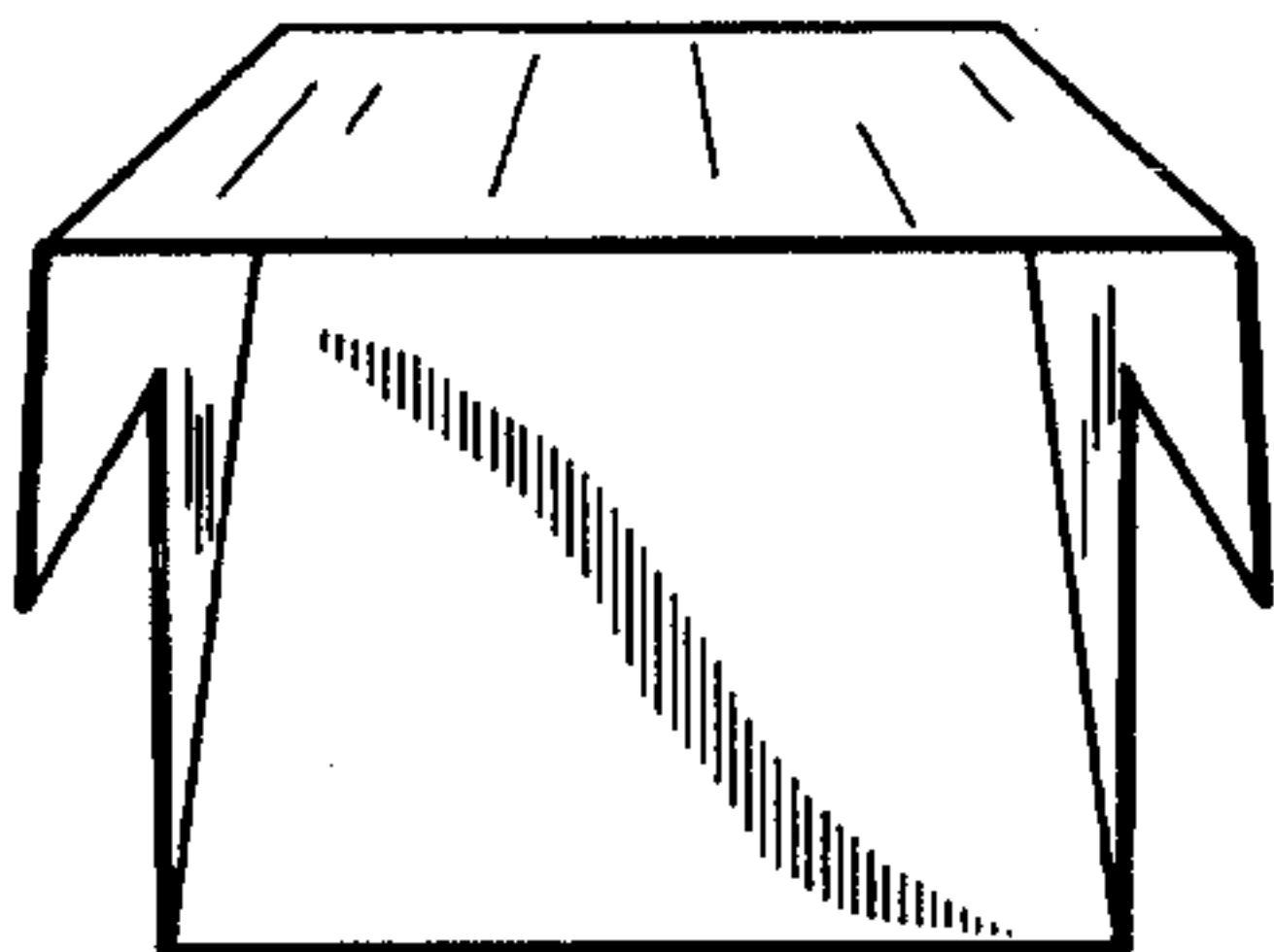

FIG. 62

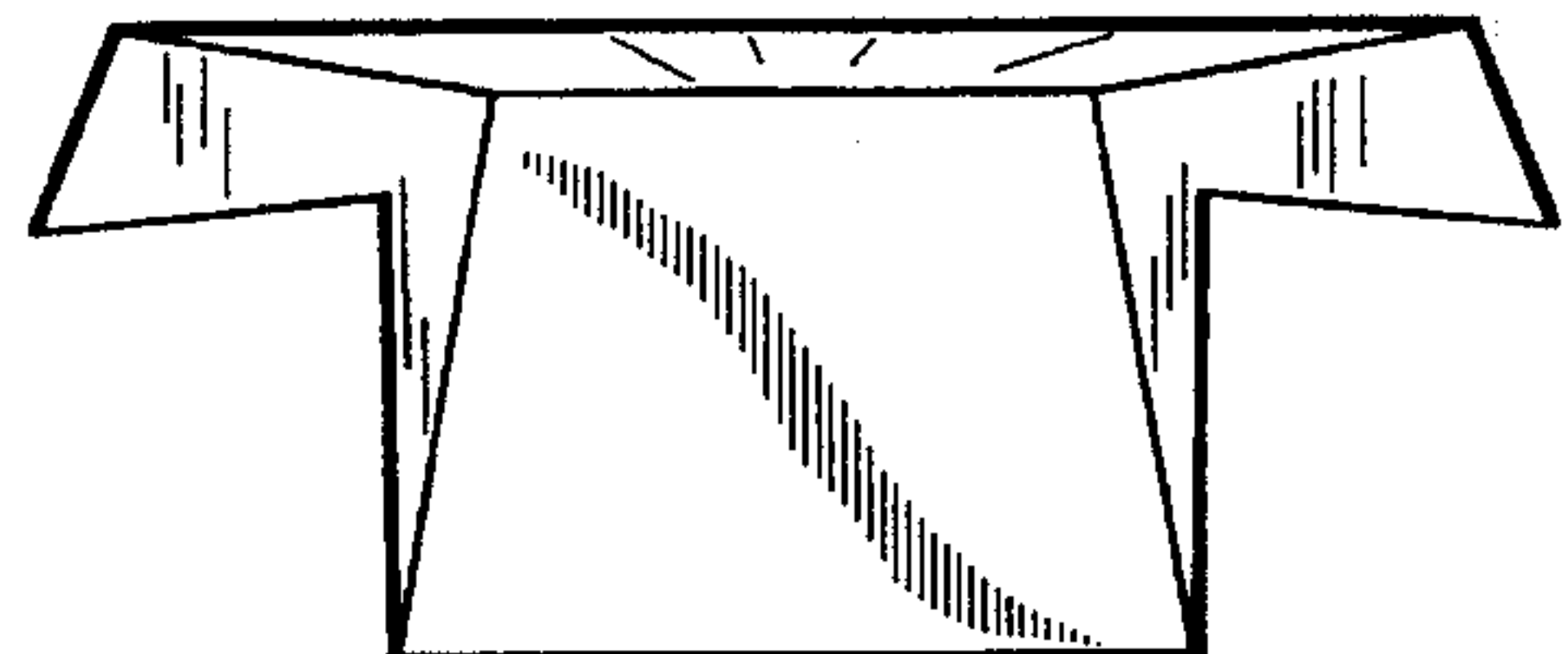

FIG. 63

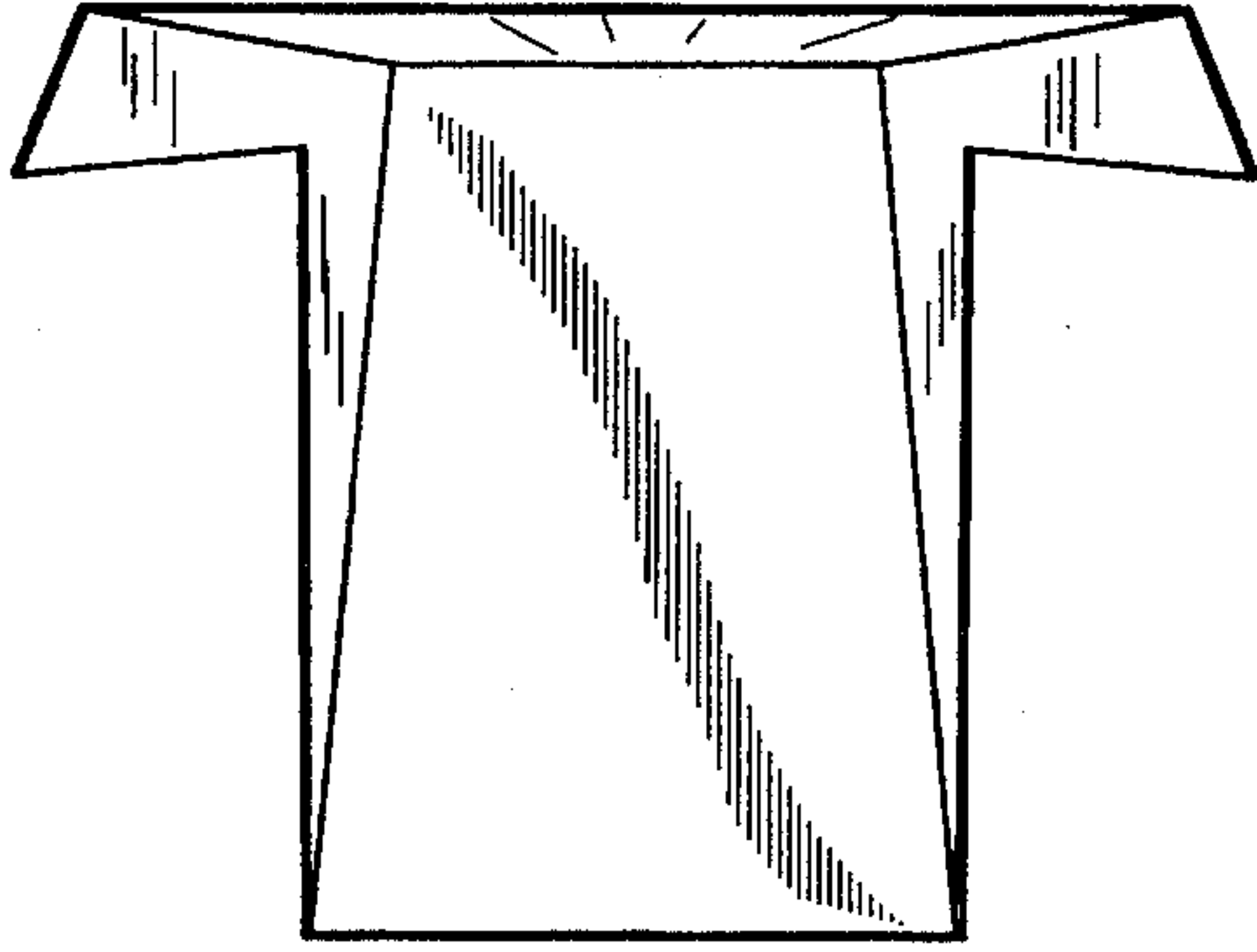

FIG. 54

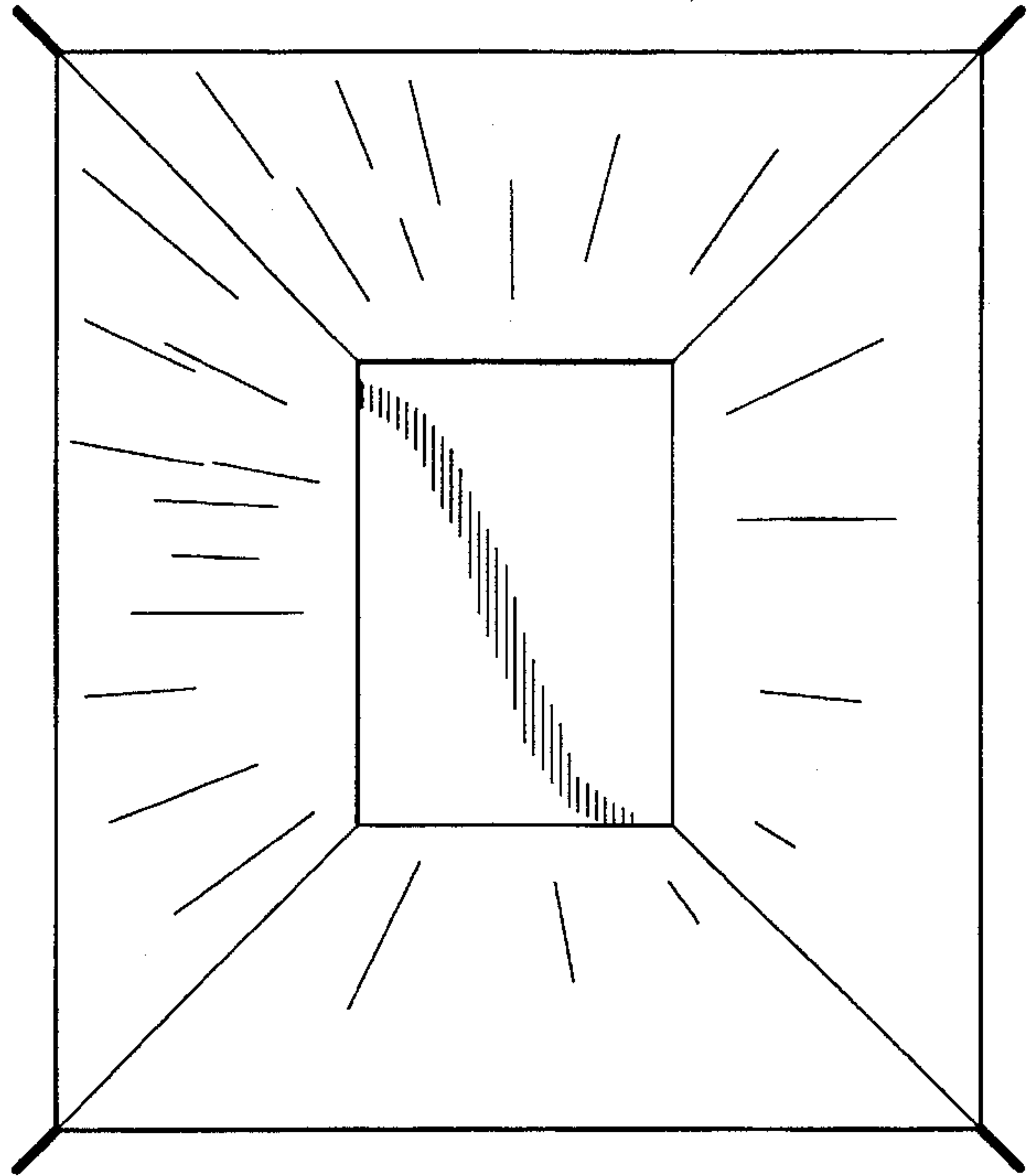

FIG. 55

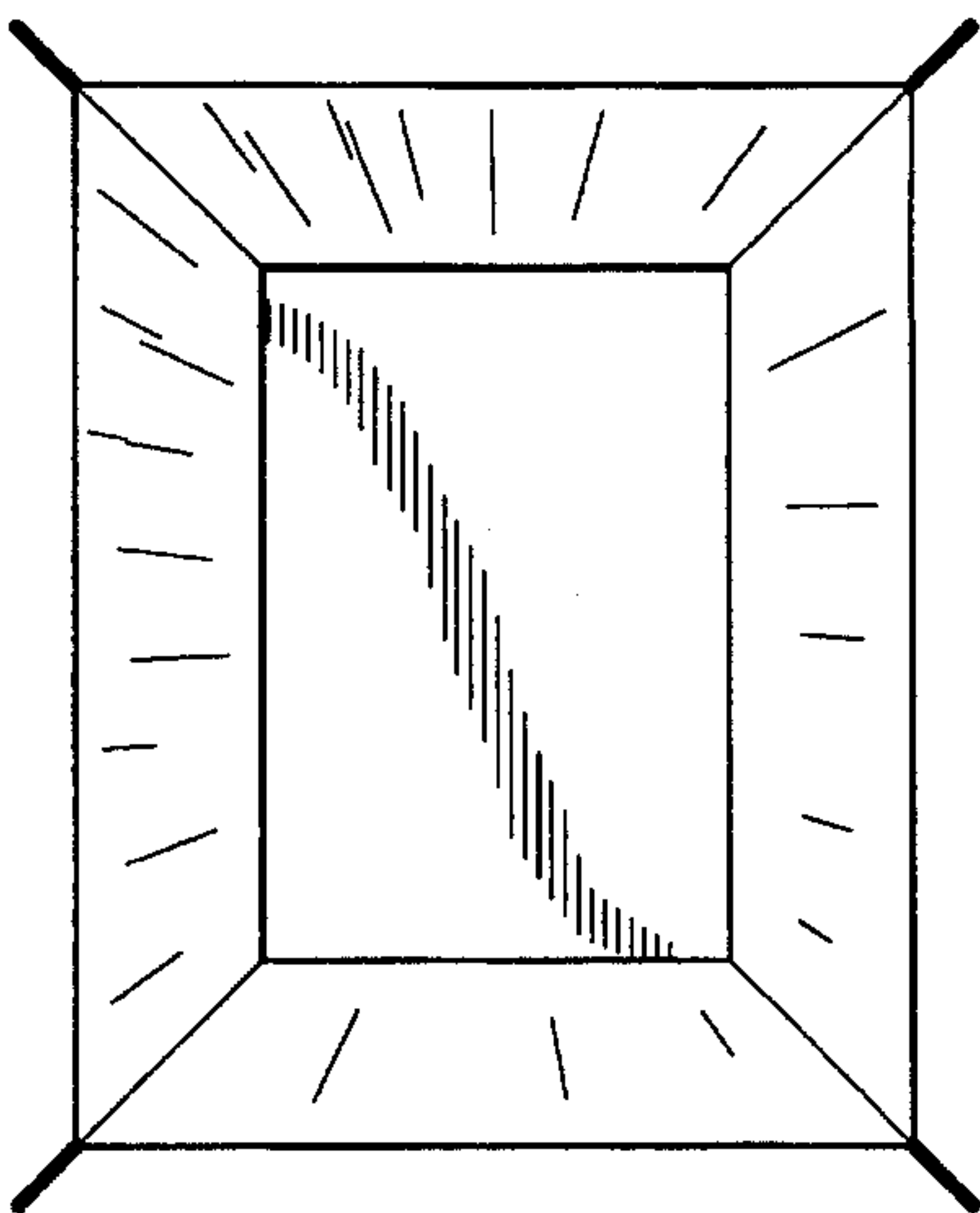

FIG. 56