



US00D364087S

United States Patent [19] Farley

[11] Patent Number: **Des. 364,087**

[45] Date of Patent: ****Nov. 14, 1995**

- [54] **CORRUGATED CARTON**
- [75] Inventor: **Timothy R. Farley**, Henderson, Ky.
- [73] Assignee: **The Servants, Inc.**, Jasper, Ind.
- [**] Term: **14 Years**
- [21] Appl. No.: **29,229**
- [22] Filed: **Sep. 30, 1994**
- [52] U.S. Cl. **D9/418; D9/432**
- [58] Field of Search **D9/416, 418, 432, D9/415, 433, 346, 337; 229/117.13, 149, 939, 117.14, 141**

- 4,327,829 5/1982 Hughes .
- 4,538,759 9/1985 Dutcher 229/117.13
- 4,969,596 10/1990 Schulbaum 229/149 X
- 5,065,937 11/1991 Ritter .

OTHER PUBLICATIONS

Packaging Catalog, 1959, p. 63, Item #46.

Primary Examiner—Prabhakar G. Deshmukh
Attorney, Agent, or Firm—Middleton & Reutlinger; David W. Carrithers

[57] CLAIM

The ornamental design for a corrugated carton, as shown and described.

DESCRIPTION

FIG. 1 is a front elevational perspective view of my design for a corrugated carton;
FIG. 2 is a top plan view thereof;
FIG. 3 is a rear end elevational view thereof;
FIG. 4 is a left side view thereof;
FIG. 5 is a front end elevational view thereof;
FIG. 6 is a bottom plan view; and,
FIG. 7 is a right side view.

[56] References Cited

U.S. PATENT DOCUMENTS

- D. 320,557 10/1991 Schuster D9/418
- D. 350,480 9/1984 Sutherland D9/416
- 1,129,909 3/1915 Simoneaux 229/149 X
- 1,474,879 11/1923 Ayres .
- 2,019,307 10/1935 Hill et al. 229/117.13
- 3,019,960 2/1962 Vaughen-Parks .
- 3,255,950 6/1966 Marcouly .
- 3,940,055 2/1976 Rowley .
- 4,314,639 2/1982 Gloyer 229/117.13 X

1 Claim, 1 Drawing Sheet

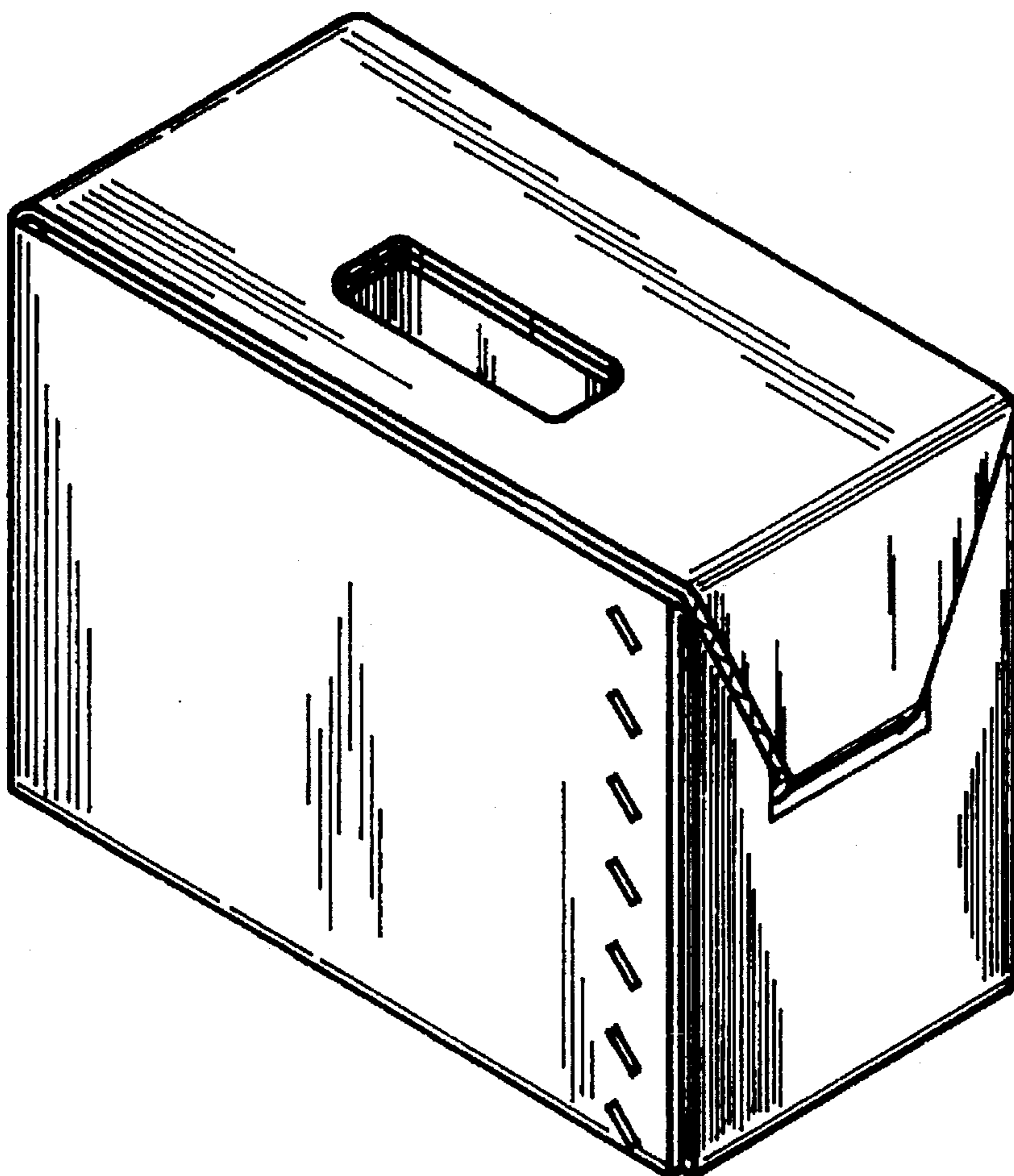

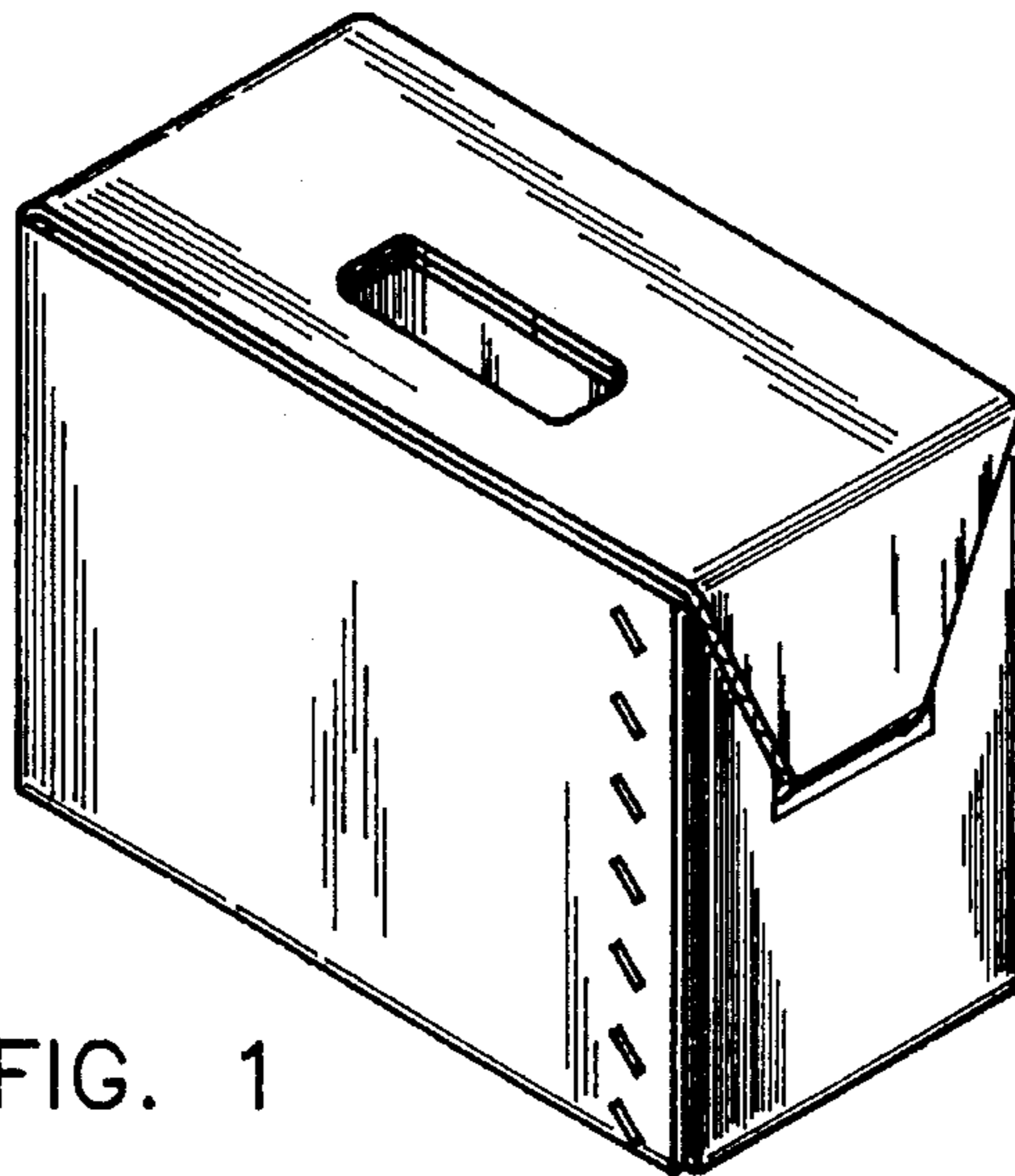

FIG. 1

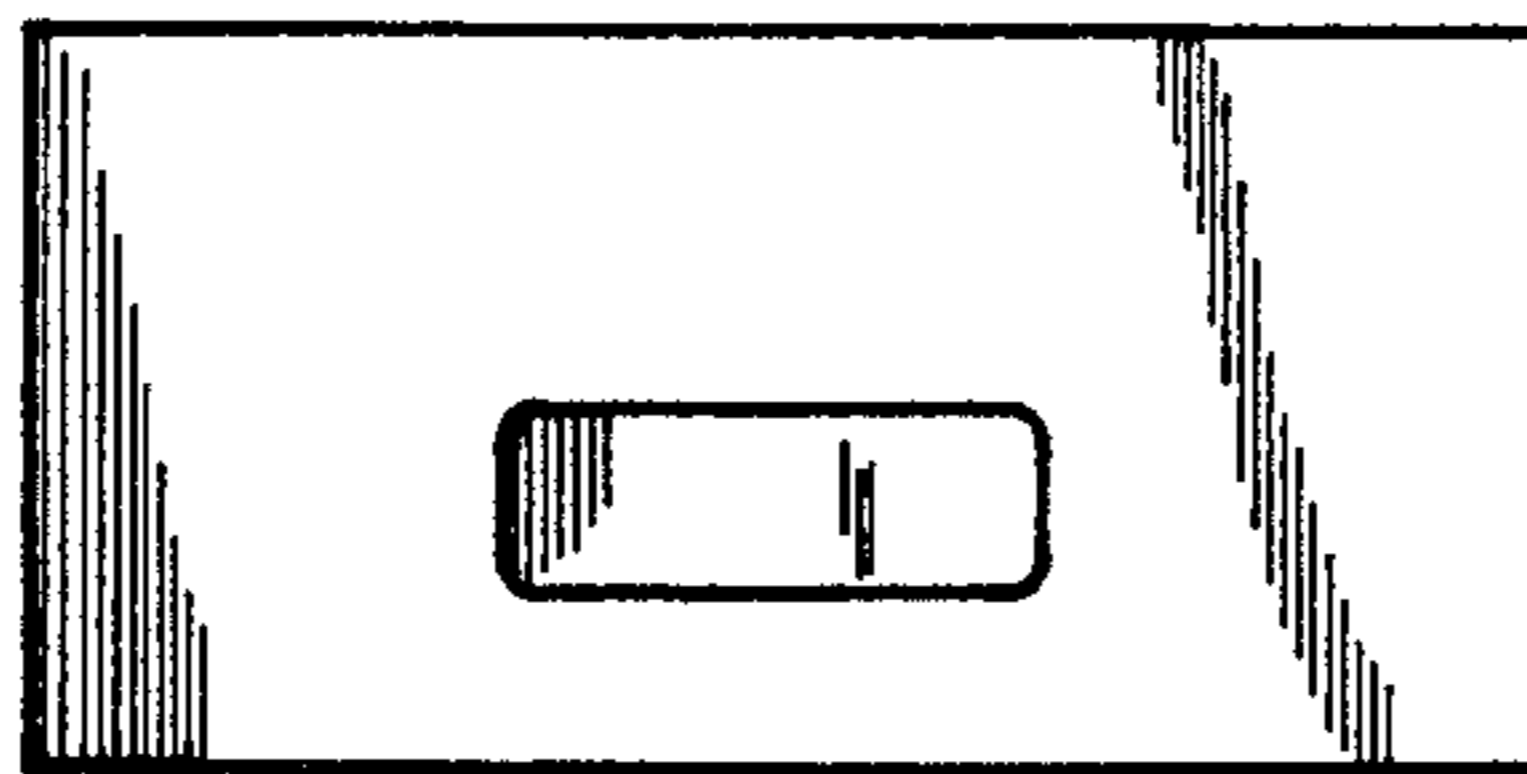

FIG. 2

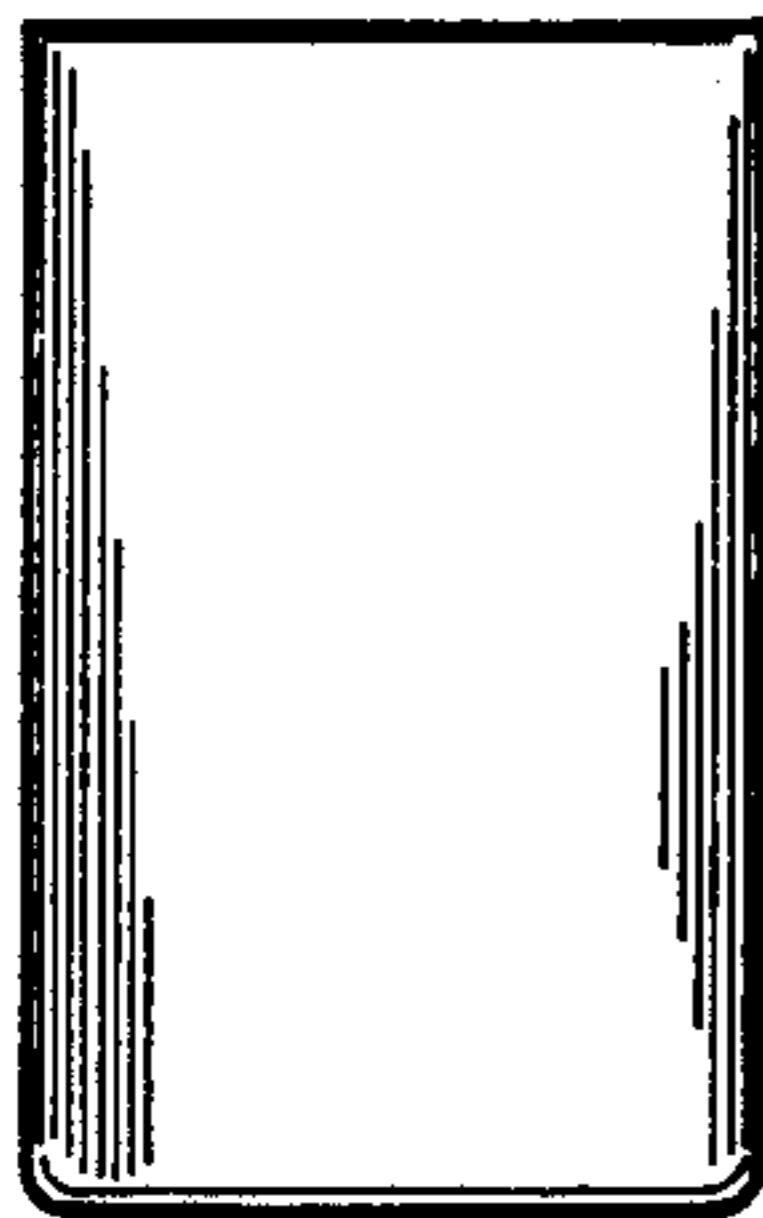

FIG. 3

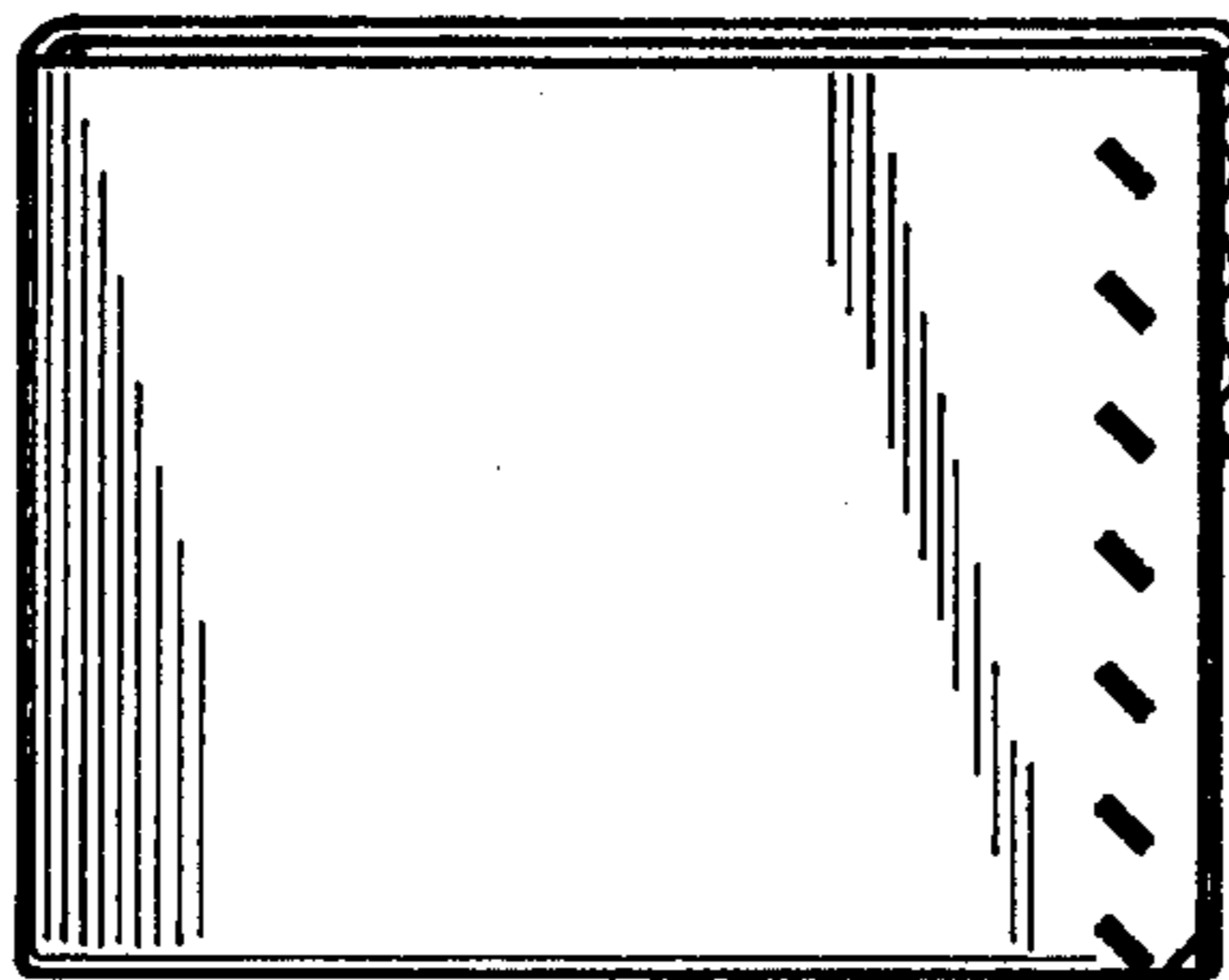

FIG. 4

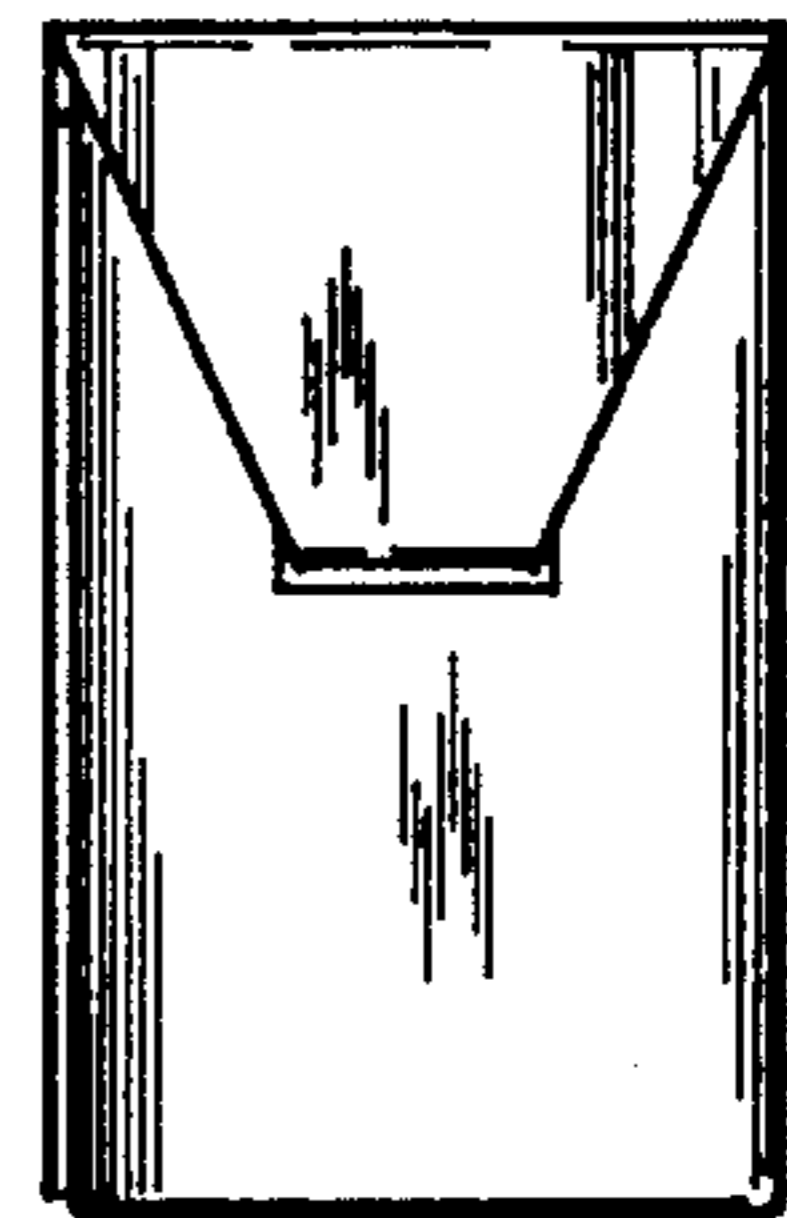

FIG. 5

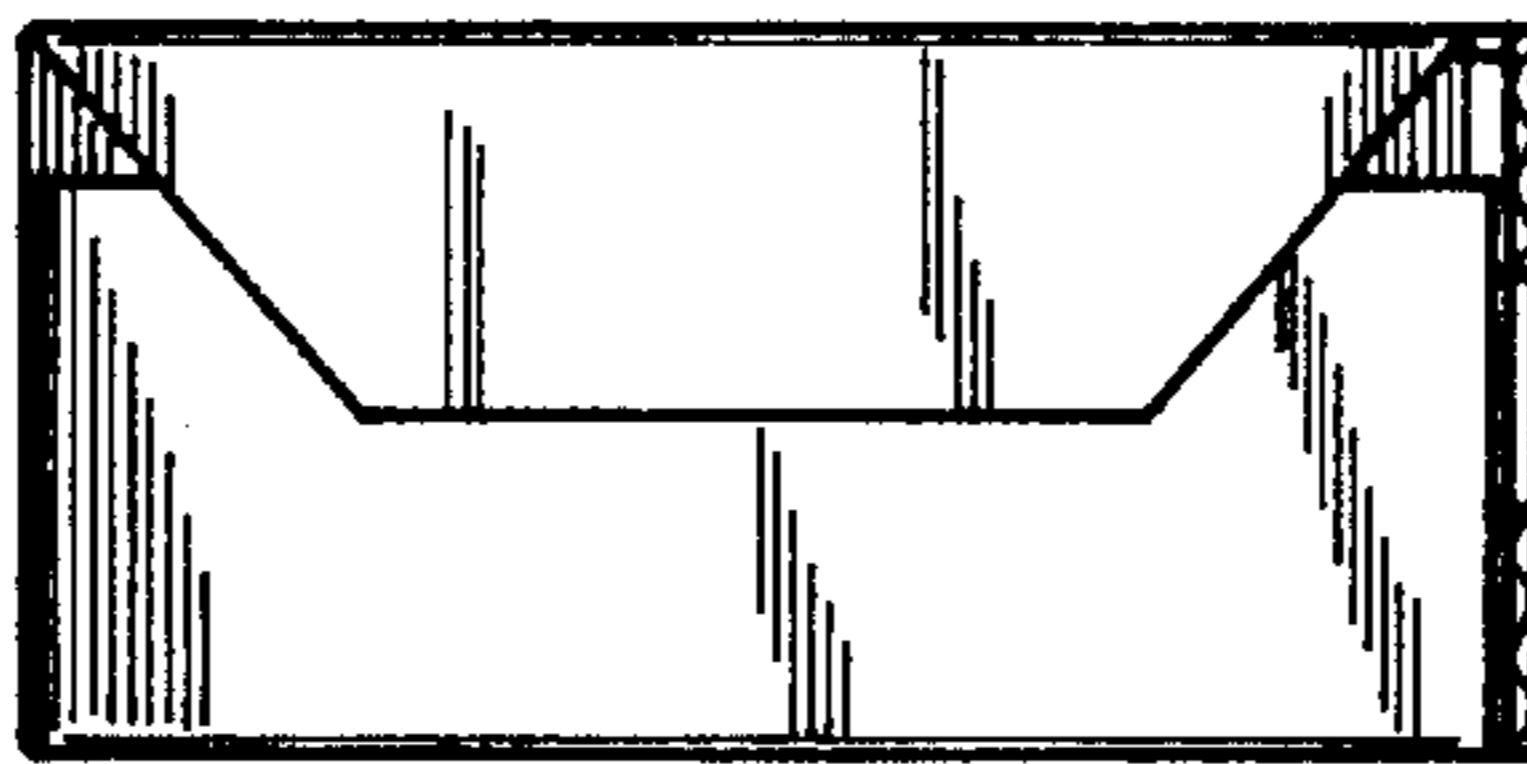

FIG. 6

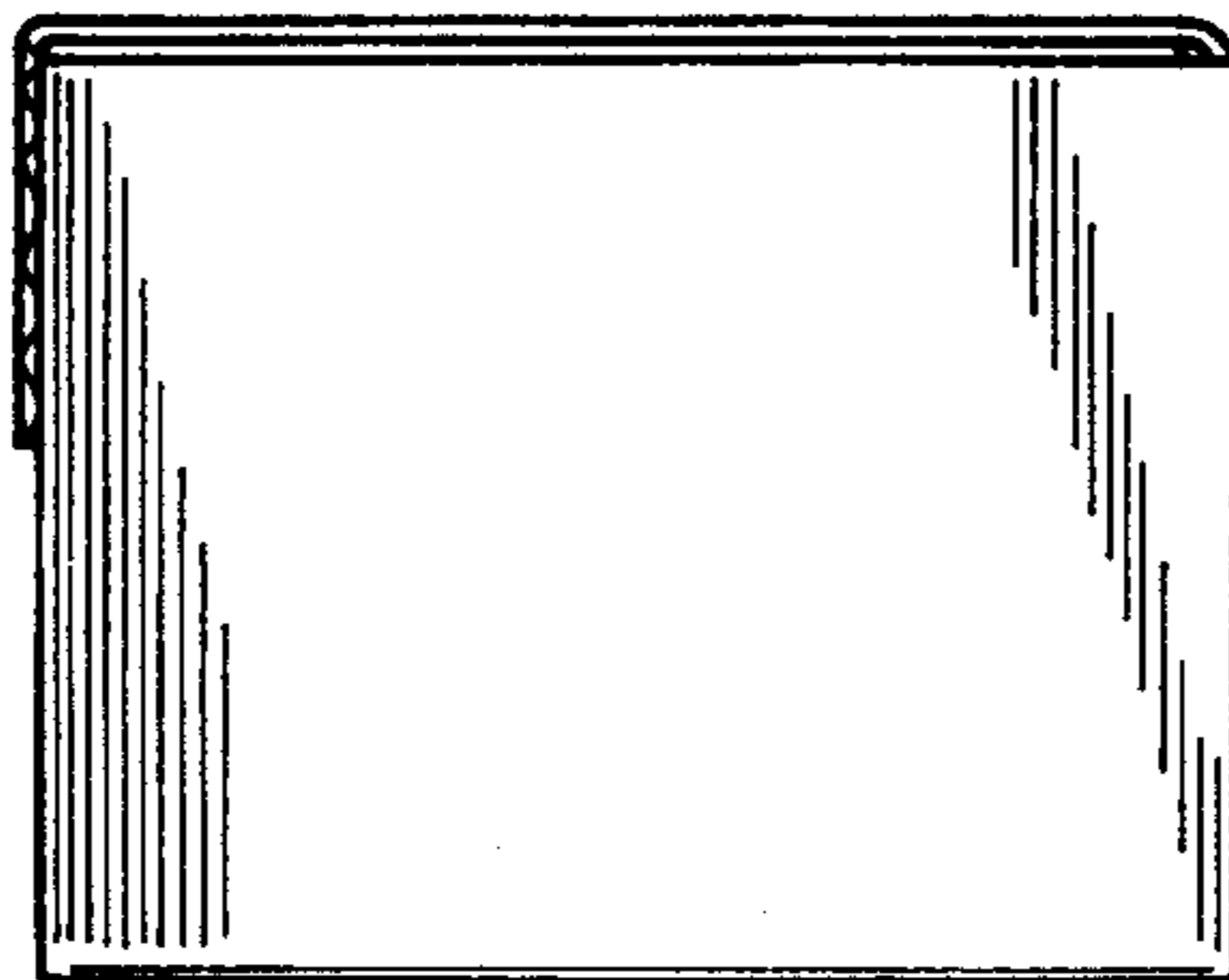

FIG. 7