



US00D364068S

United States Patent [19]

McCloskey et al.

[11] Patent Number: **Des. 364,068**

[45] Date of Patent: ****Nov. 14, 1995**

[54] **COFFEEMAKER**

[75] Inventors: **Don R. McCloskey**, Troy, Ohio;
Anthony B. Rorke, Guilford, Conn.

[73] Assignee: **Black & Decker Inc.**, Newark, Del.

[**] Term: **14 Years**

[21] Appl. No.: **32,196**

[22] Filed: **Dec. 14, 1994**

[52] U.S. Cl. **D7/309; D7/311**

[58] Field of Search **D7/300, 309, 310,**
D7/311; 99/295, 293, 290

[56] **References Cited**

U.S. PATENT DOCUMENTS

D. 253,572	12/1979	Rinaldi	D7/309
D. 281,943	12/1985	Rosalgino	D7/309
D. 339,263	9/1993	McCloskey	D7/310
D. 339,953	10/1993	Bunn et al.	D7/307
D. 344,427	2/1994	Bannigan	D7/311 X

D. 355,560	2/1995	Assmann	D7/310 X
D. 356,712	3/1995	Brady	D7/309
D. 358,736	5/1995	Kahlcke	D7/310 X

Primary Examiner—Alan P. Douglas
Assistant Examiner—M. N. Pandozzi
Attorney, Agent, or Firm—Barry E. Deutsch

[57] **CLAIM**

The ornamental design for a coffeemaker, as shown and described.

DESCRIPTION

FIG. 1 is a perspective view, taken from the front, top and left side of a coffeemaker illustrating our new design; FIG. 2 is a top plan view thereof; FIG. 3 is a front elevational view thereof; FIG. 4 is a rear elevational view thereof; FIG. 5 is a bottom plan view thereof; FIG. 6 is a right side elevational view thereof; and, FIG. 7 is a left side elevational view thereof.

1 Claim, 4 Drawing Sheets

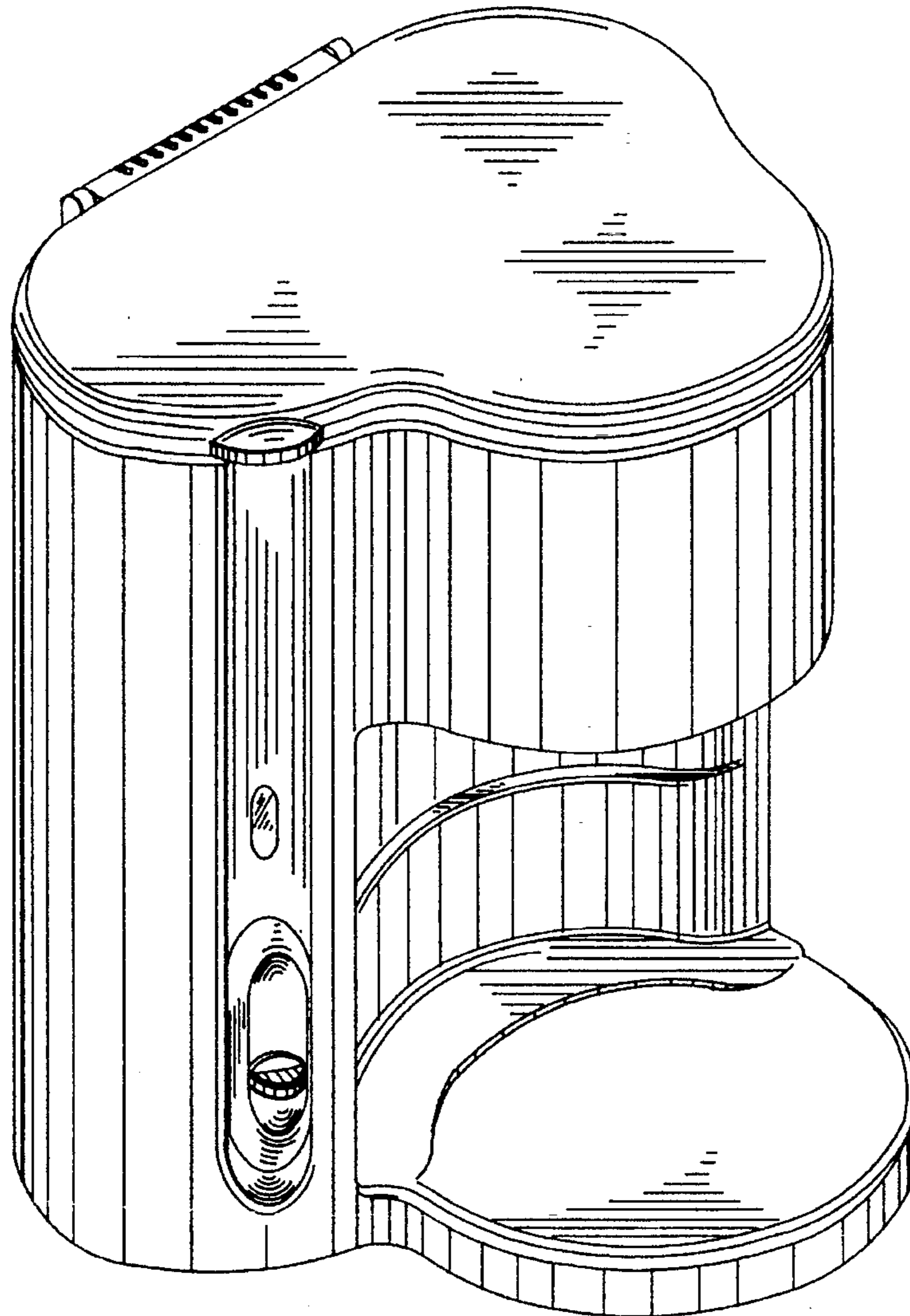

FIG. 1

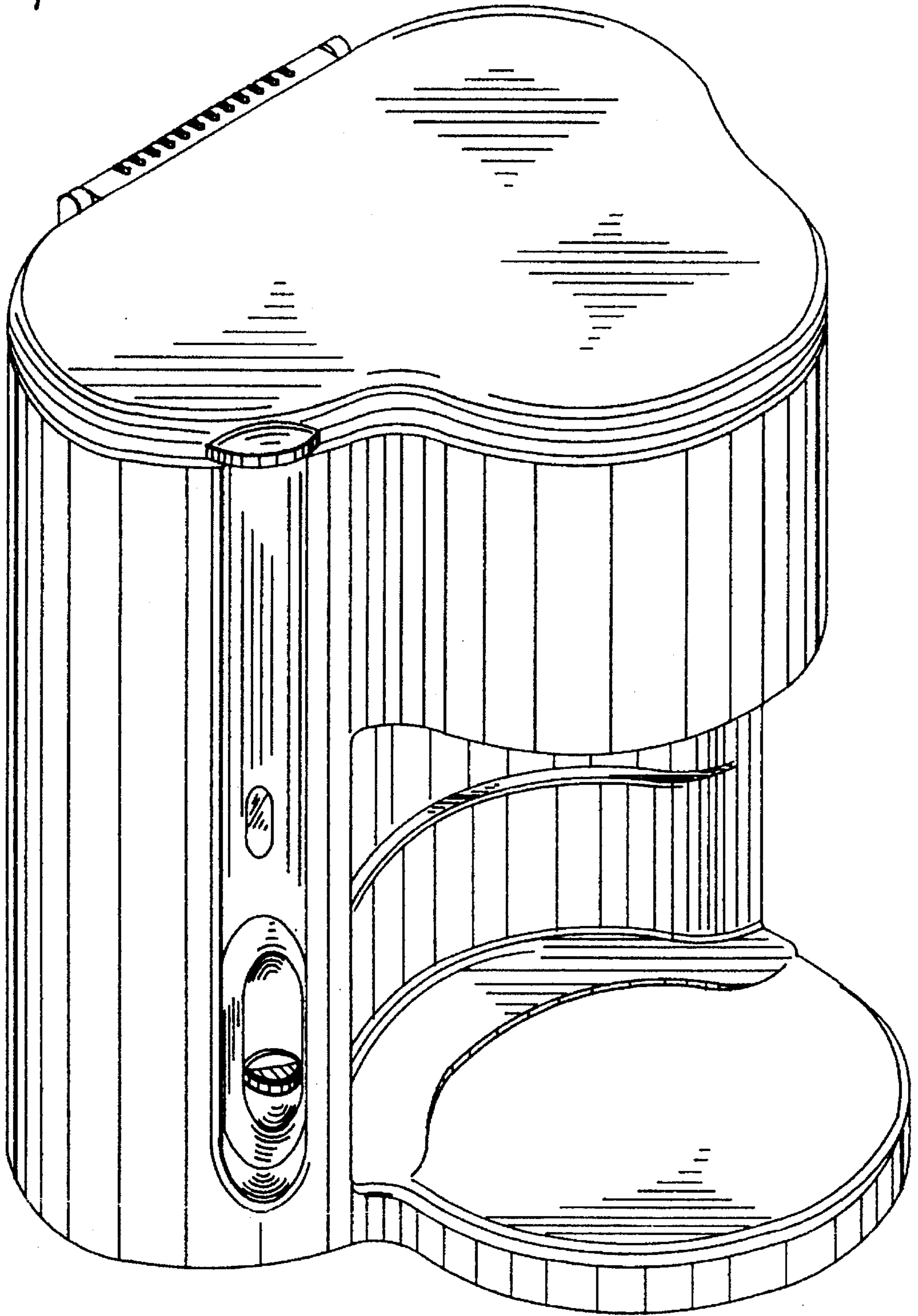

FIG. 2

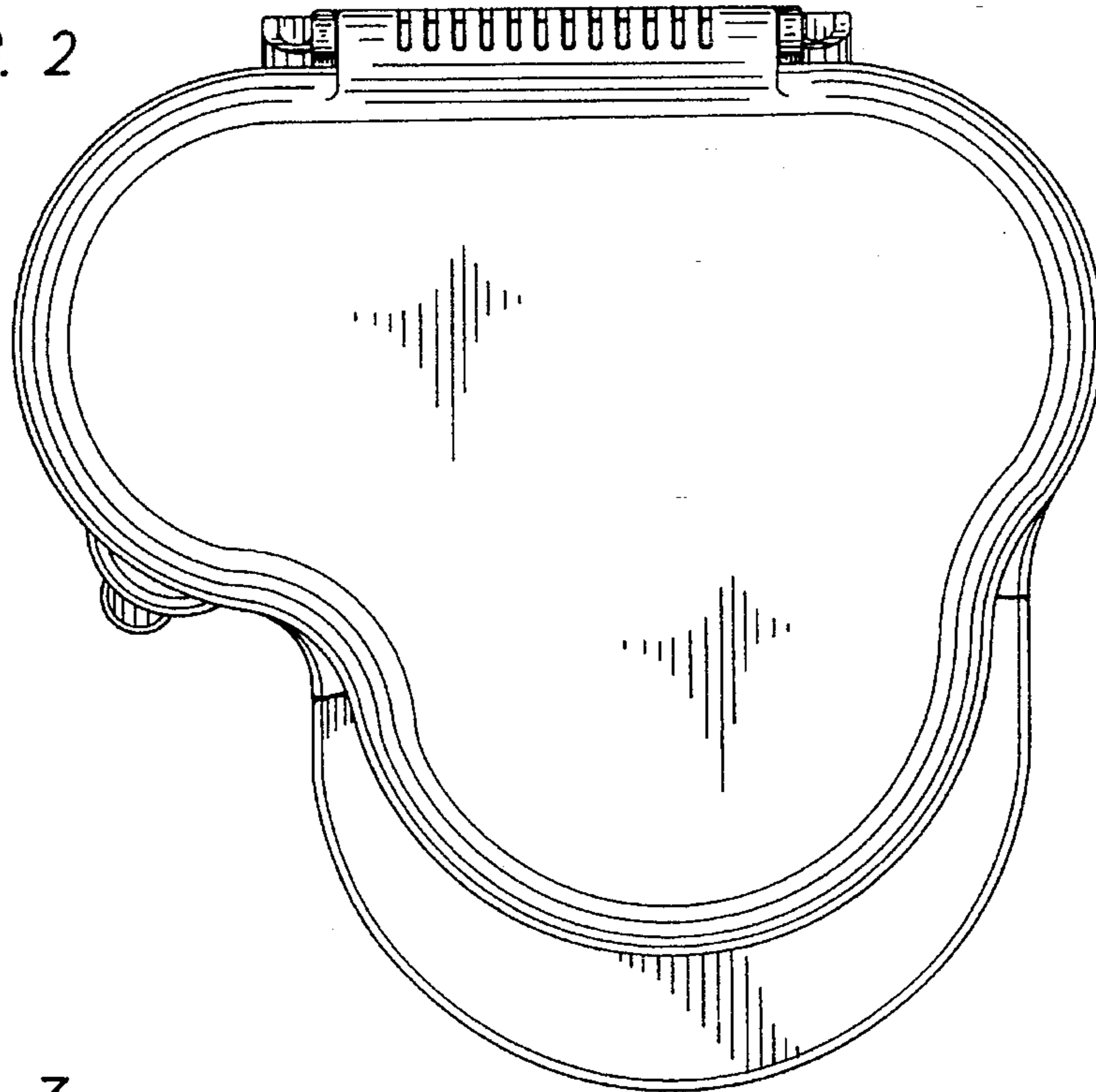

FIG. 3

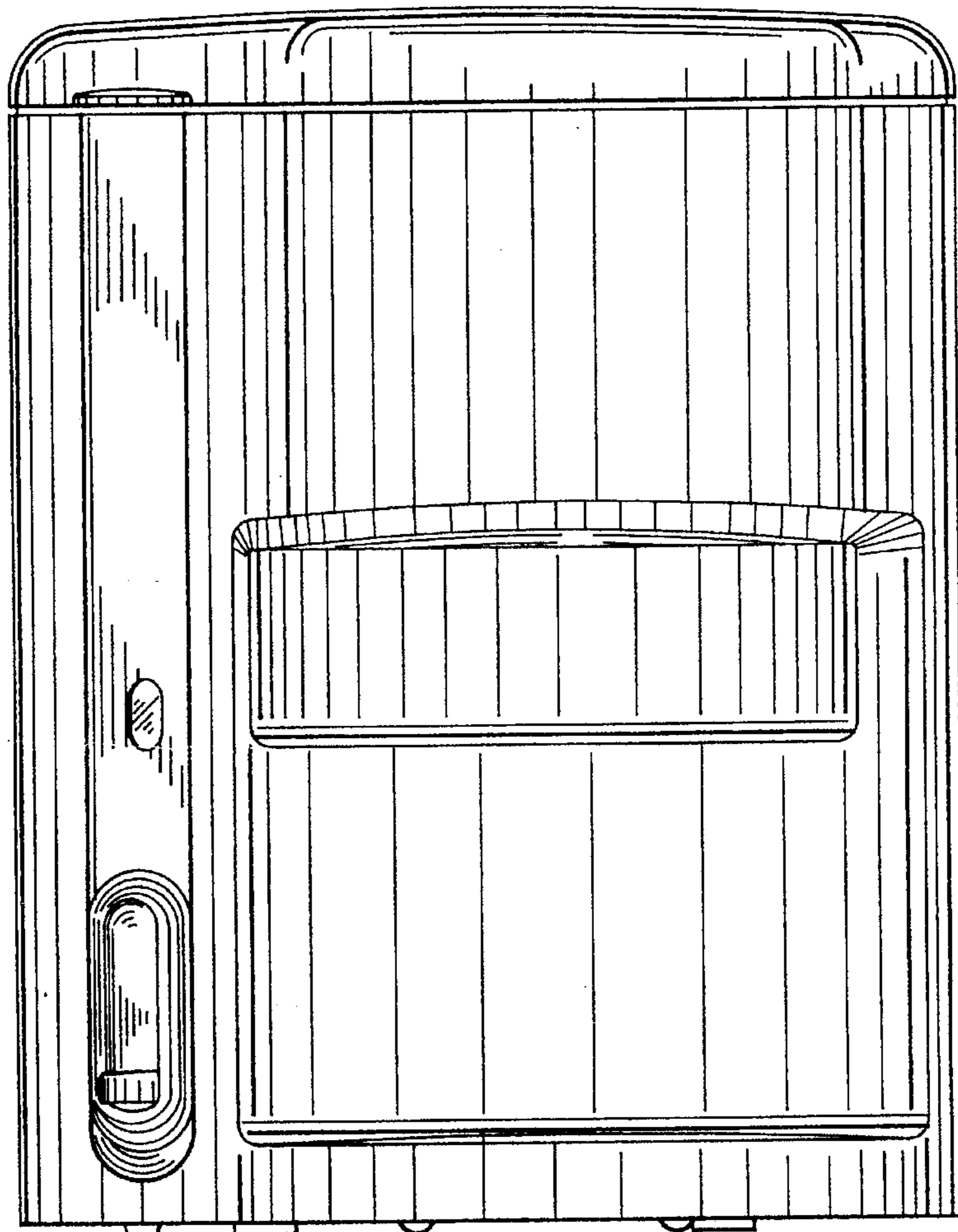

FIG. 4

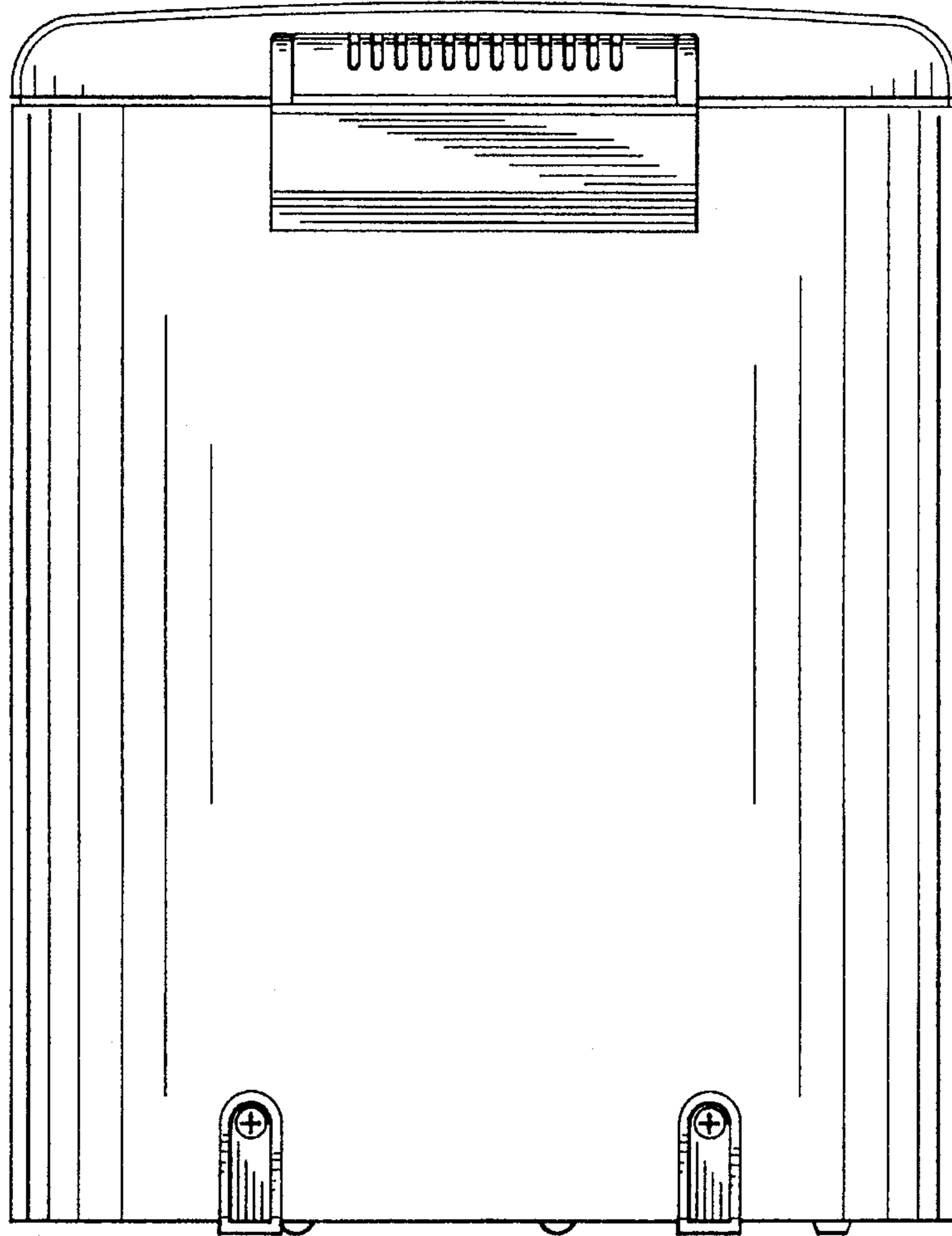

FIG. 5

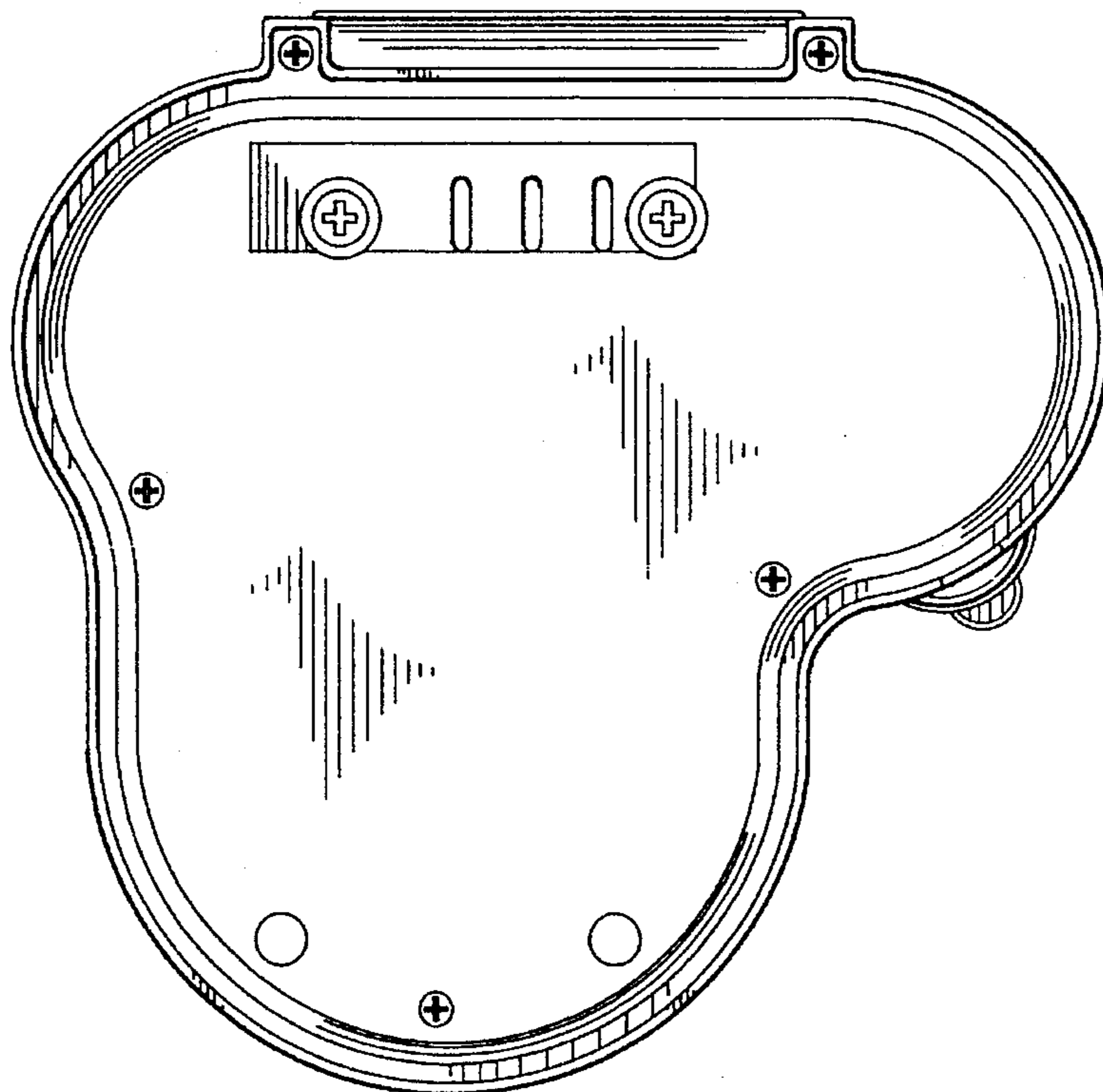

FIG. 7

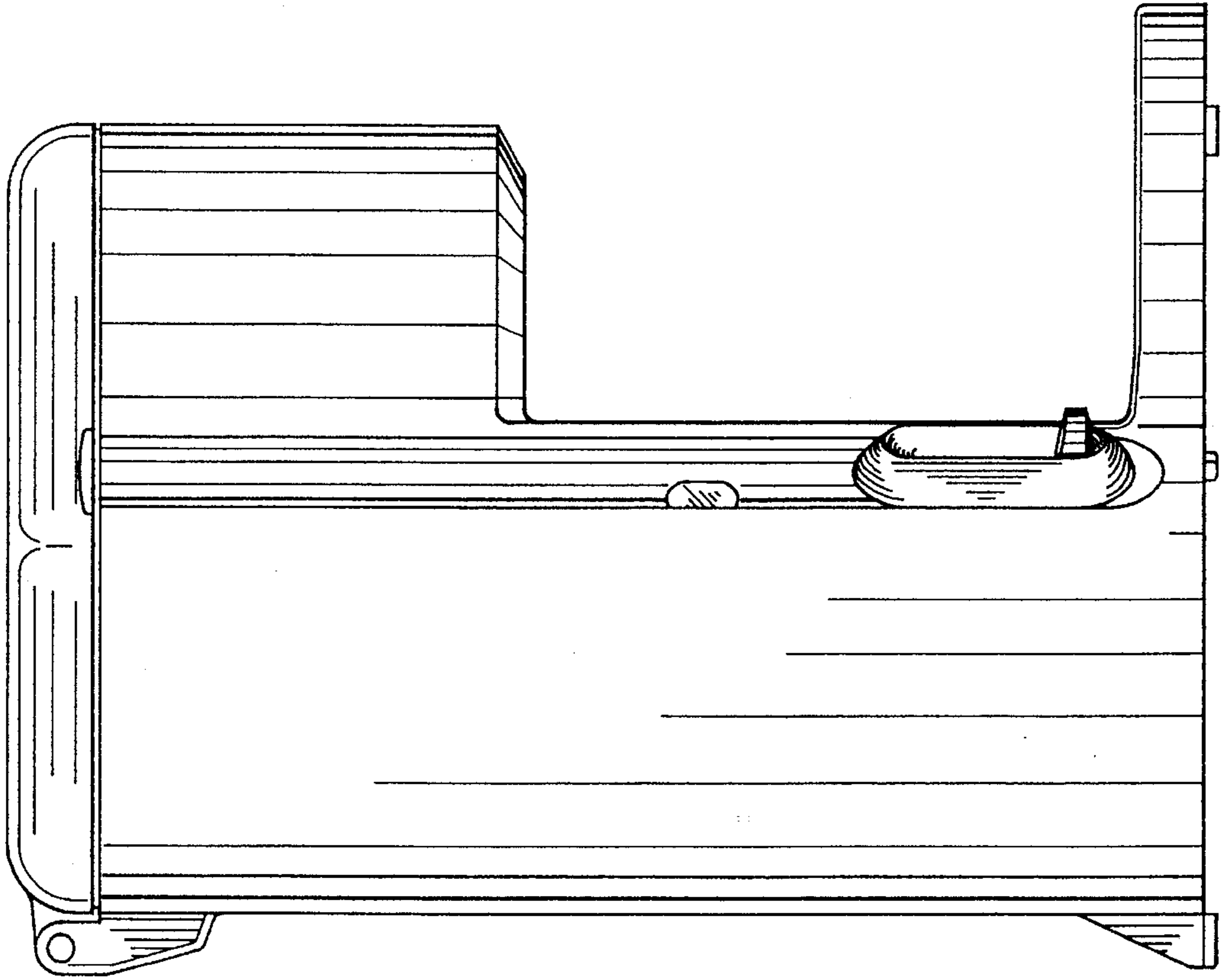

FIG. 6

