



US00D363953S

# United States Patent [19]

[11] **Patent Number: Des. 363,953**

**Buse**

[45] **Date of Patent: \*\*Nov. 7, 1995**

[54] **APERTURED BOARD FOR USE IN ASSOCIATION WITH A BEAN BAG TOSSING GAME**

2,050,914	8/1936	Anderson .....	273/401
4,938,485	7/1990	Hockridge et al. ....	273/401
4,943,065	7/1990	DeLapa .....	273/402
5,165,695	11/1992	Yoder .....	273/402

[76] Inventor: **James F. Buse**, 6057 Azalea St., Chino, Calif. 91710

*Primary Examiner*—Martie Thompson

[\*\*] Term: **14 Years**

### [57] CLAIM

[21] Appl. No.: **6,548**

The ornamental design for a apertured board for use in association with a bean bag tossing game, as shown and described.

[22] Filed: **Mar. 31, 1993**

### DESCRIPTION

[52] U.S. Cl. .... **D21/5**

[58] **Field of Search** ..... D19/99, 100; D21/5, D21/1; 273/400, 401, 402, 407, 415, 317, 398, 425

FIG. 1 is a front elevational view of the apertured board for use in association with a bean bag tossing game showing my new design;

FIG. 2 is a rear elevational view thereof;

FIG. 3 is a left side elevational view thereof;

FIG. 4 is a right side elevational view thereof;

FIG. 5 is a top plan view thereof;

FIG. 6 is a bottom plan view thereof; and,

FIG. 7 is an isometric view thereof.

### [56] References Cited

#### U.S. PATENT DOCUMENTS

D. 33,353	10/1900	Lazare .....	D21/5
D. 49,127	5/1916	McIntyre .....	D21/5 X
D. 118,939	2/1940	Hawkins et al. ....	D21/5
D. 224,242	7/1972	Waddle et al. ....	D21/5
D. 353,671	12/1994	Goldman .....	D24/30

**1 Claim, 4 Drawing Sheets**

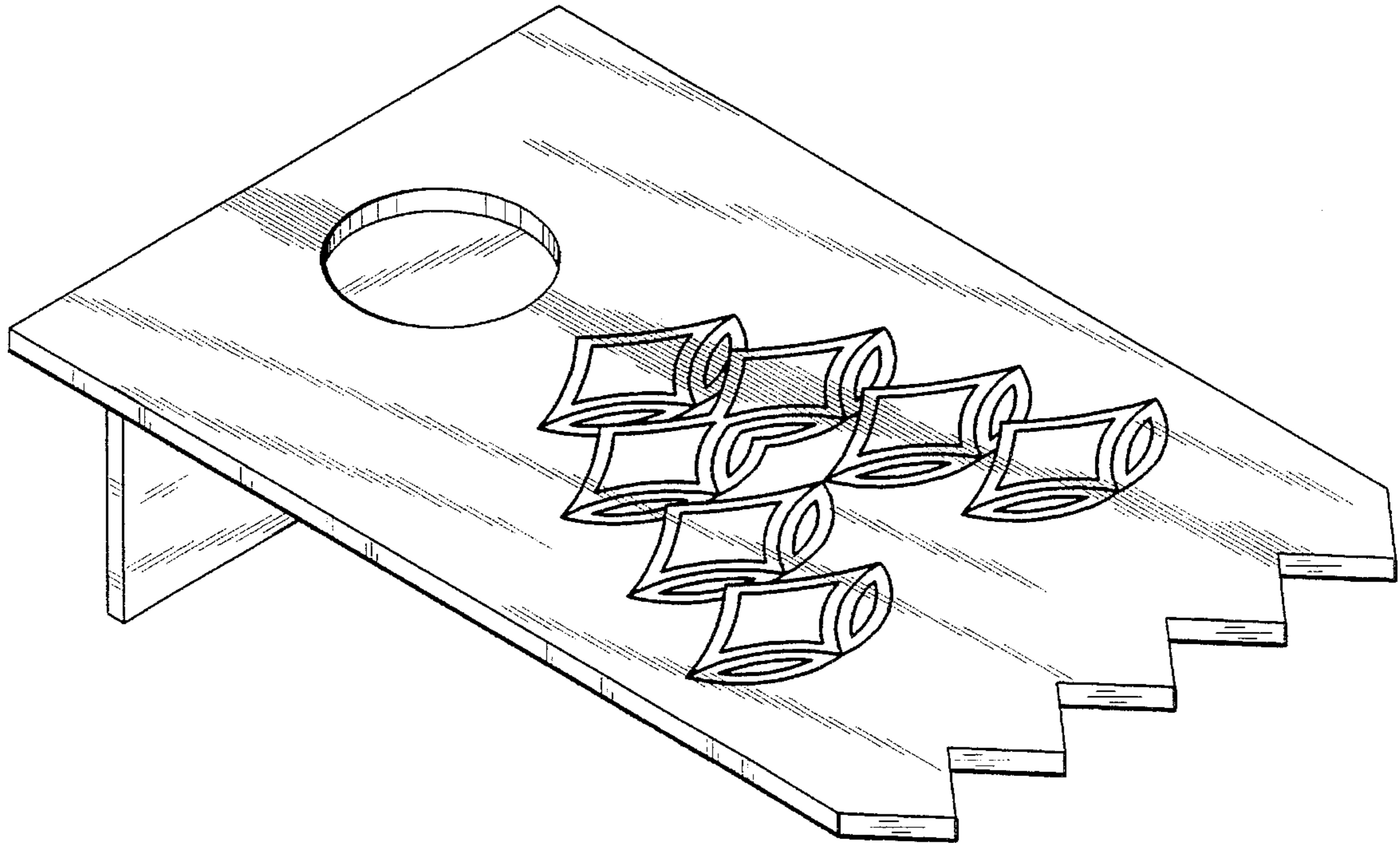

FIG. 1

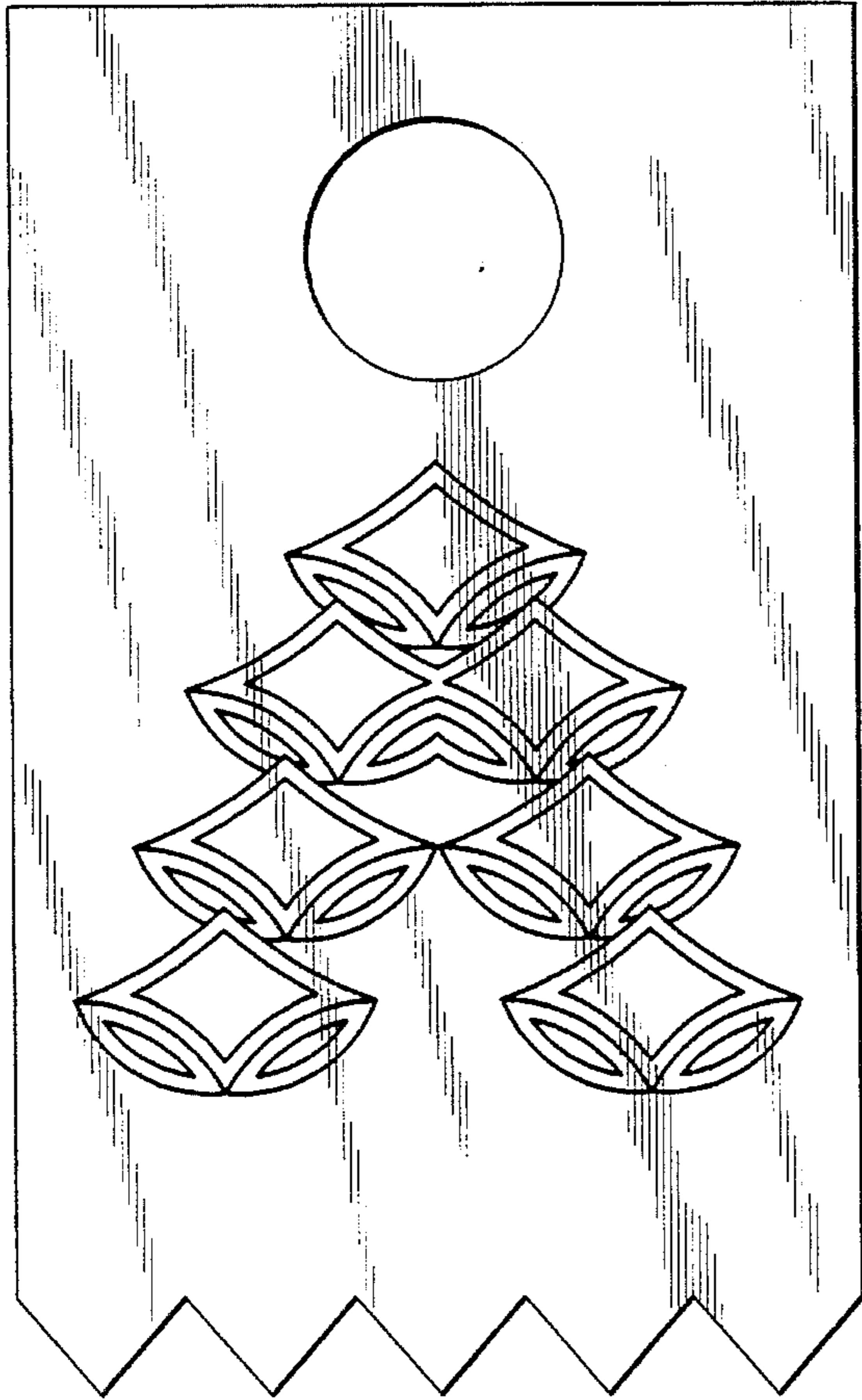

FIG. 2

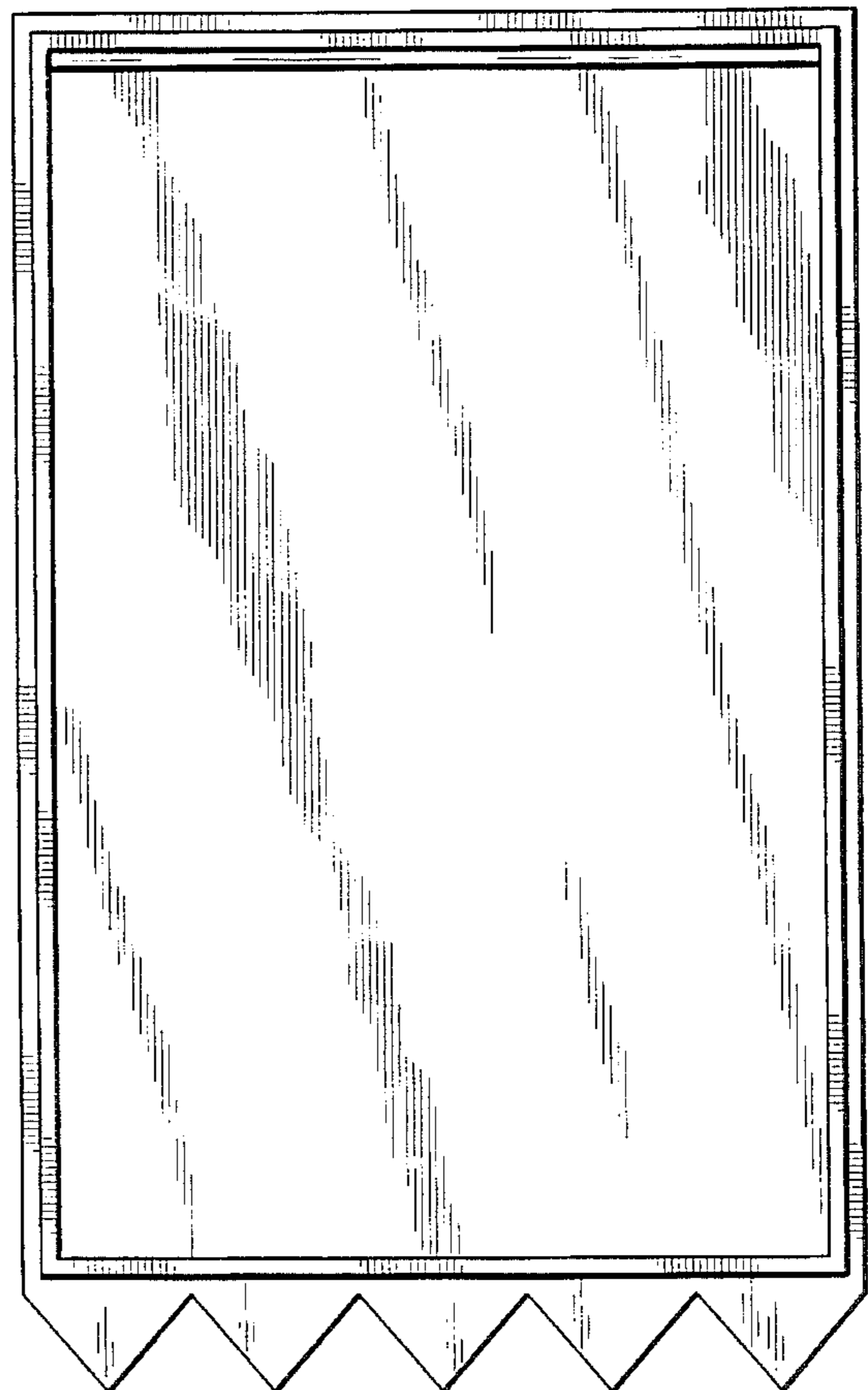

FIG. 3

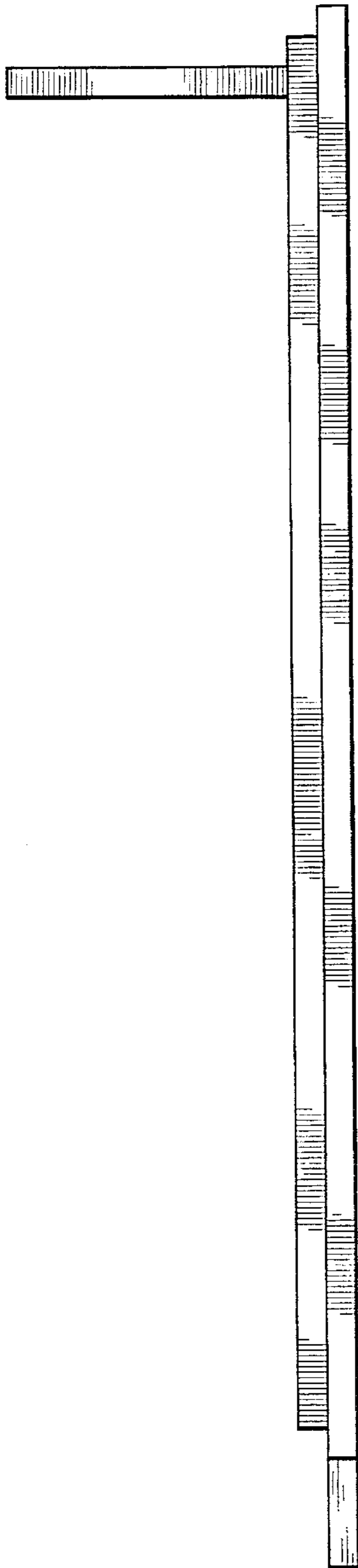

FIG. 4

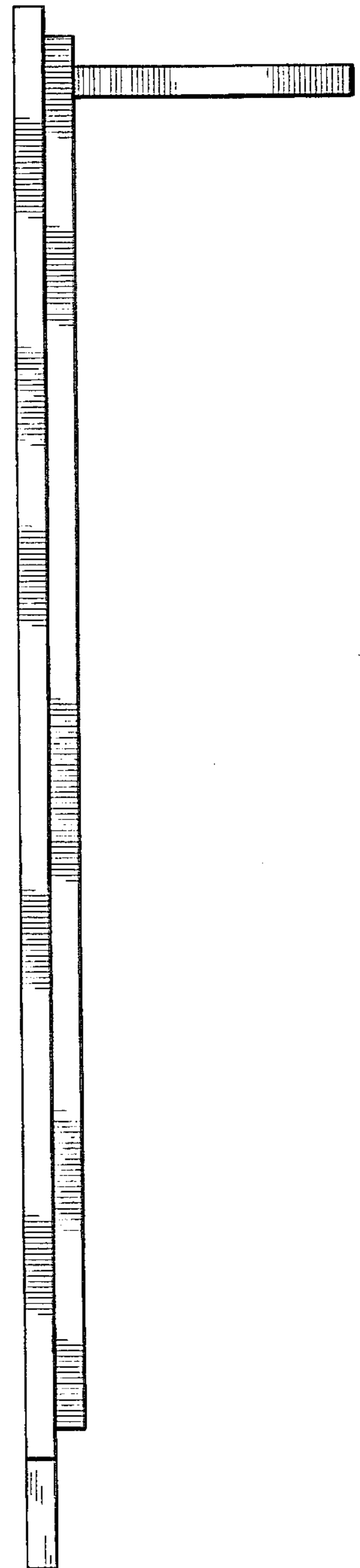

FIG. 5

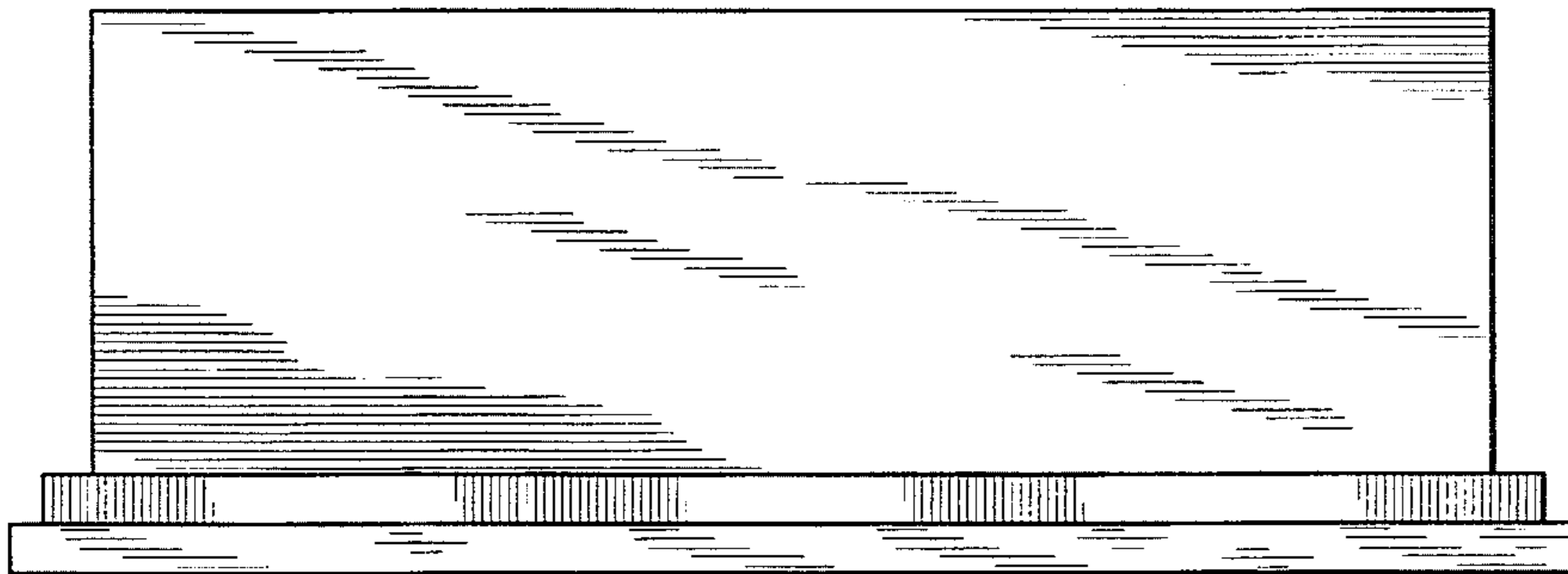

FIG. 6

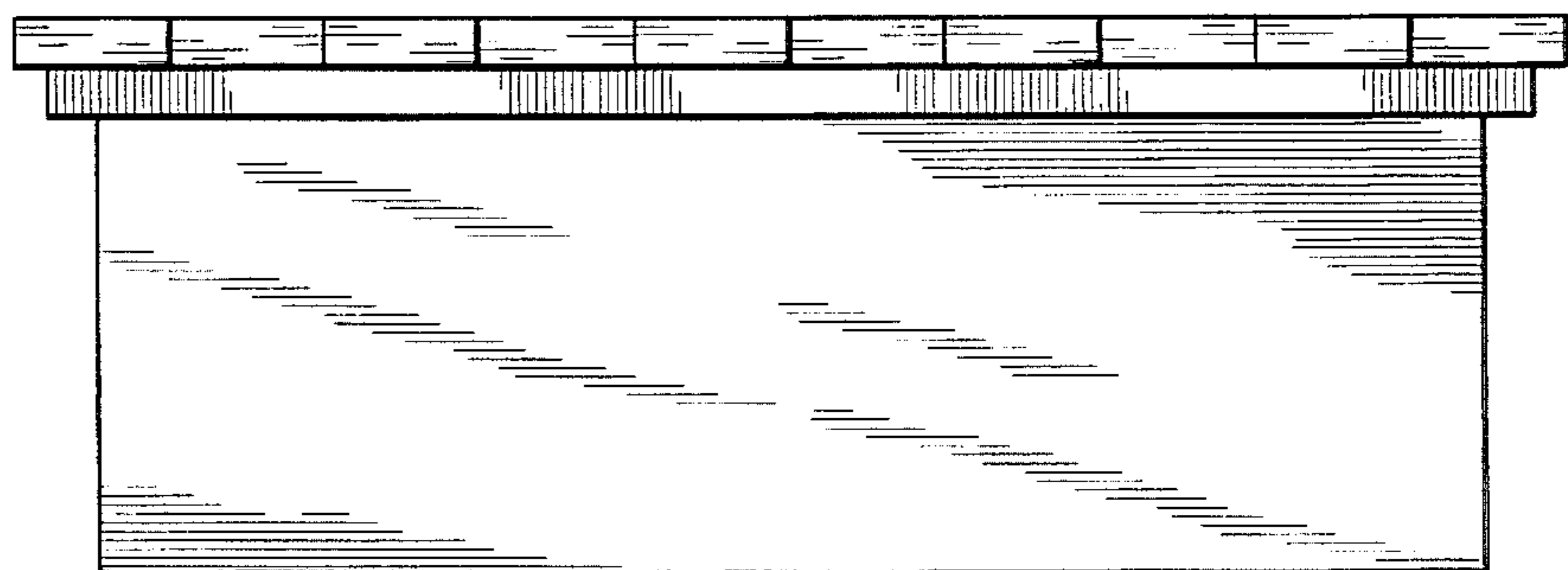

FIG. 7

