



US00D363889S

United States Patent [19]

Dickau et al.

[11] Patent Number: **Des. 363,889**

[45] Date of Patent: ****Nov. 7, 1995**

[54] **EQUIPMENT HOUSING**

[75] Inventors: **Ewald F. Dickau**, Glastonbury, Conn.;
David G. Honan, Concord, Mass.

[73] Assignee: **Loctite Corporation**, Hartford, Conn.

[**] Term: **14 Years**

[21] Appl. No.: **19,043**

[22] Filed: **Feb. 22, 1994**

[52] U.S. Cl. **D10/96**; D23/200

[58] Field of Search D23/200, 207-210;
210/198.1, 348; D10/46, 96, 101, 75; D15/7,
9; D13/184

[56] **References Cited**

U.S. PATENT DOCUMENTS

D. 247,480	3/1978	Gilson	D10/96
D. 261,739	11/1981	Leibson	D10/101
3,142,639	7/1964	Baer	210/198.1
3,356,460	12/1967	King et al.	210/198.1

Primary Examiner—A. Hugo Word
Assistant Examiner—Robin V. Taylor
Attorney, Agent, or Firm—Edward K. Welch, II; Eugene F. Miller; Dana M. Bosco

[57] **CLAIM**

The ornamental design for an equipment housing, as shown and described.

DESCRIPTION

FIG. 1 is a front perspective view of an equipment housing incorporating our new design;
FIG. 2 is a front elevational view of the housing of FIG. 1;
FIG. 3 is a top plan view of the housing of FIG. 1;
FIG. 4 is a left side elevational view of the housing of FIG. 1;
FIG. 5 is a rear elevational view of the housing of FIG. 1;
FIG. 6 is a bottom plan view of the housing of FIG. 1;
FIG. 7 is a front right top perspective view of a second embodiment of the equipment housing incorporating our new design;
FIG. 8 is a front elevational view of the housing of FIG. 7;
FIG. 9 is a top plan view of the housing of FIG. 7;
FIG. 10 is a left side elevational view of the housing of FIG. 7;
FIG. 11 is a rear elevational view of the housing of FIG. 7; and,
FIG. 12 is a bottom plan view of the housing of FIG. 7.

1 Claim, 6 Drawing Sheets

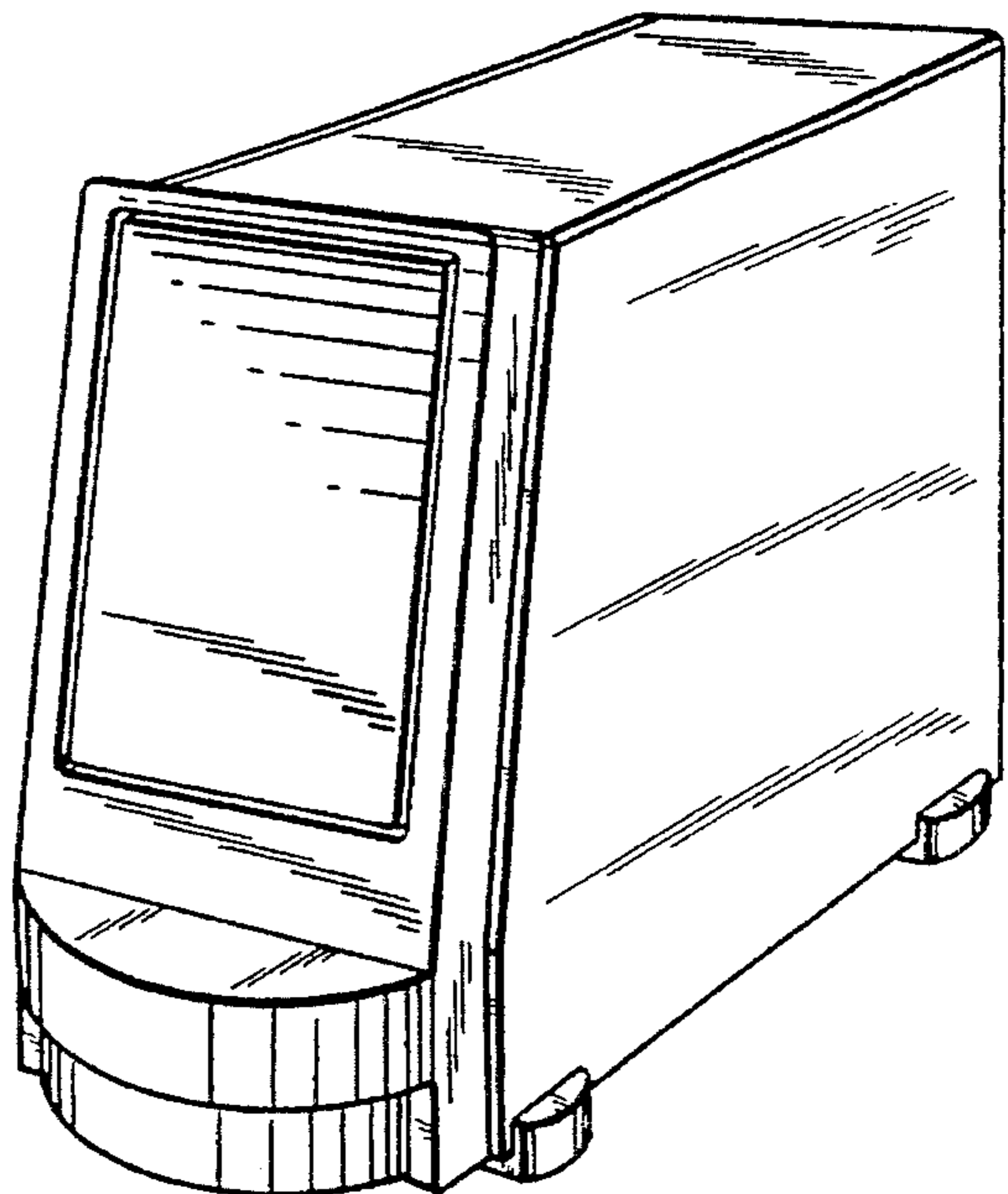
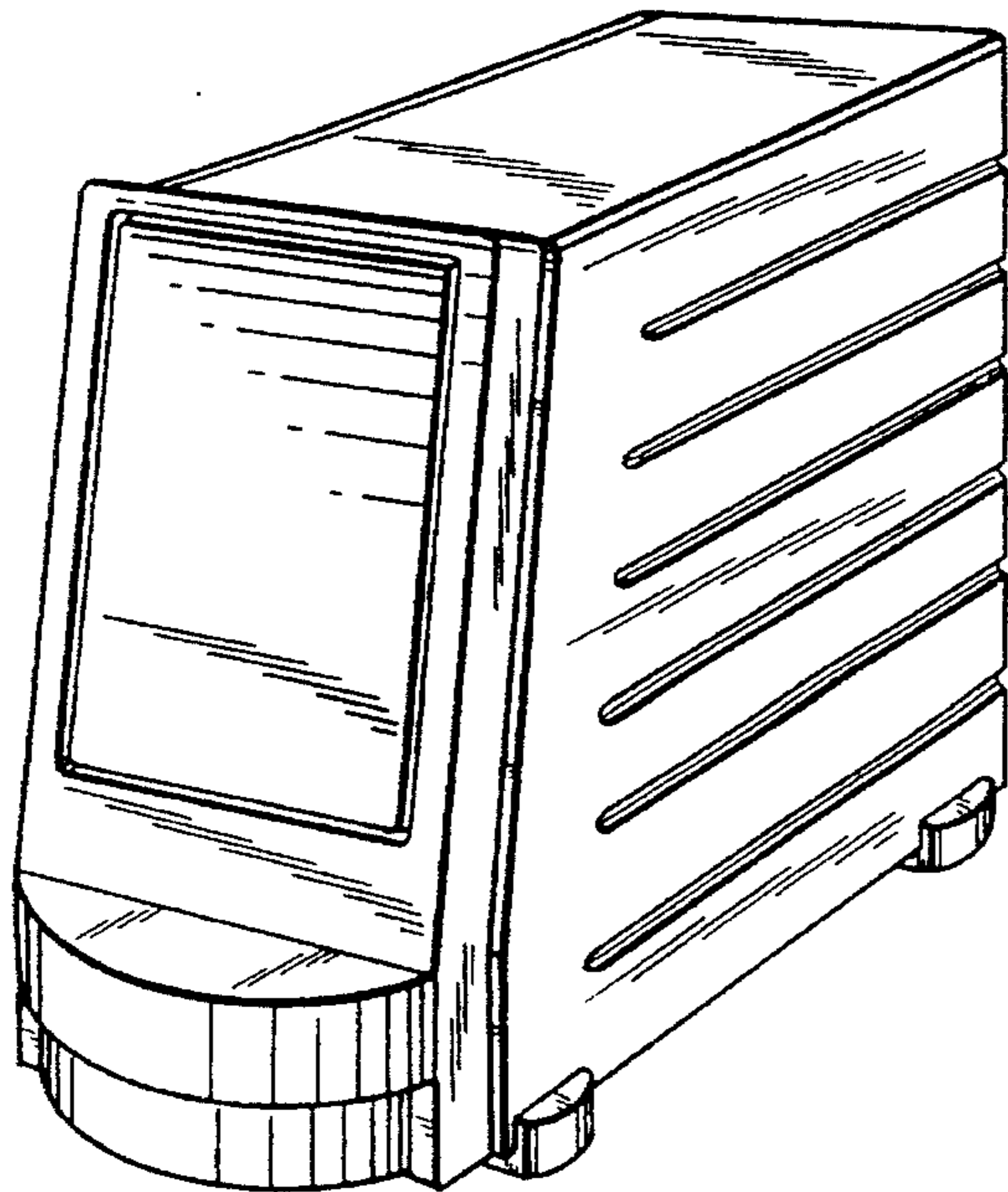

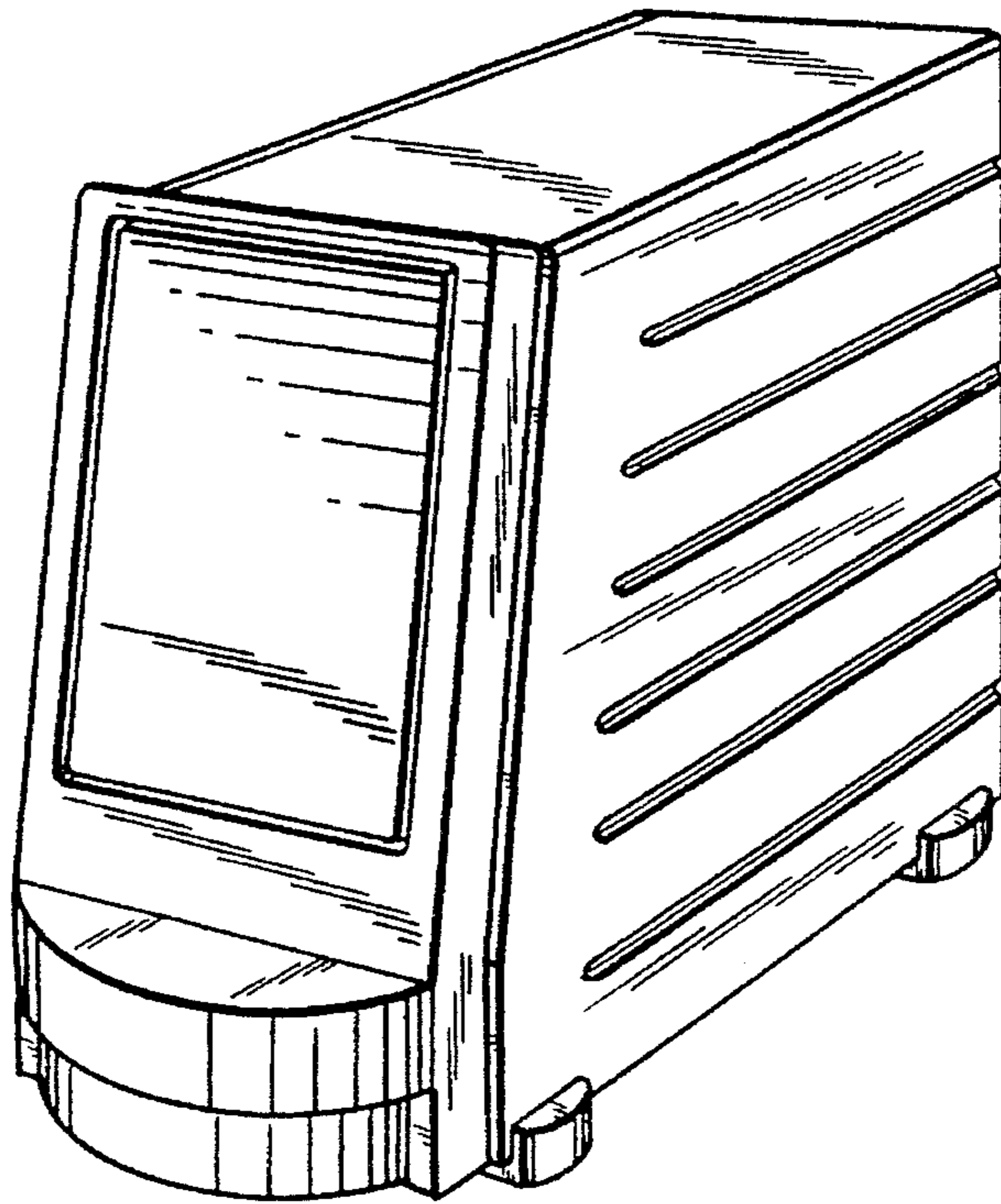

FIG. 1

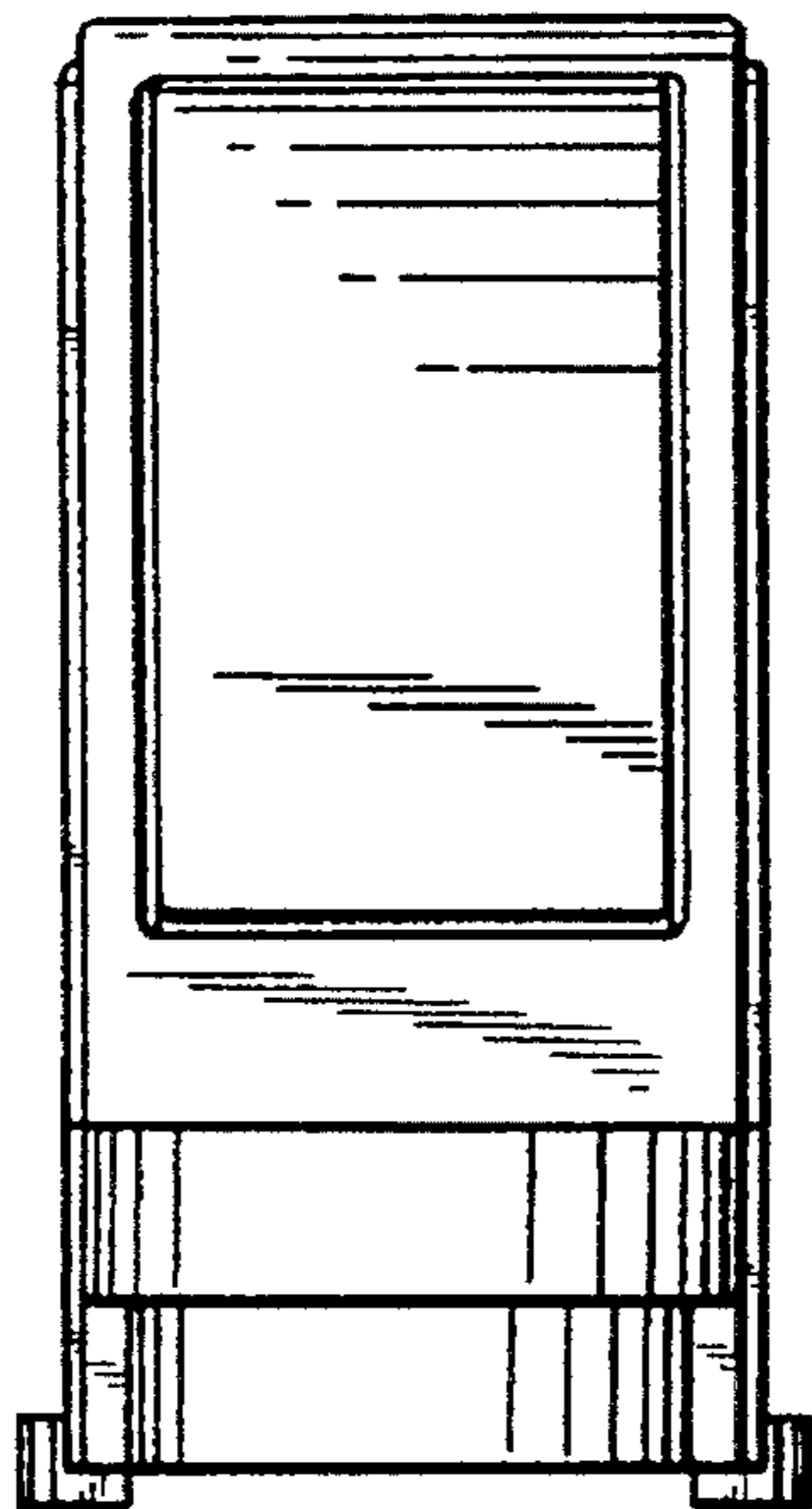

FIG. 2

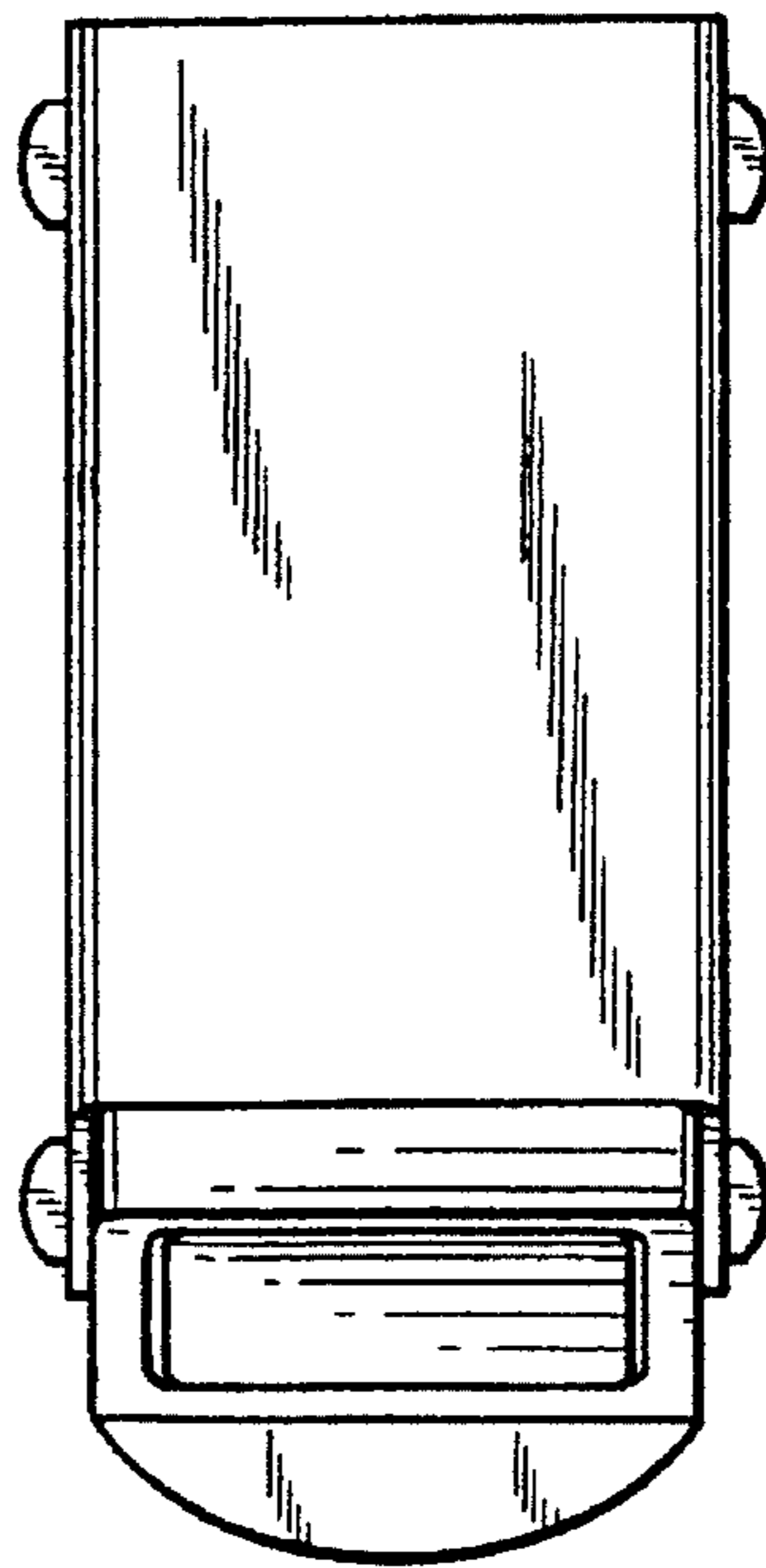

FIG. 3

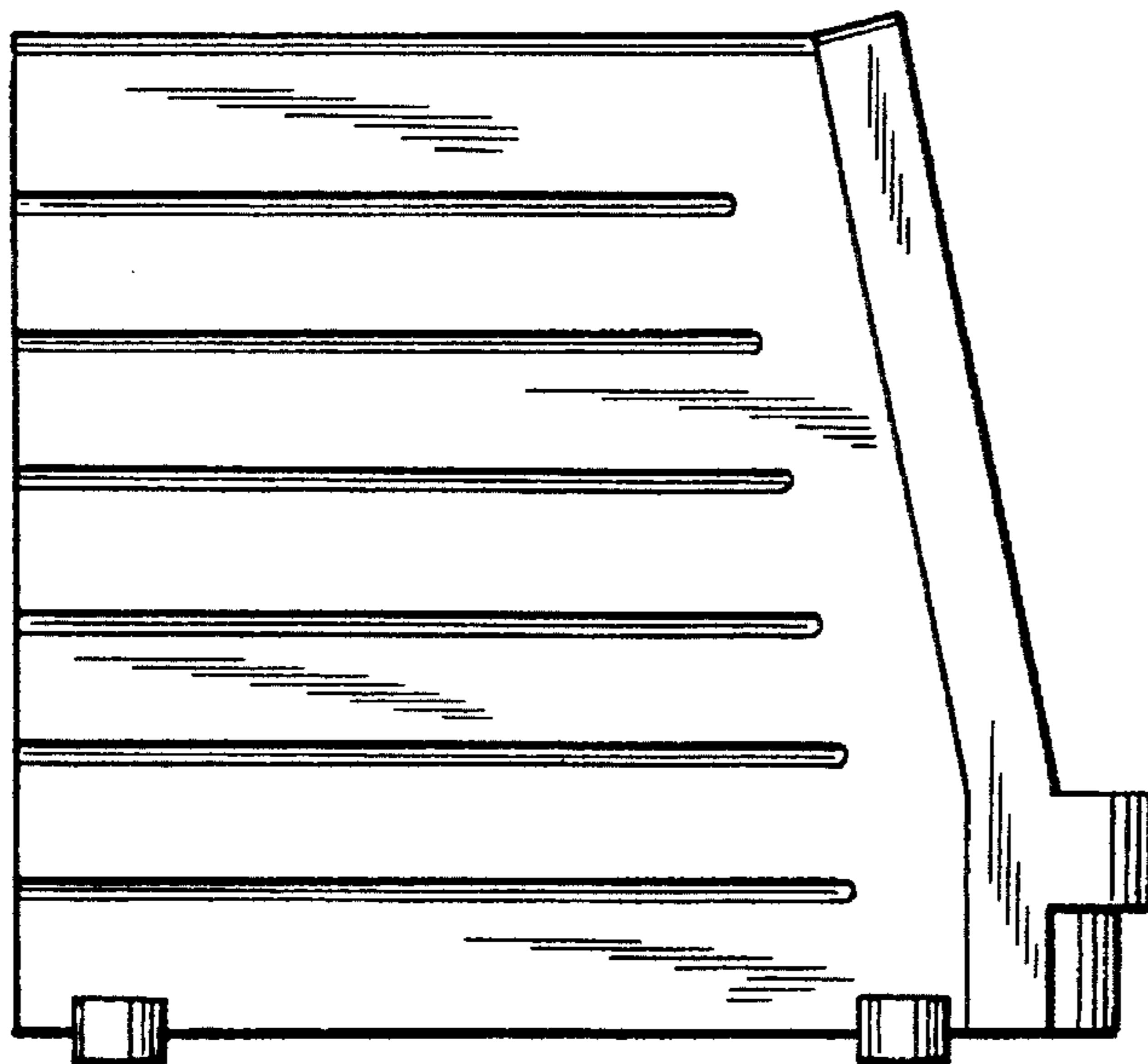

FIG. 4

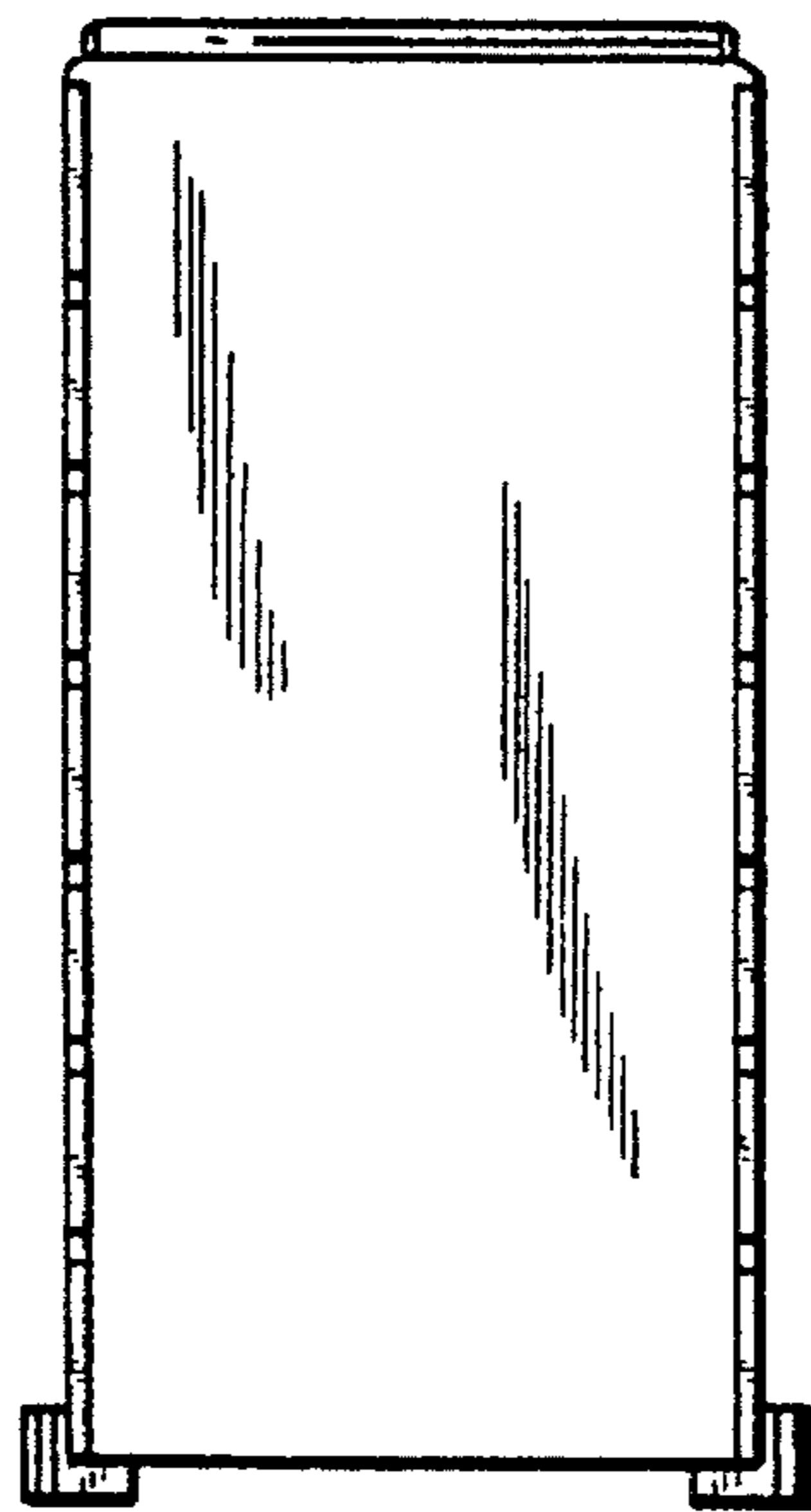

FIG. 5

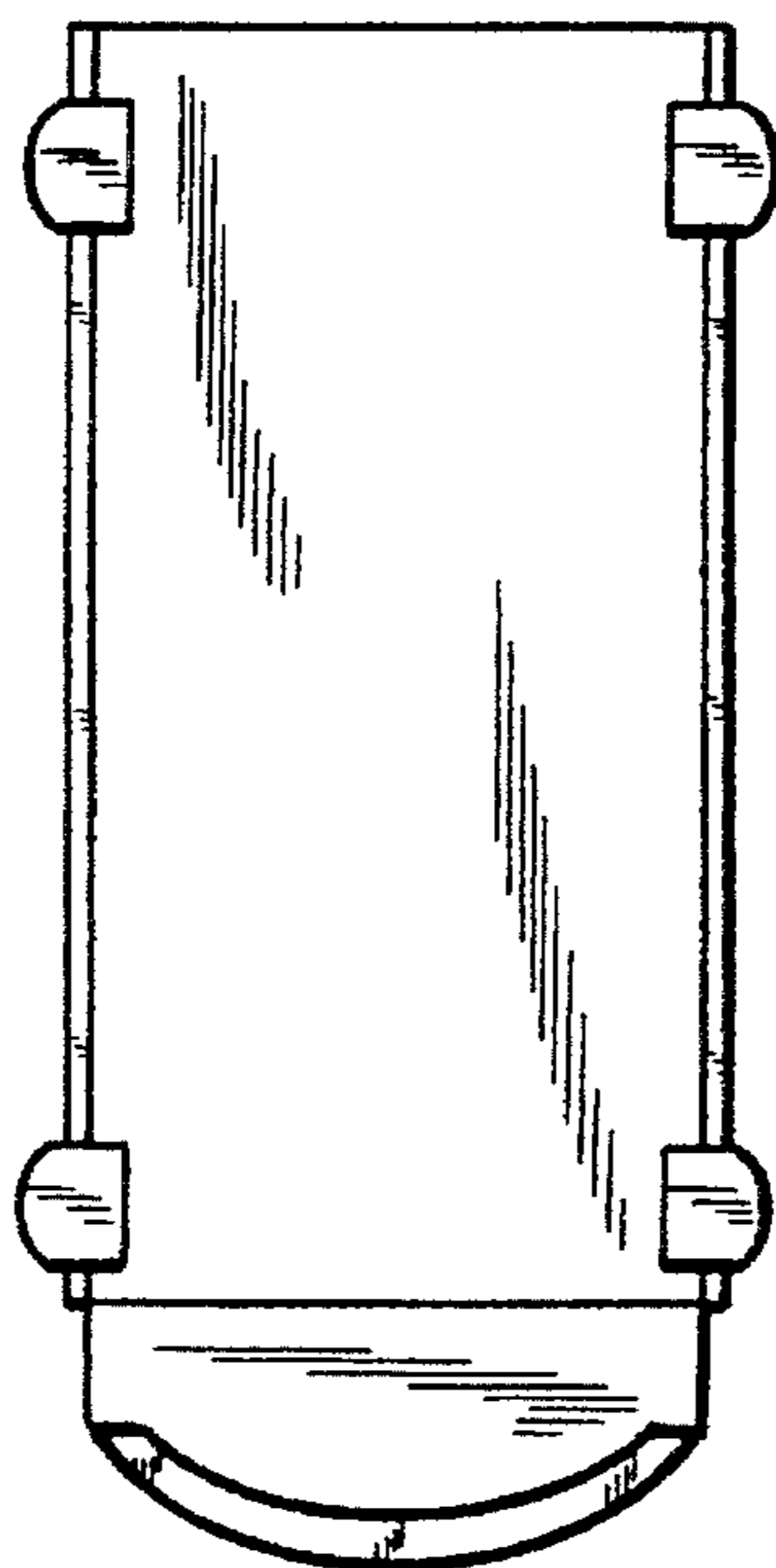

FIG. 6

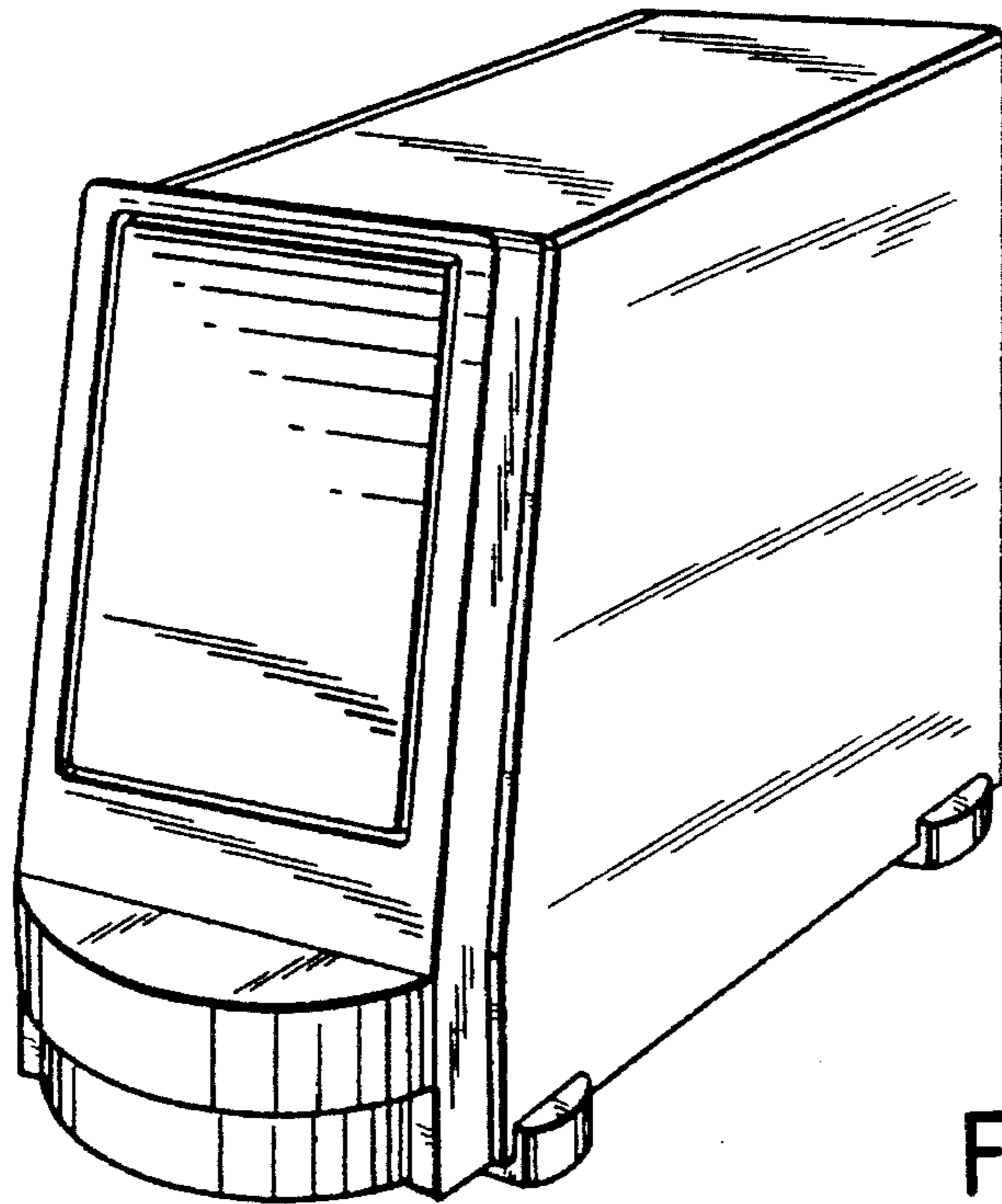

FIG. 7

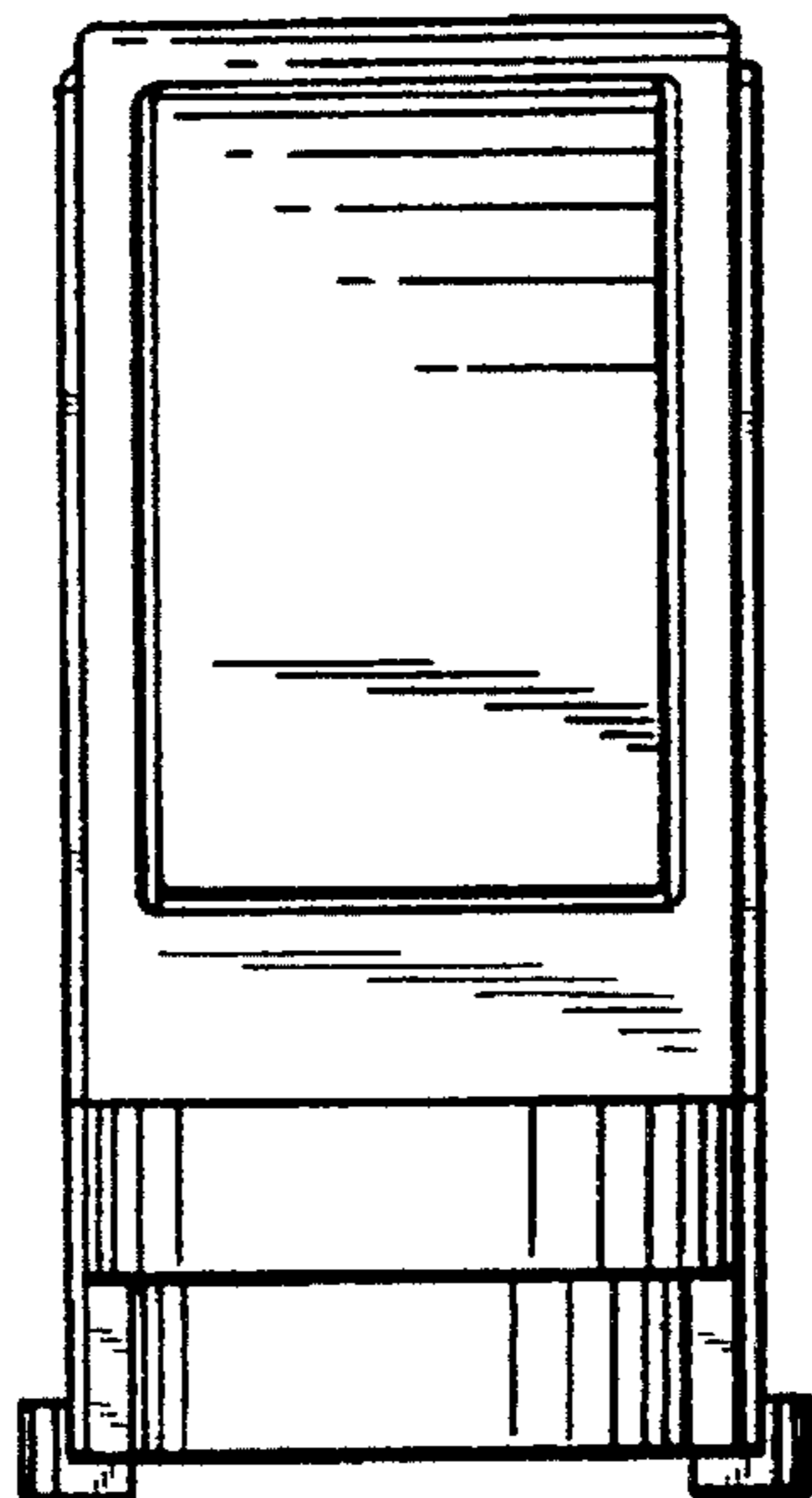

FIG. 8

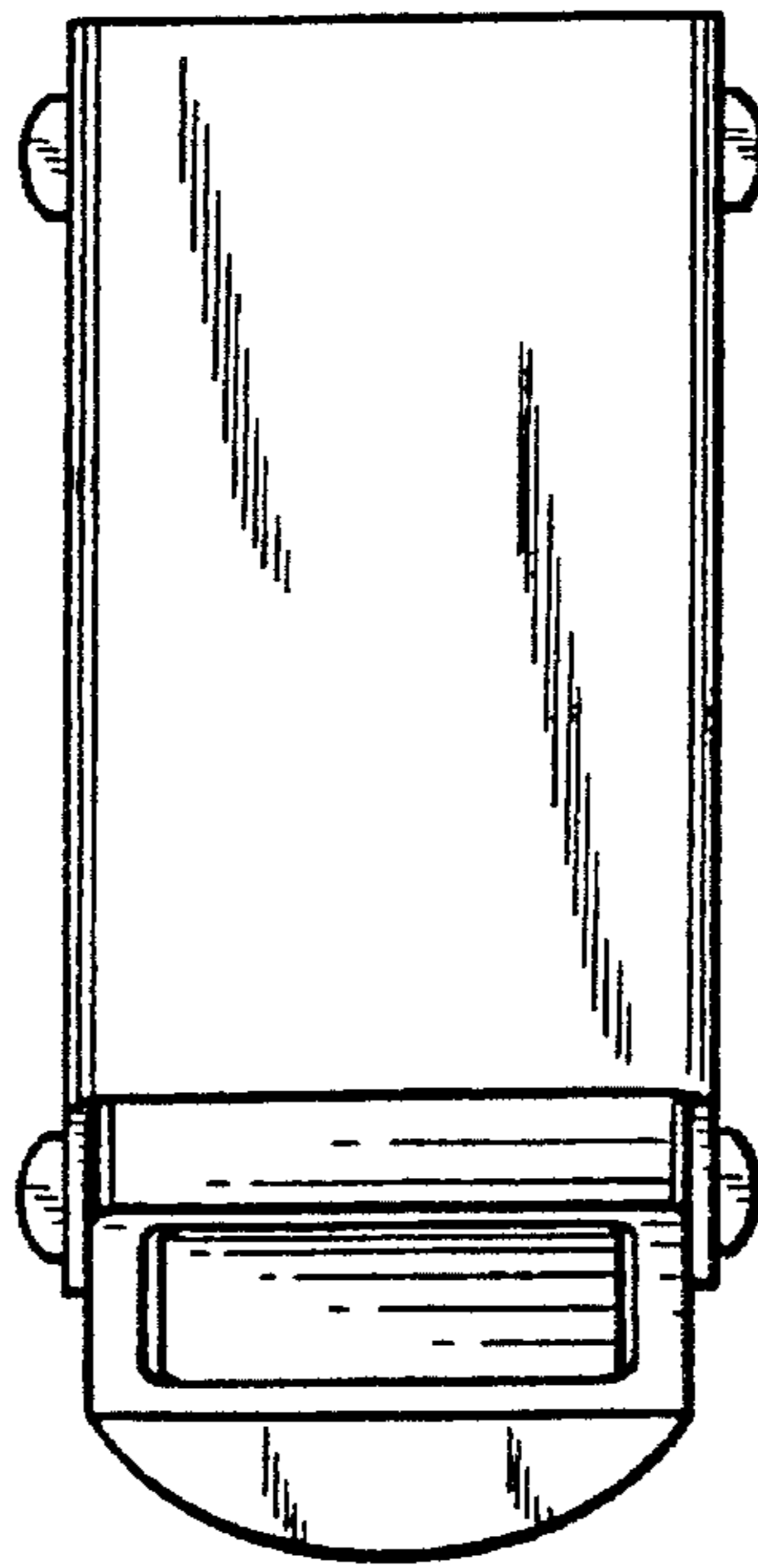

FIG. 9

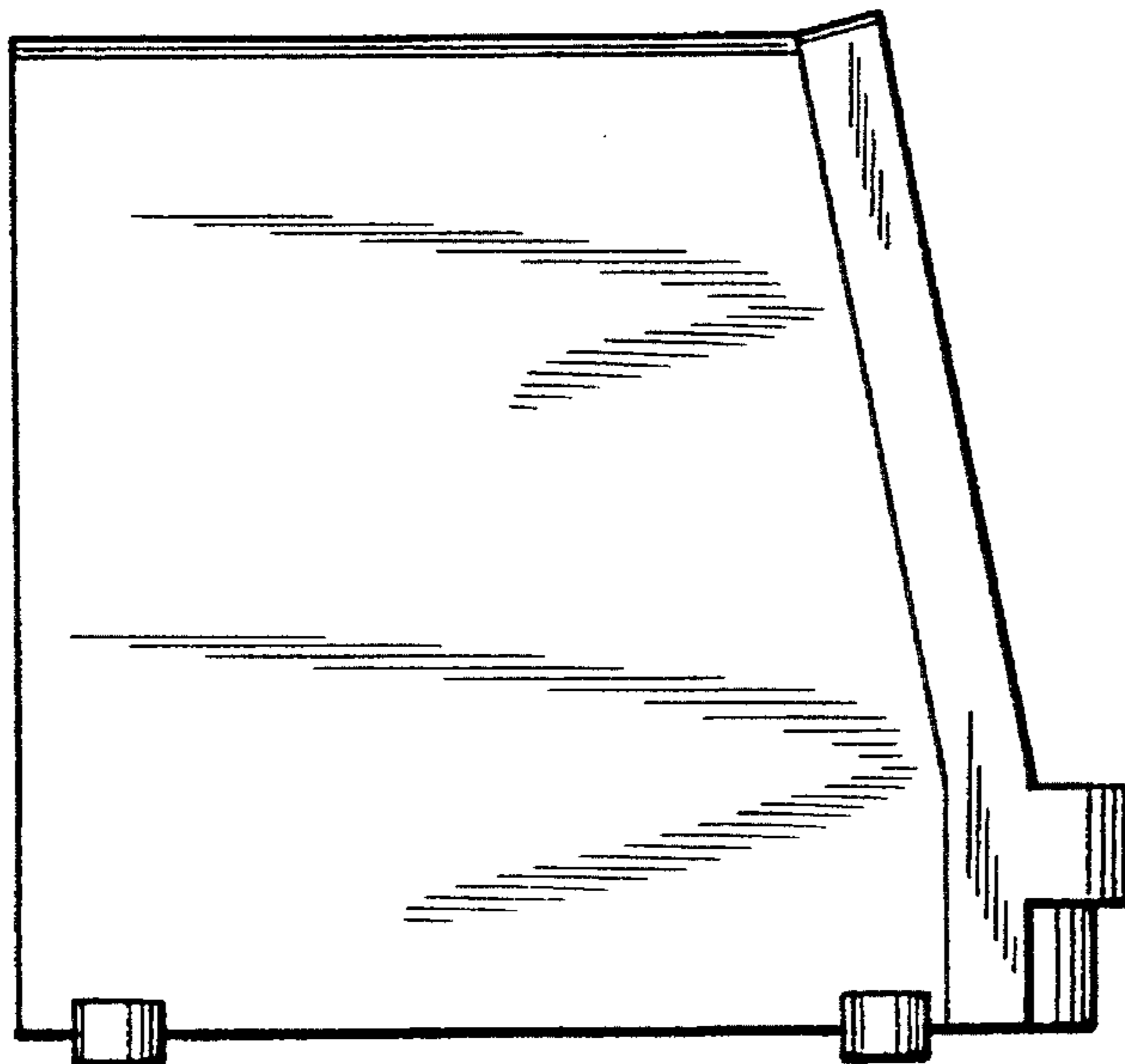

FIG. 10

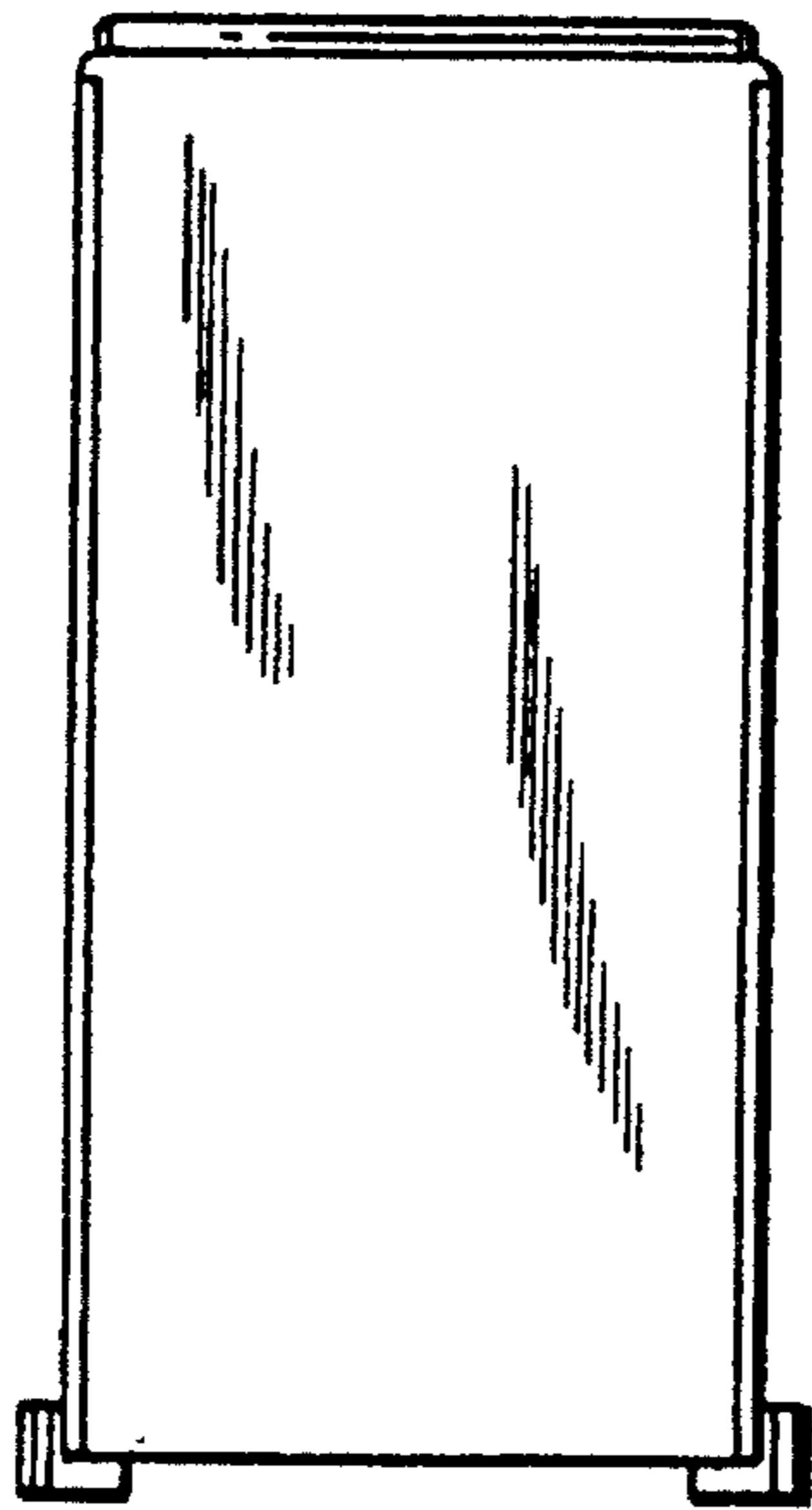

FIG. 11

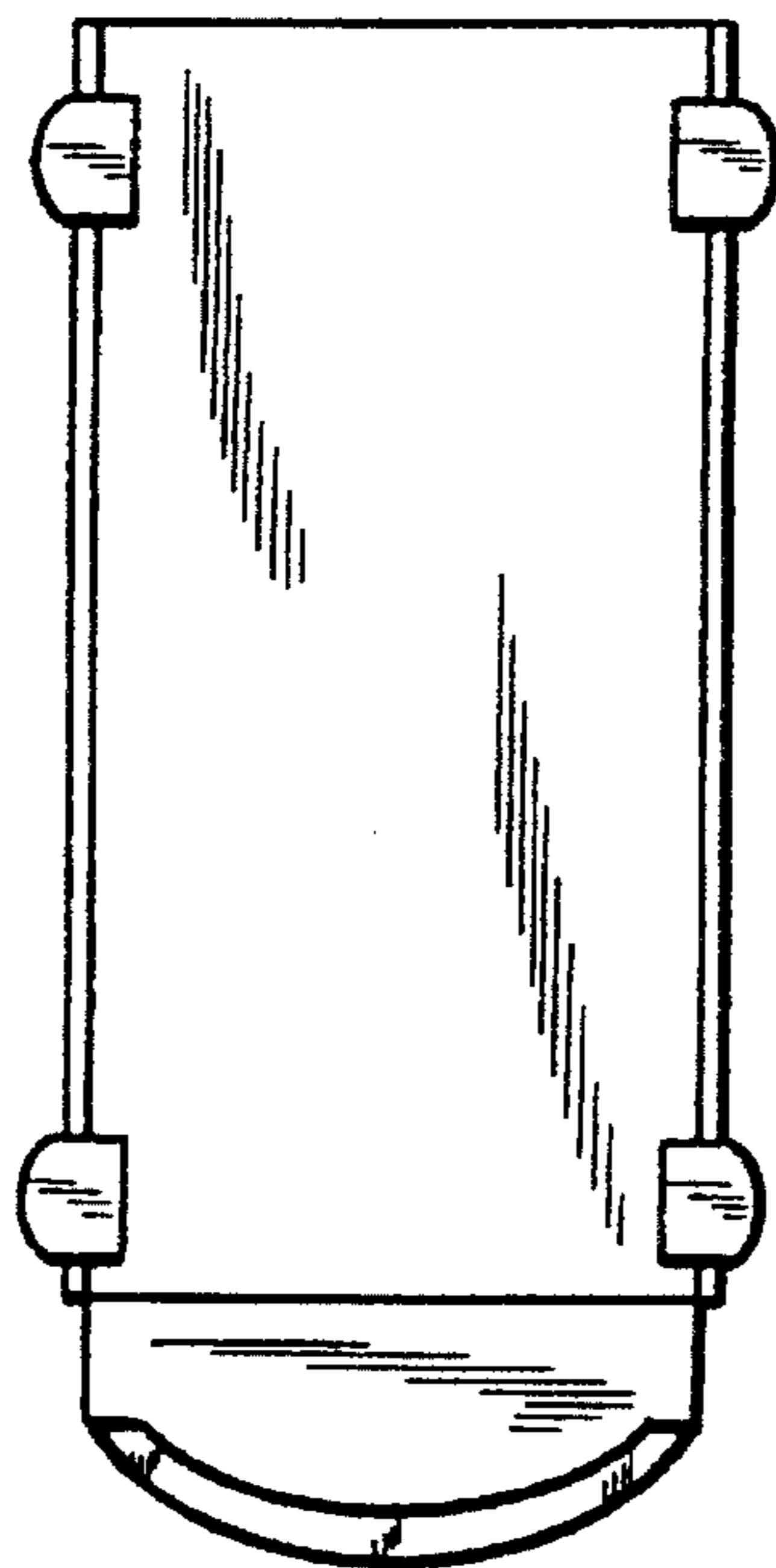

FIG. 12