



US00D363834S

United States Patent [19]
Thompson

[11] **Patent Number: Des. 363,834**
[45] **Date of Patent: **Nov. 7, 1995**

[54] **UTILITY CABINET**

[75] Inventor: **David W. Thompson**, Dublin, Ohio

[73] Assignee: **Schottenstein Stores Corporation**,
Columbus, Ohio

[**] Term: **14 Years**

[21] Appl. No.: **18,200**

[22] Filed: **Feb. 1, 1994**

[52] U.S. Cl. **D6/438**

[58] Field of Search D6/432-448, 396,
D6/397, 477-479; 312/204, 257

[56] **References Cited**

U.S. PATENT DOCUMENTS

D. 26,416	12/1896	Pigg	D6/439 X
D. 62,867	8/1923	Kuklinski	D6/438
D. 64,389	4/1924	Arons	D6/439
D. 65,769	10/1924	Bockstege	D6/439 X
D. 69,938	4/1926	Erskine	D6/438
D. 91,298	1/1934	McClure	D6/438

Primary Examiner—Carmen H. Vales-Lado
Attorney, Agent, or Firm—Wood, Herron & Evans

[57] **CLAIM**

The ornamental design for a utility cabinet, as shown and described.

DESCRIPTION

FIG. 1 is a front and left side perspective view of a utility

cabinet showing my new design;
 FIG. 2 is a front elevational view of the utility cabinet of FIG. 1;
 FIG. 3 is a left side elevational view thereof, the right side being a mirror image thereof;
 FIG. 4 is a top plan view thereof;
 FIG. 5 is a bottom plan view thereof;
 FIG. 6 is a rear elevational view of the utility cabinet of FIG. 1;
 FIG. 7 is a perspective view, similar to FIG. 1, with the utility shelf for the cabinet shown extended;
 FIG. 8 is a left side elevational view with the shelf shown extended, the right side being a mirror image thereof;
 FIG. 9 is a reduced scale top plan view thereof;
 FIG. 10 is a reduced scale bottom plan view thereof;
 FIG. 11 is a perspective view of a second embodiment of the utility cabinet shown in FIG. 1;
 FIG. 12 is a front elevational view of the cabinet of FIG. 11;
 FIG. 13 is a left side elevational view of the cabinet of FIG. 11, the right side being a mirror image thereof;
 FIG. 14 is a top plan view of the cabinet of FIG. 11;
 FIG. 15 is a bottom plan view of the cabinet of FIG. 11;
 FIG. 16 is a rear elevational view of the cabinet of FIG. 11;
 FIG. 17 is a perspective view of a third embodiment of the utility cabinet shown in FIG. 1;
 FIG. 18 is a front elevational view thereof;
 FIG. 19 is a left side elevational view, the right side being a mirror image thereof;
 FIG. 20 is a top plan view thereof;
 FIG. 21 is a bottom plan view thereof; and,
 FIG. 22 is a rear elevational view thereof.

1 Claim, 10 Drawing Sheets

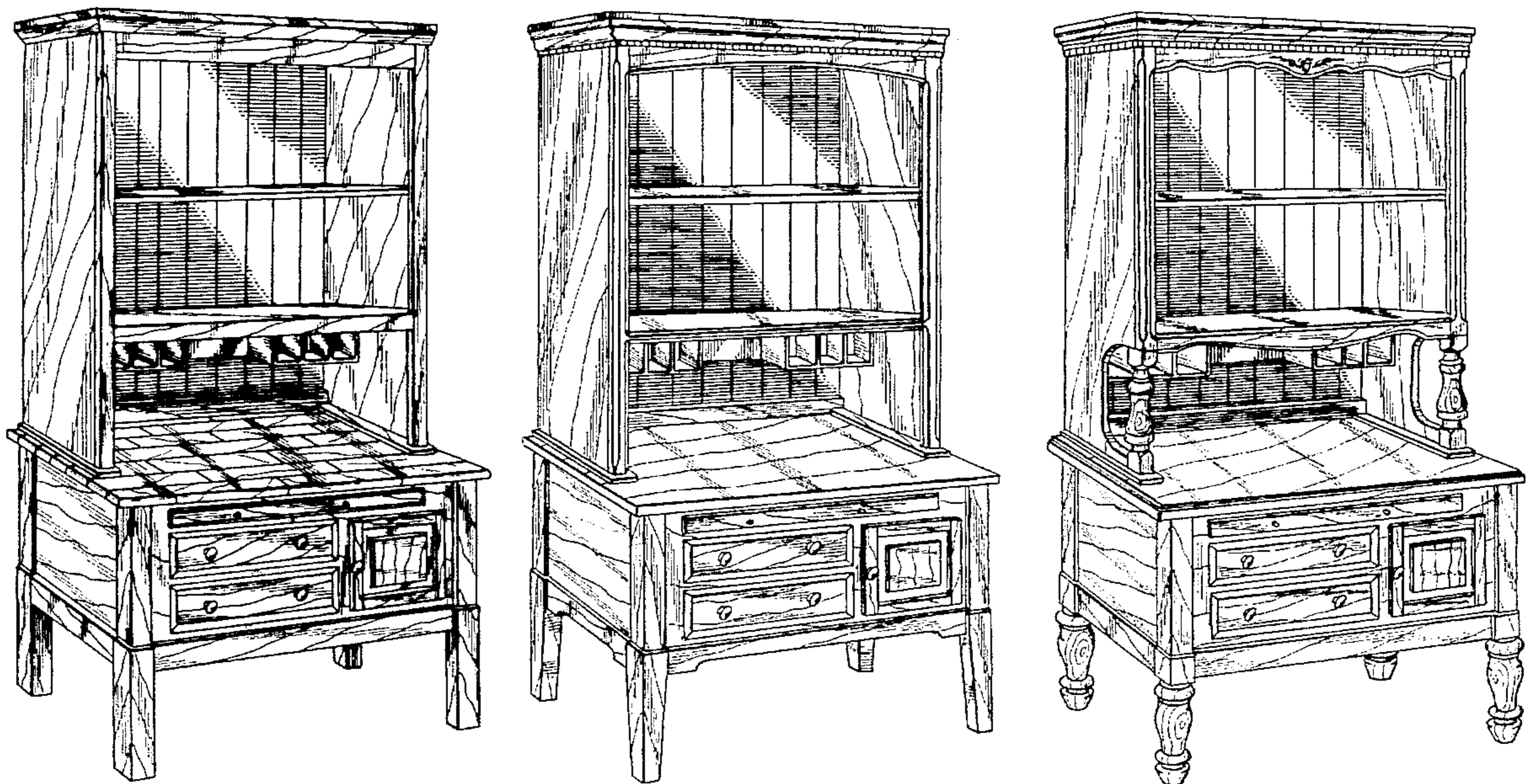

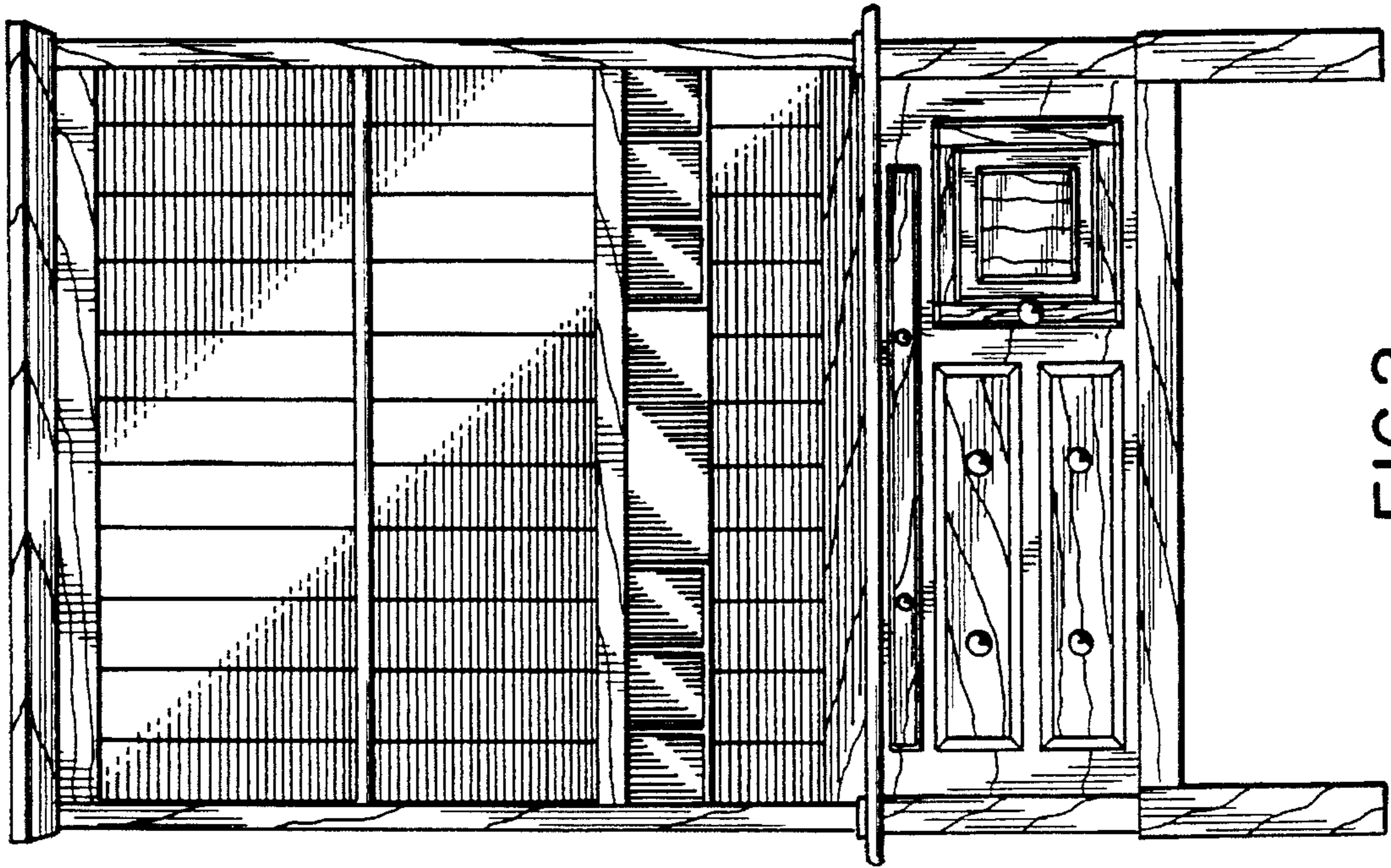

FIG. 2

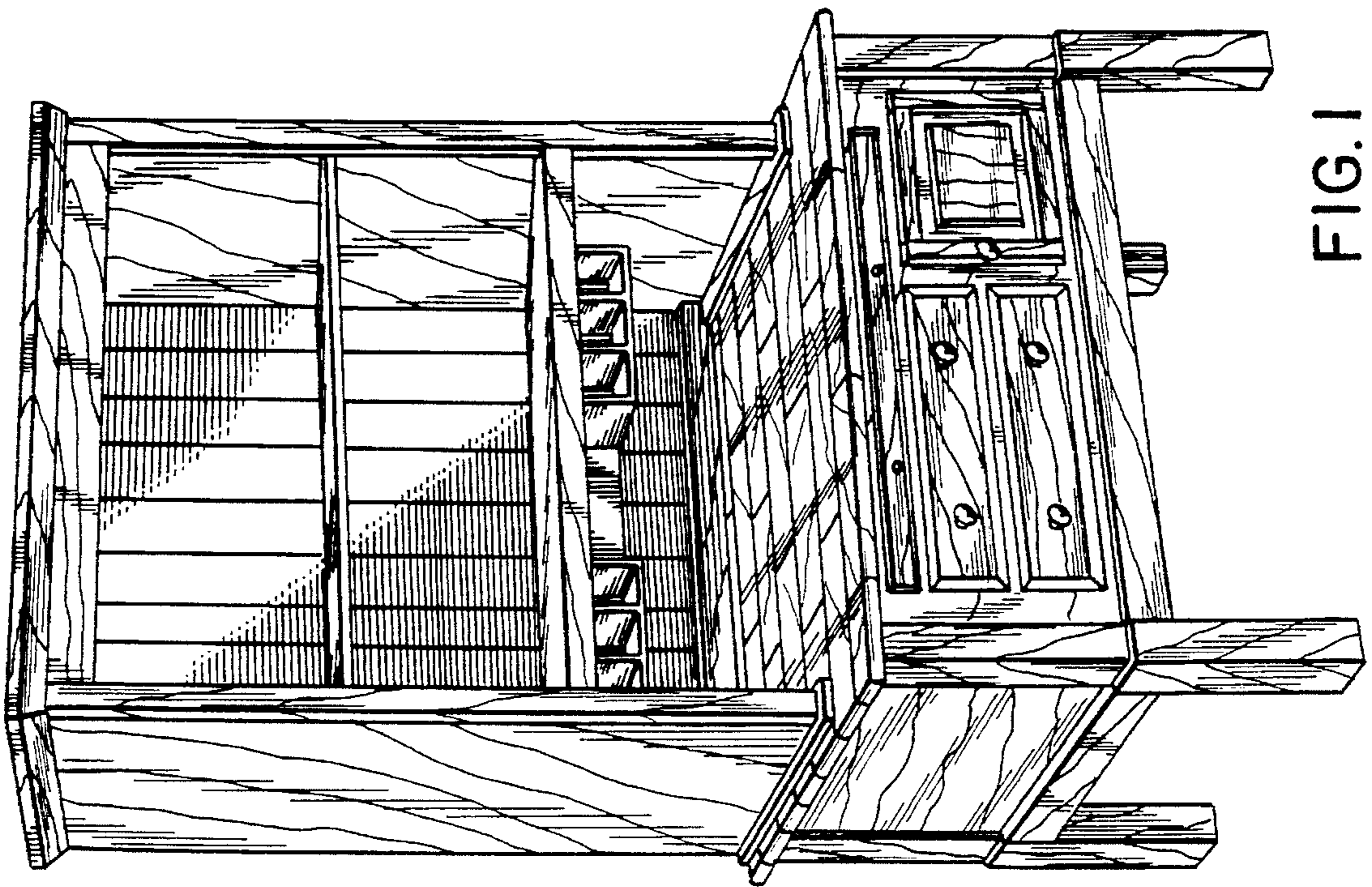

FIG. 1

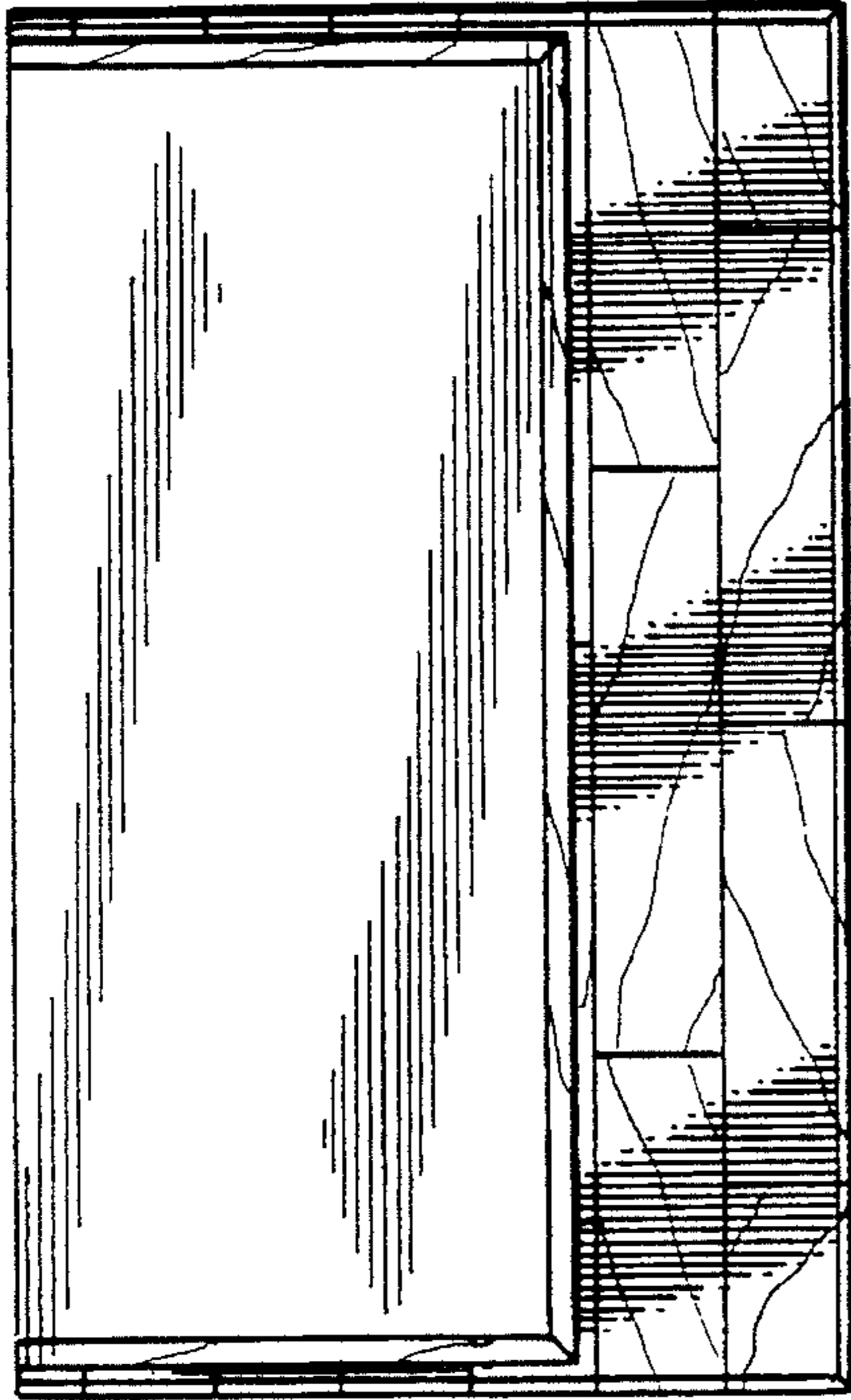

FIG. 4

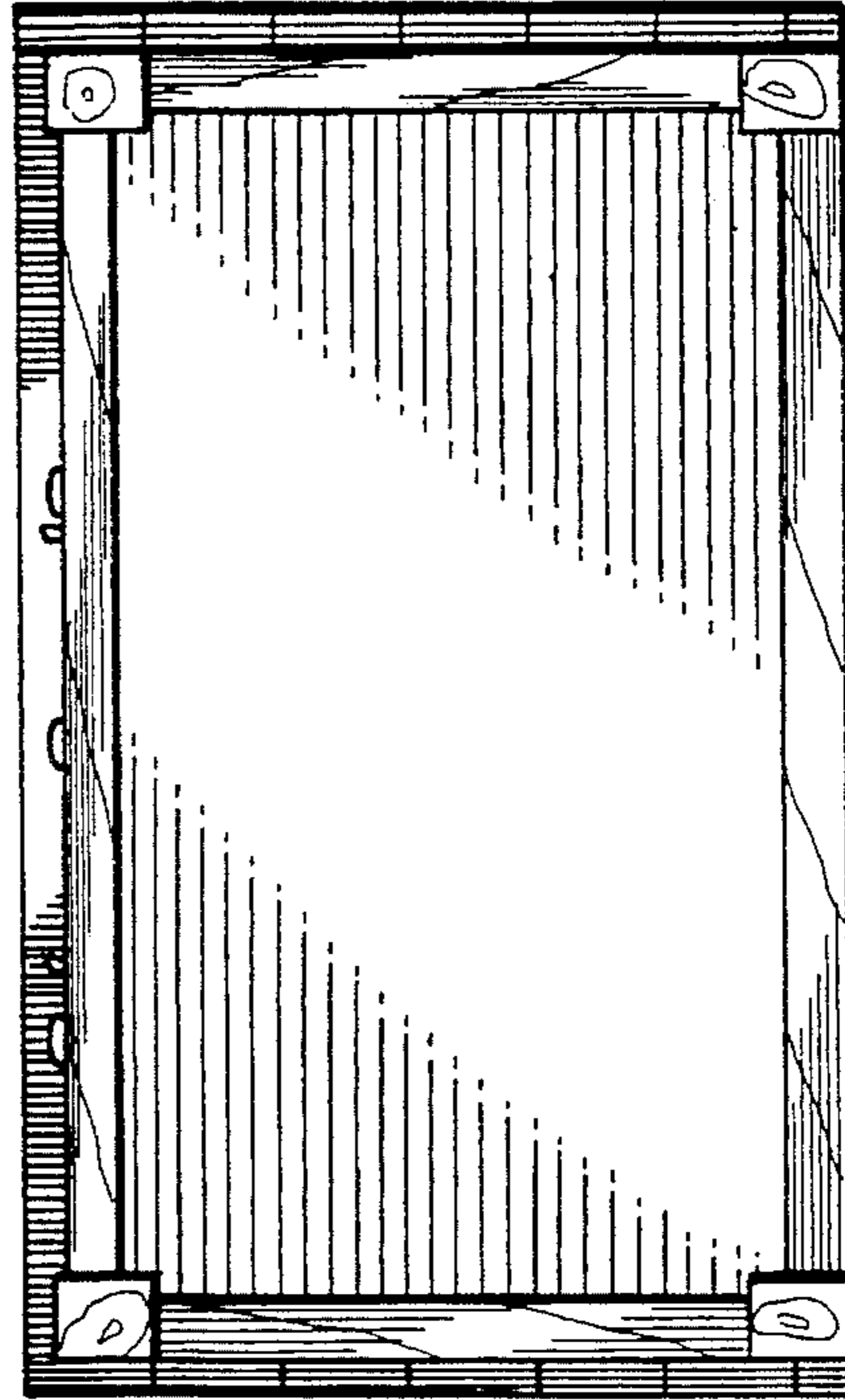

FIG. 5

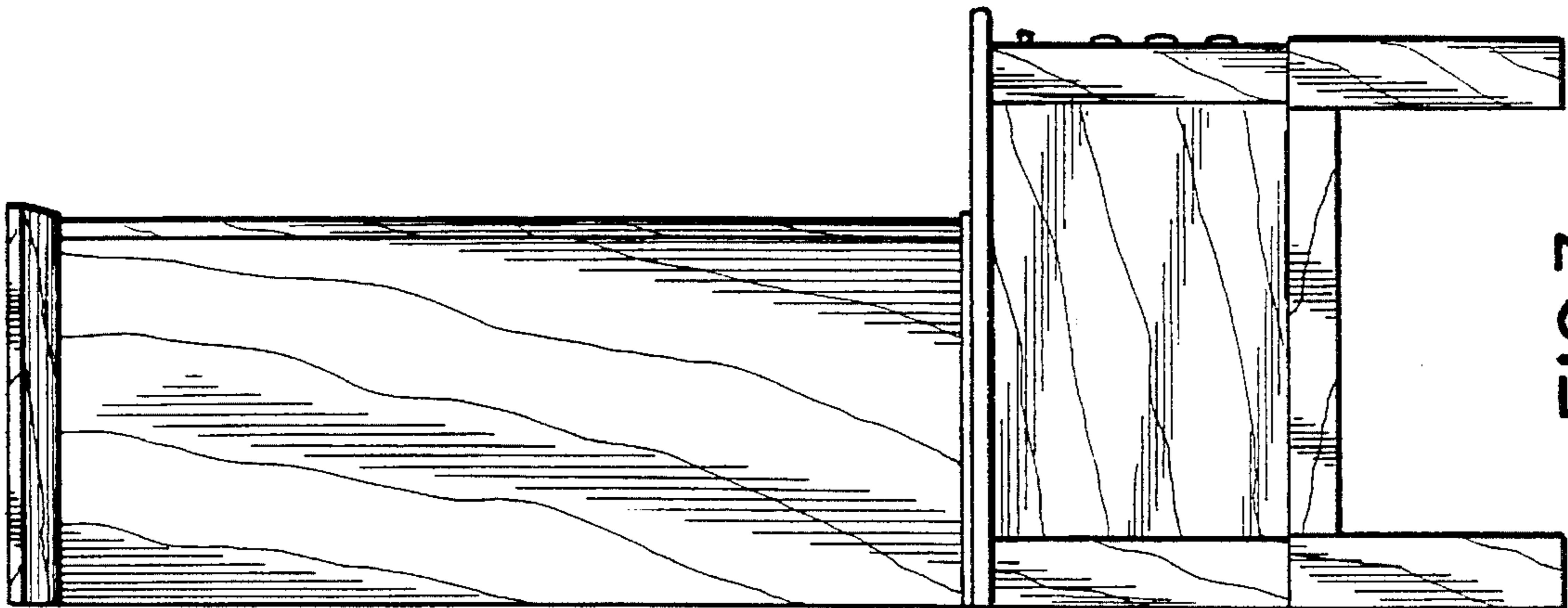

FIG. 3

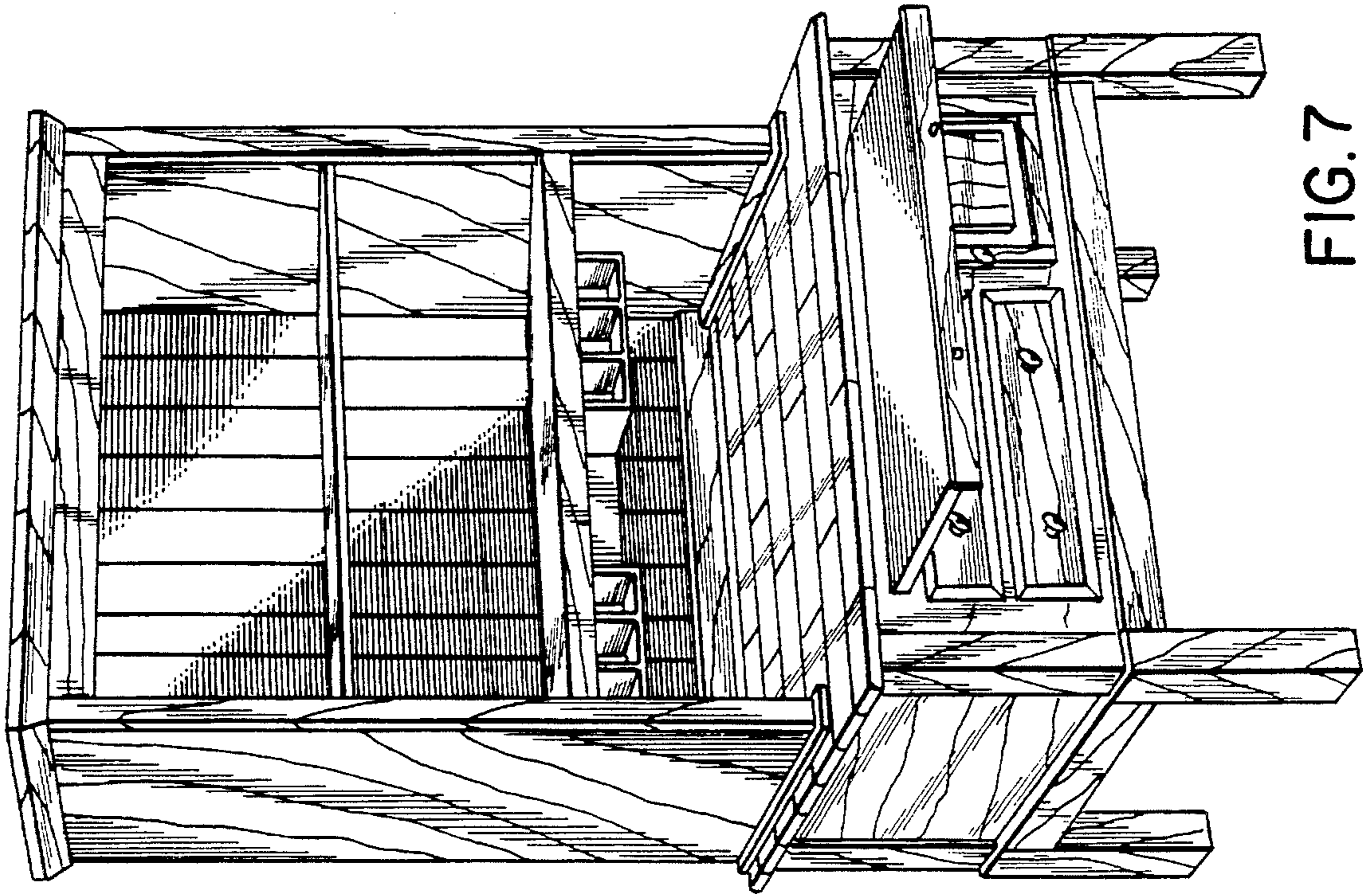

FIG. 7

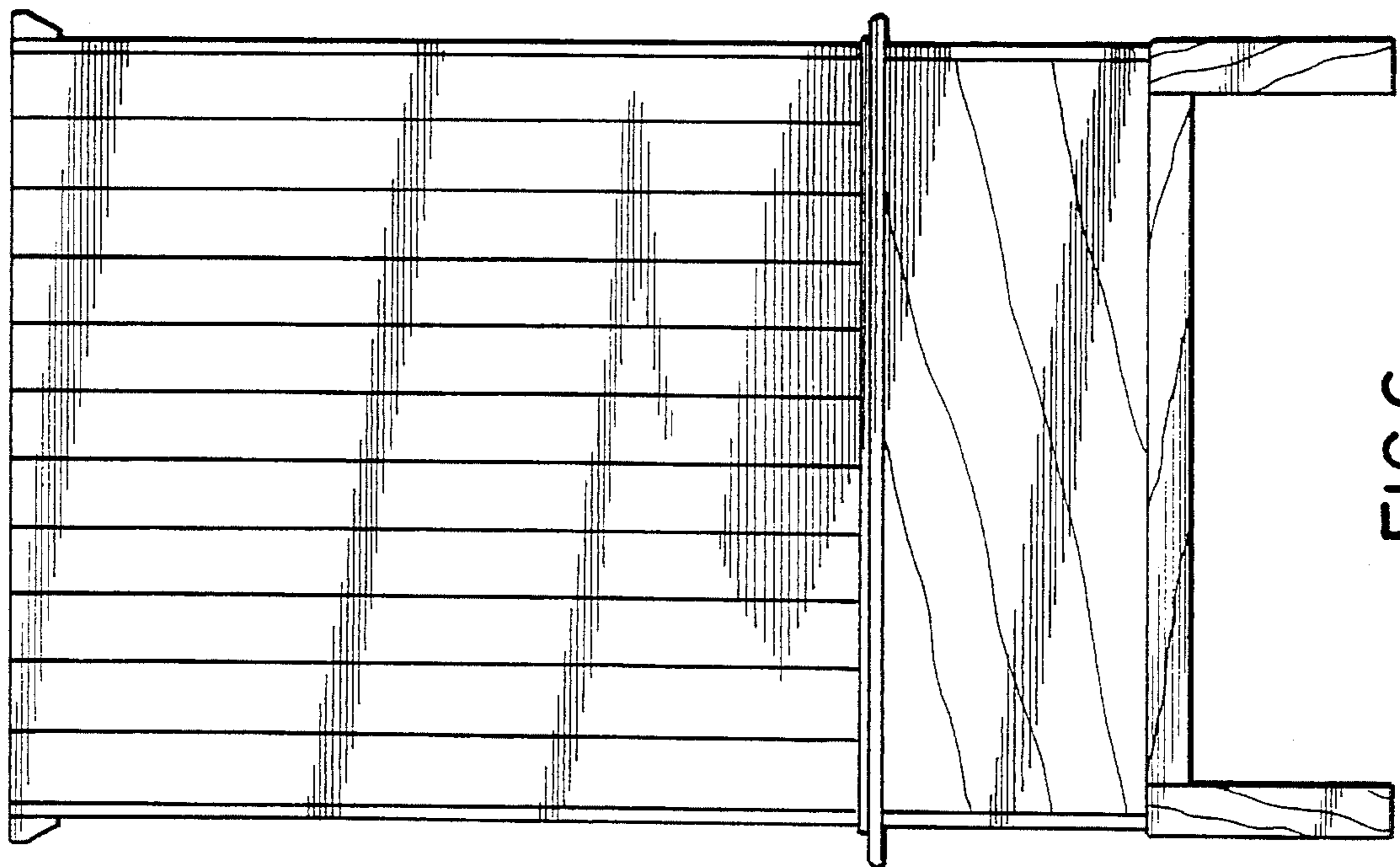

FIG. 6

FIG. 8

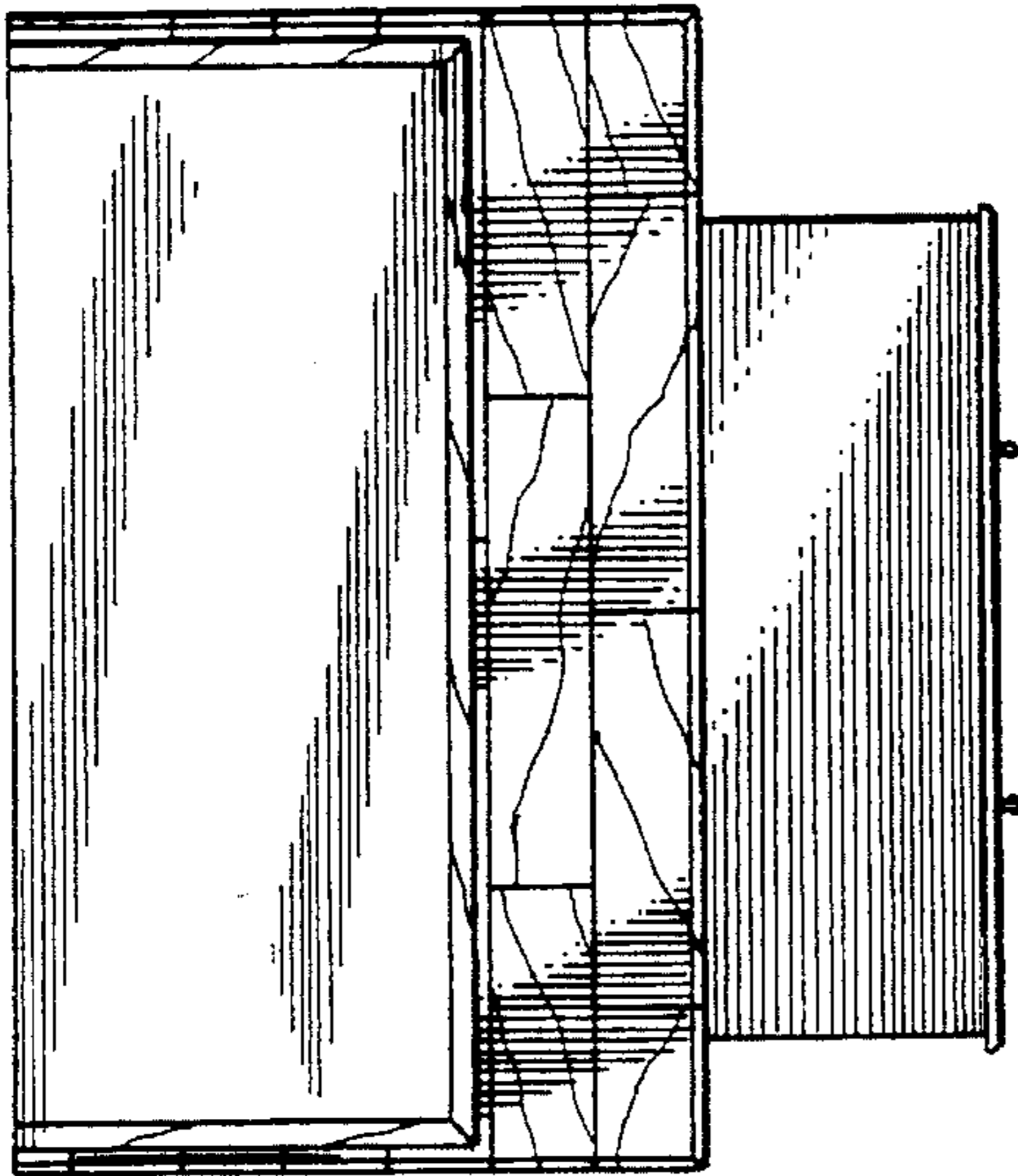
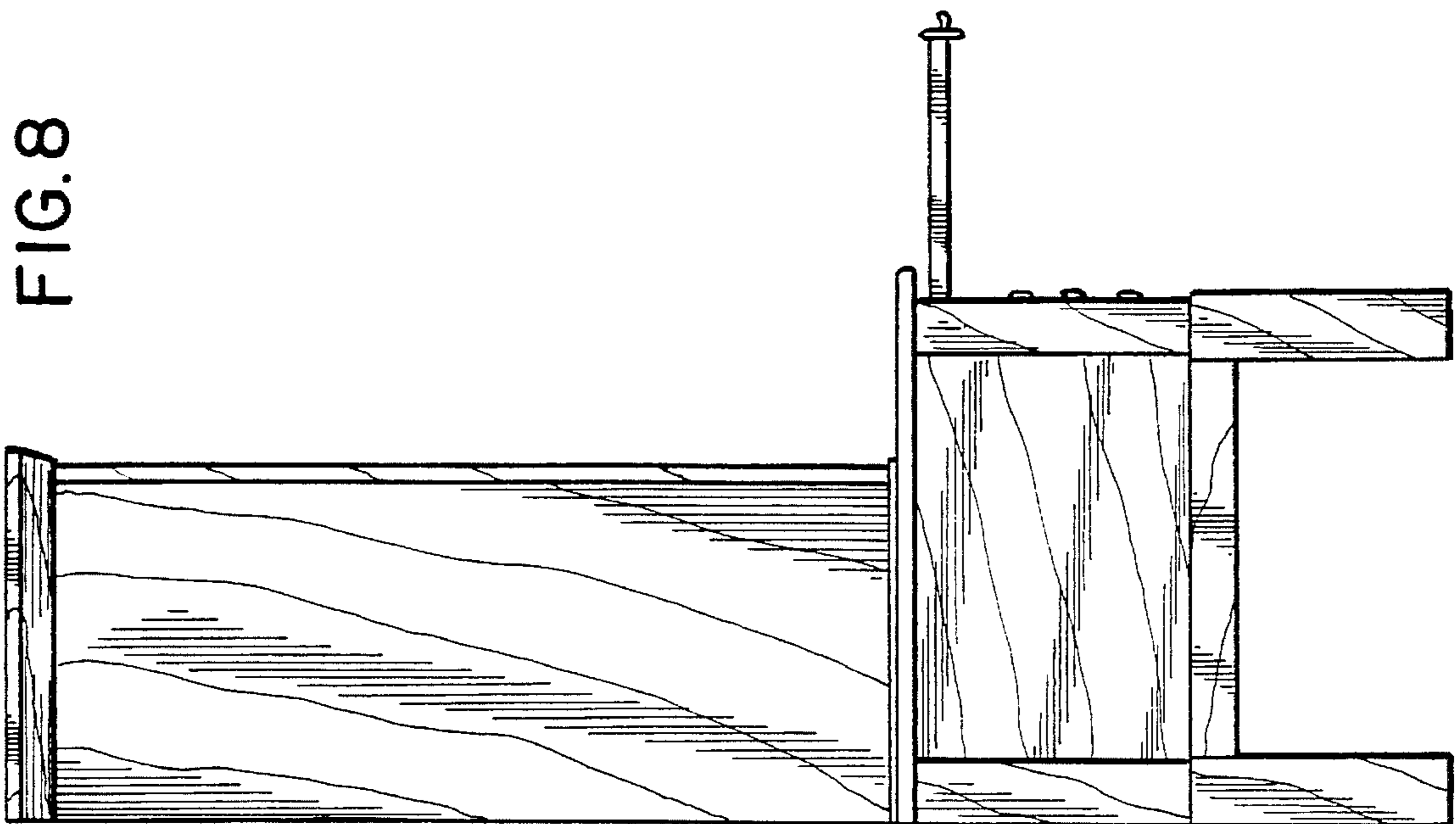

FIG. 9

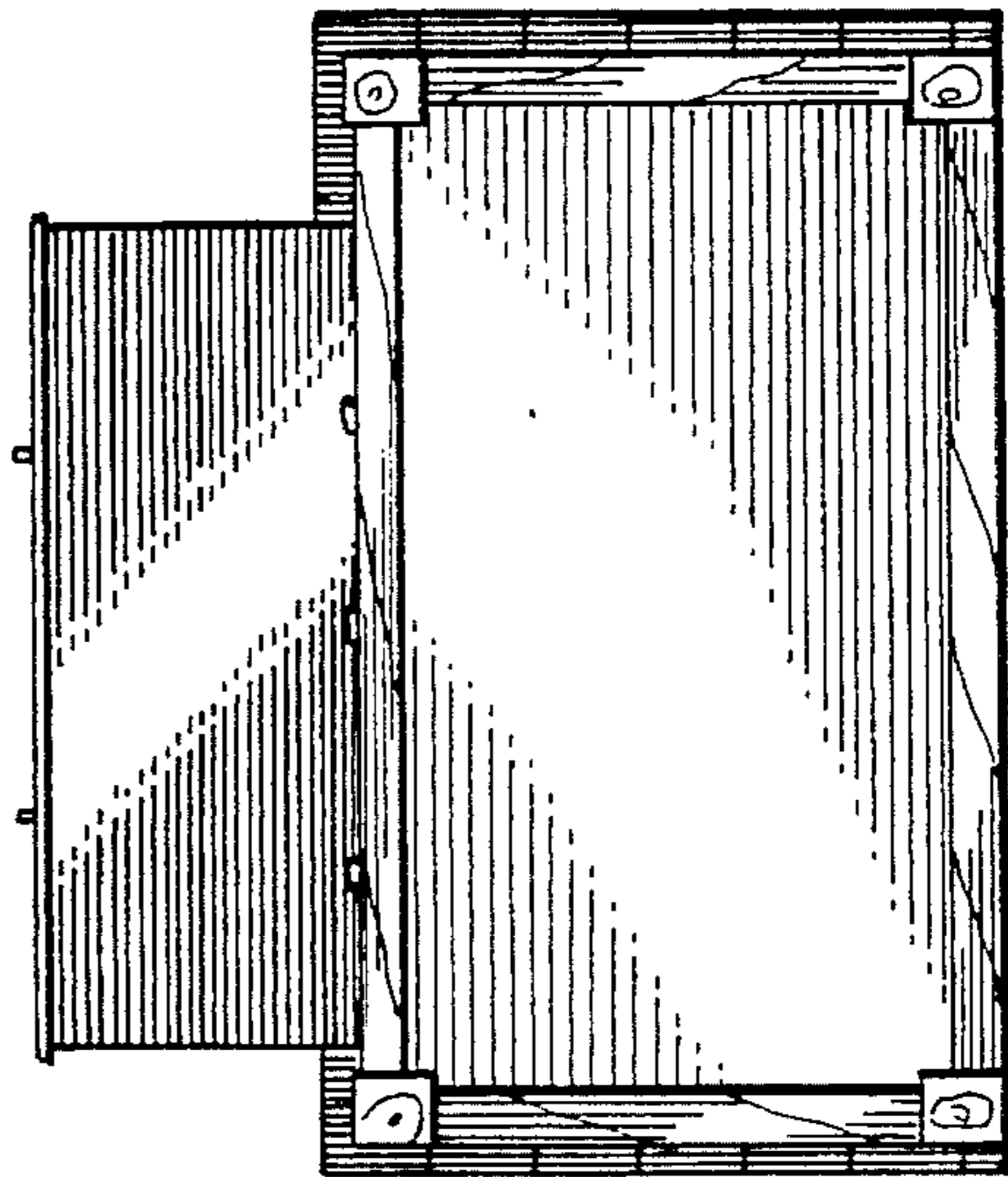

FIG. 10

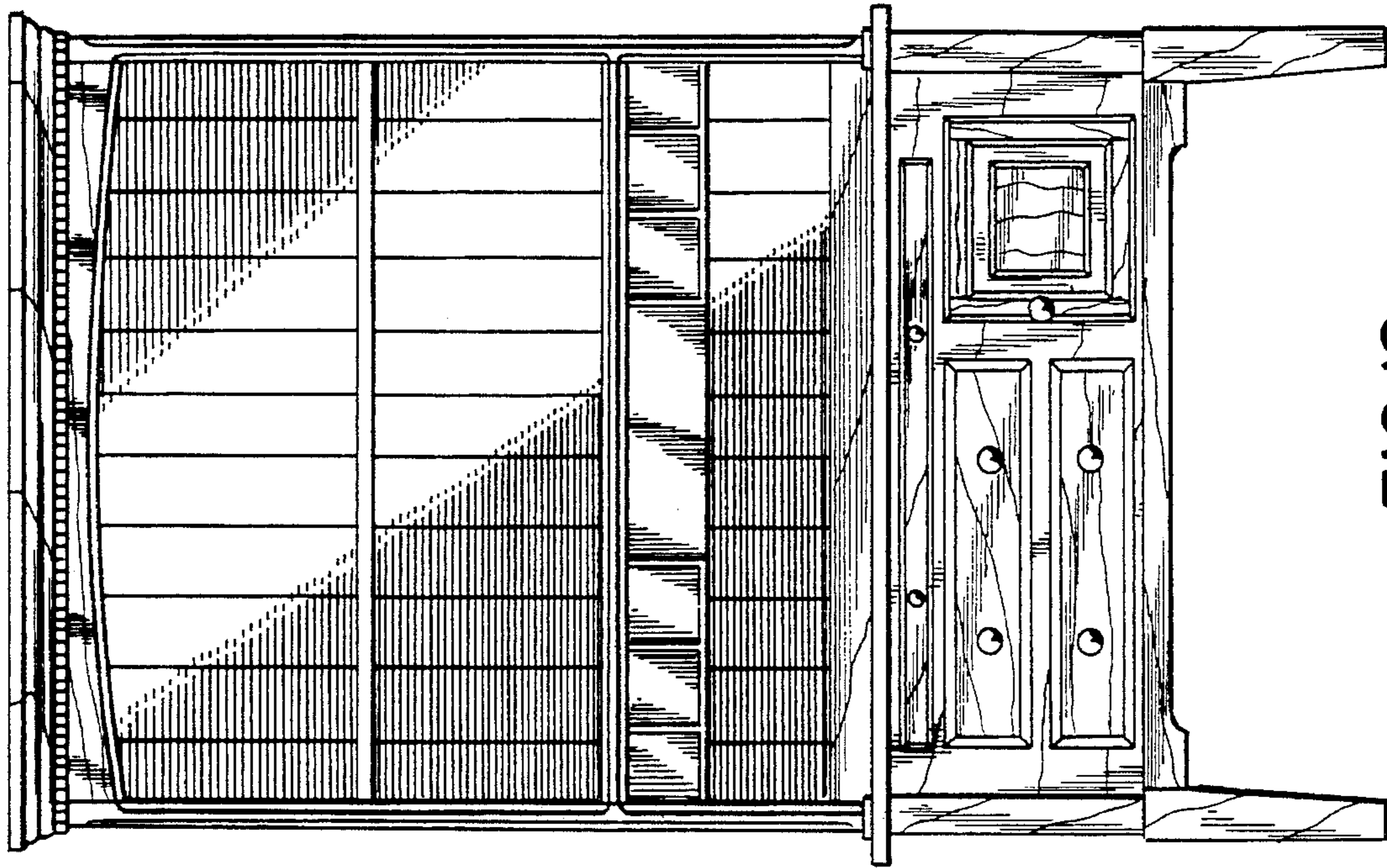

FIG. 12

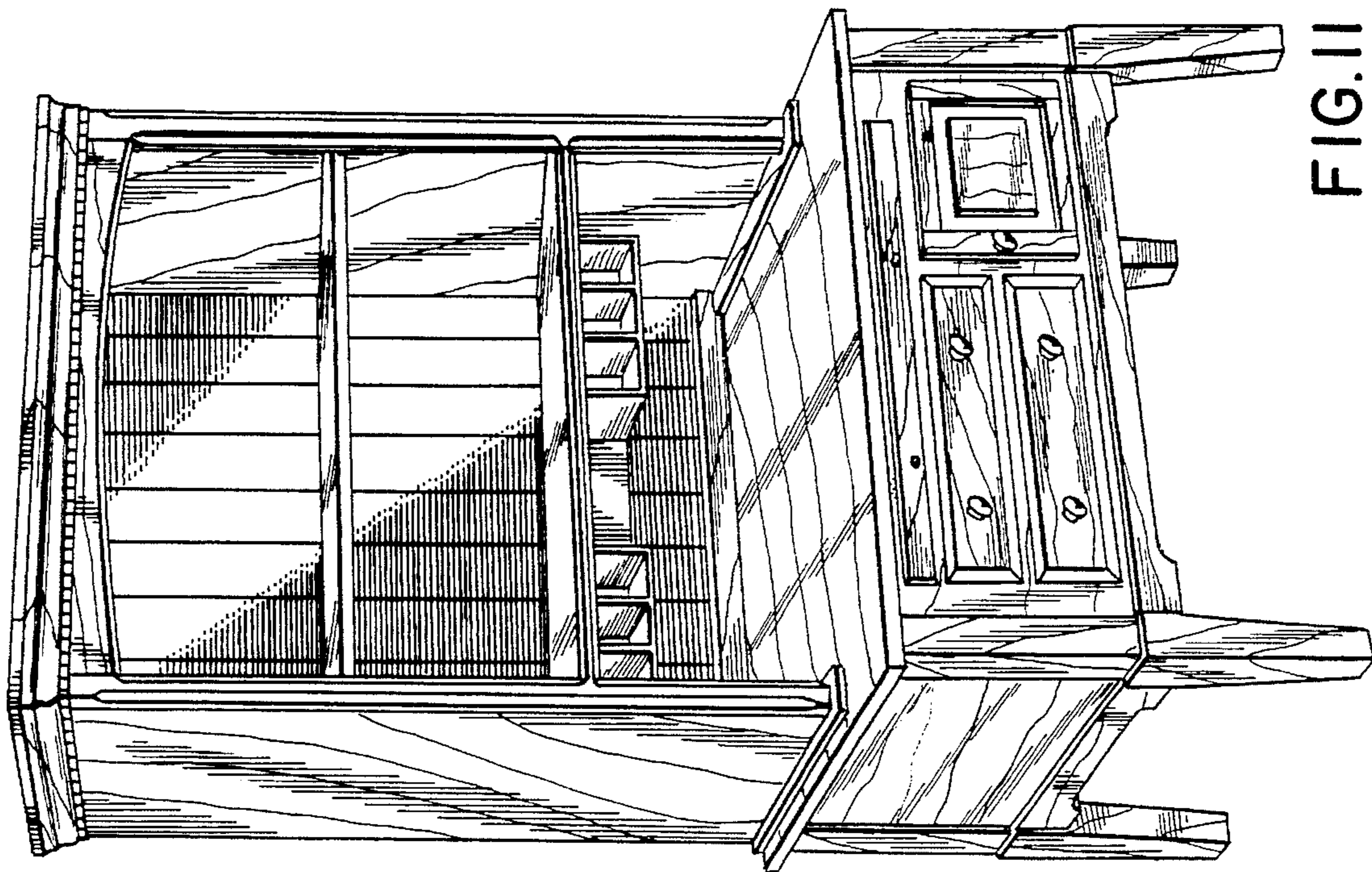

FIG. 11

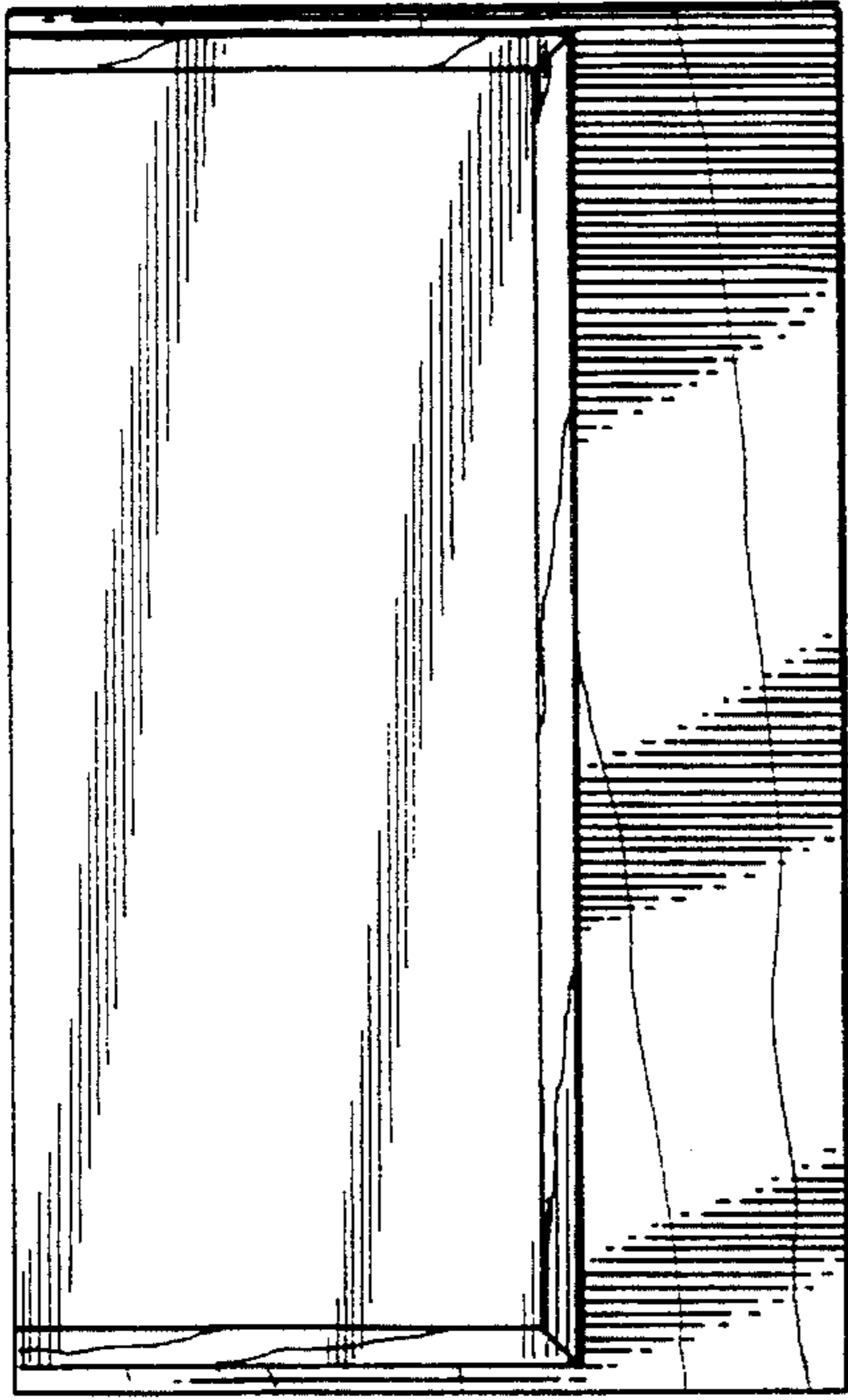

FIG. 14

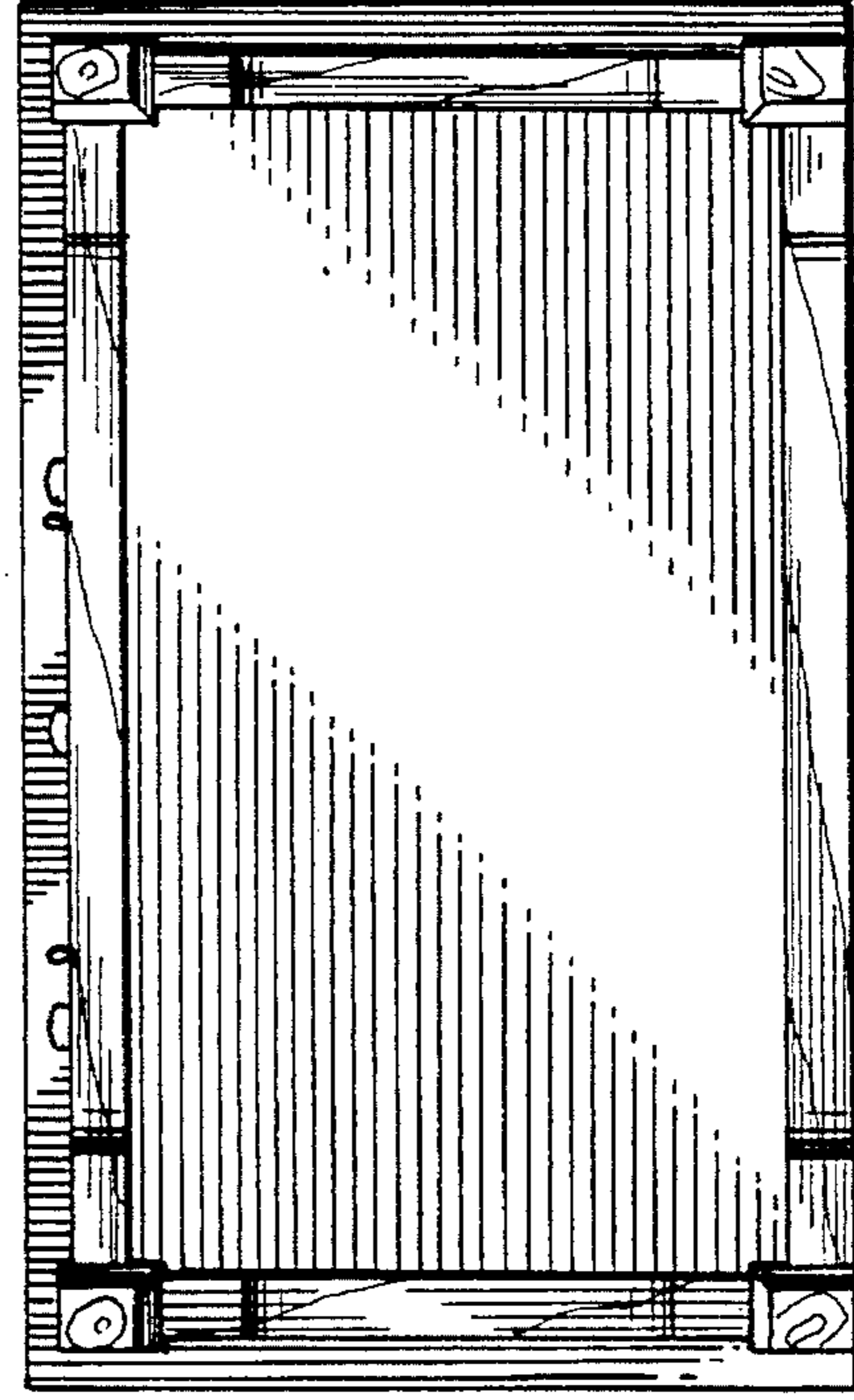

FIG. 15

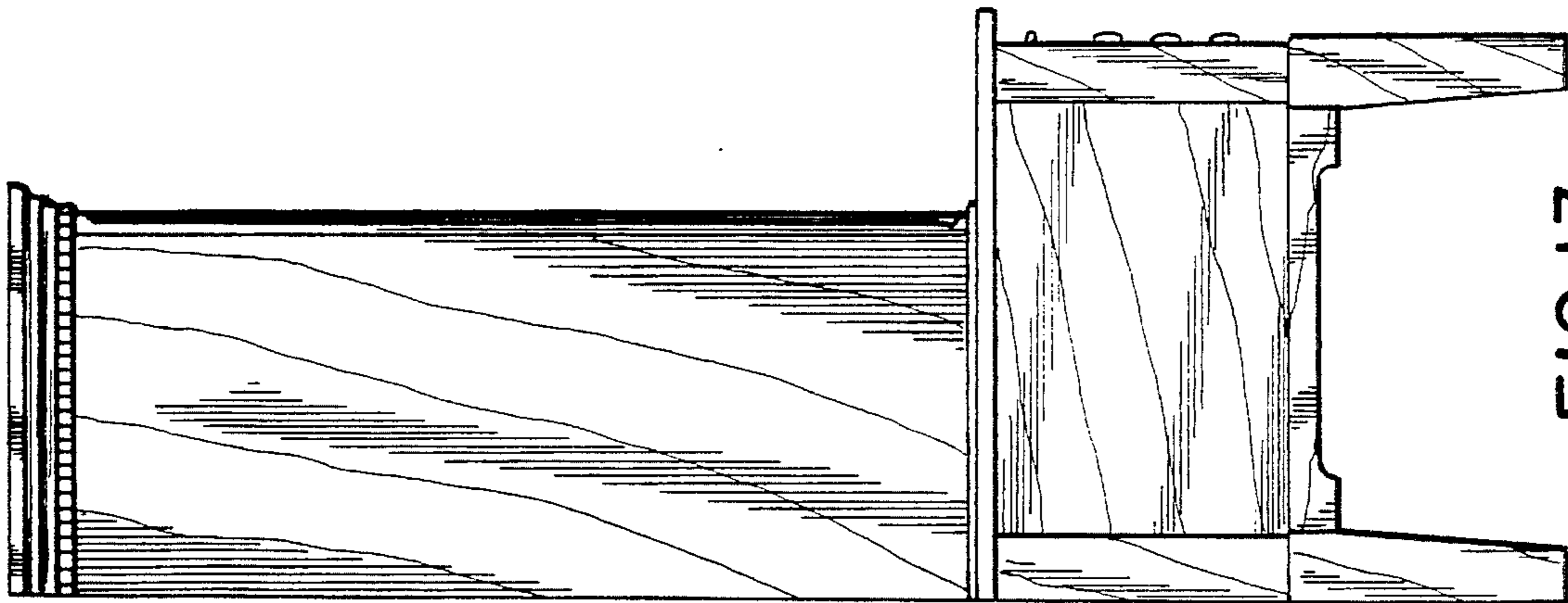

FIG. 13

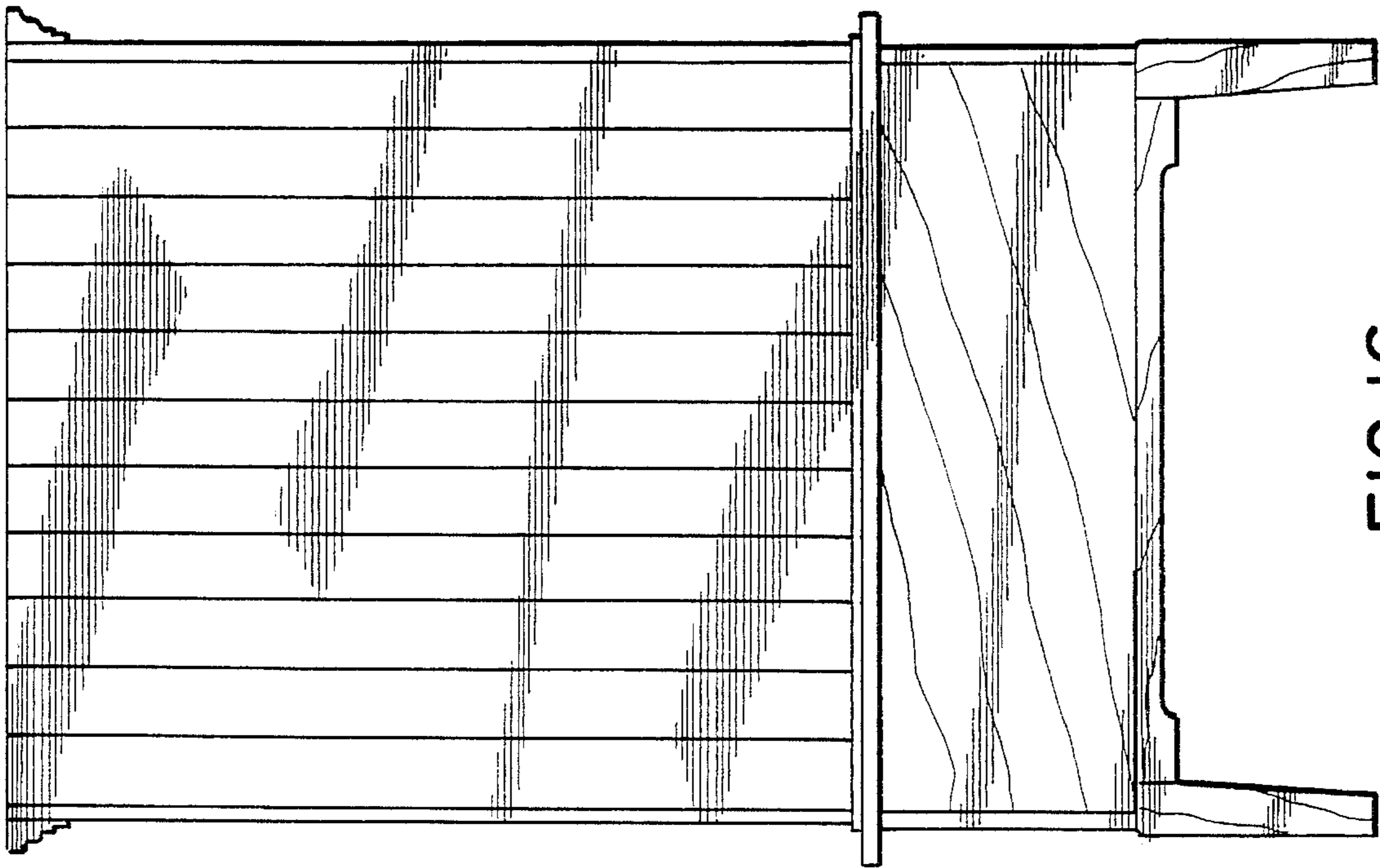

FIG. 16

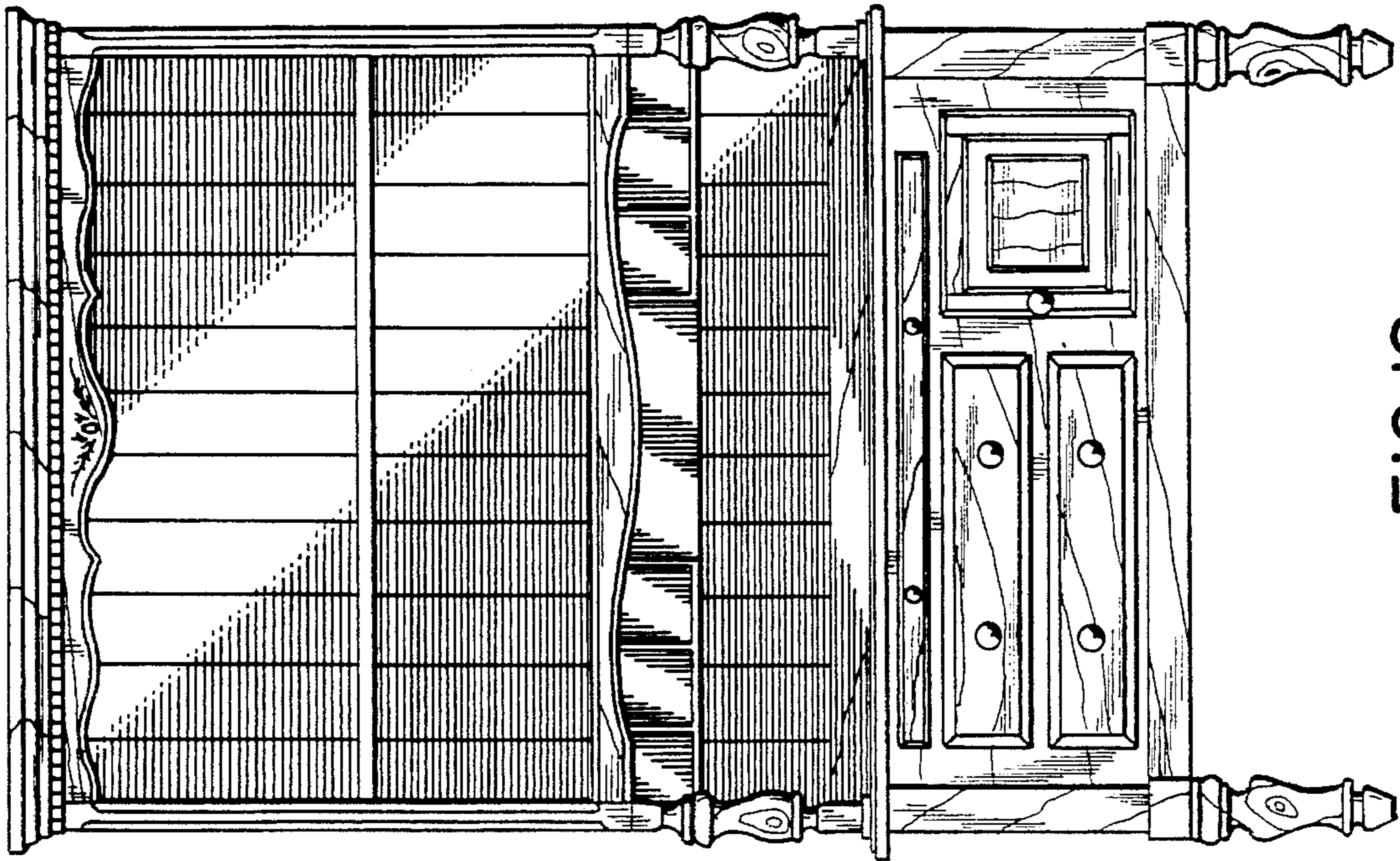

FIG. 18

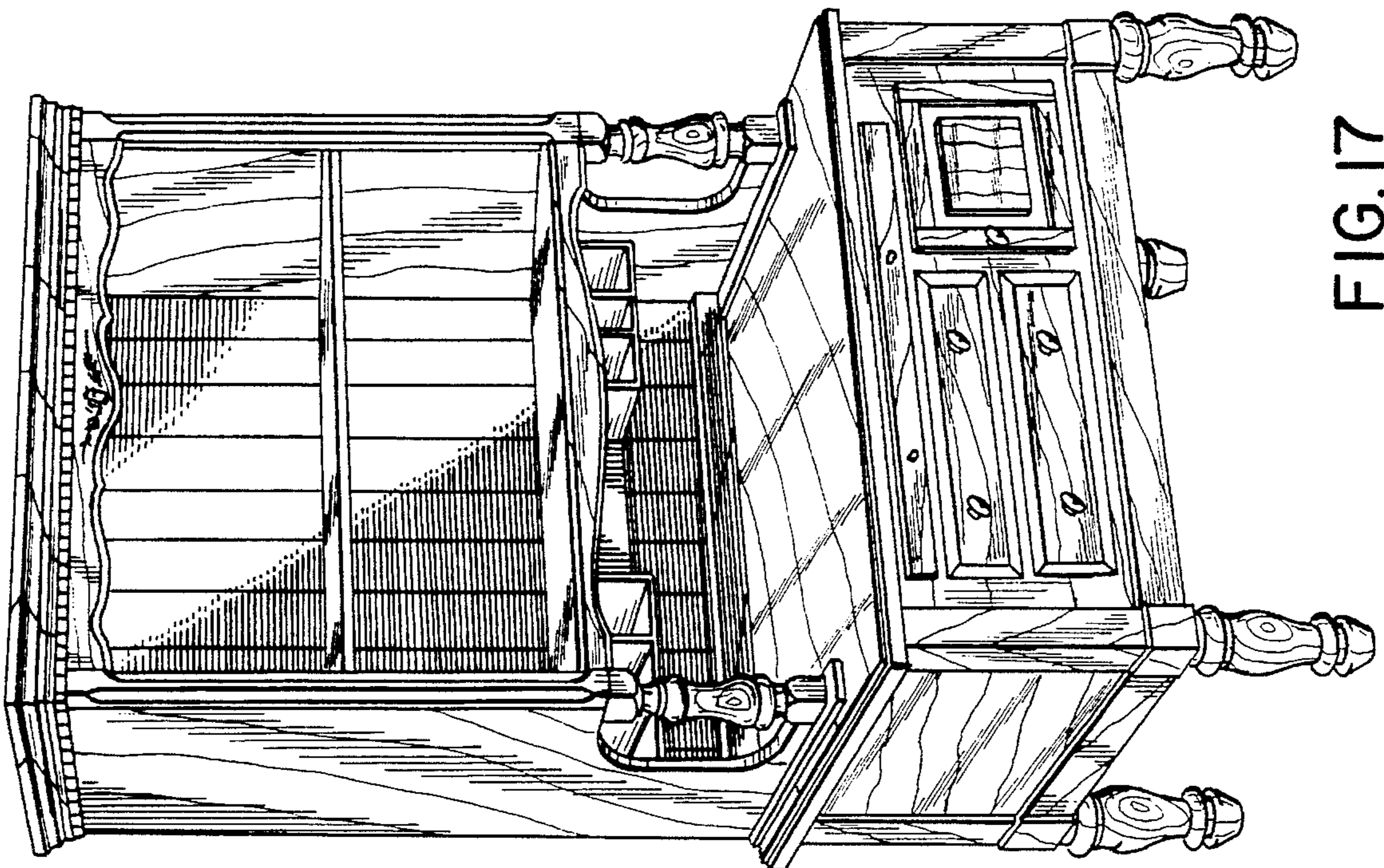

FIG. 17

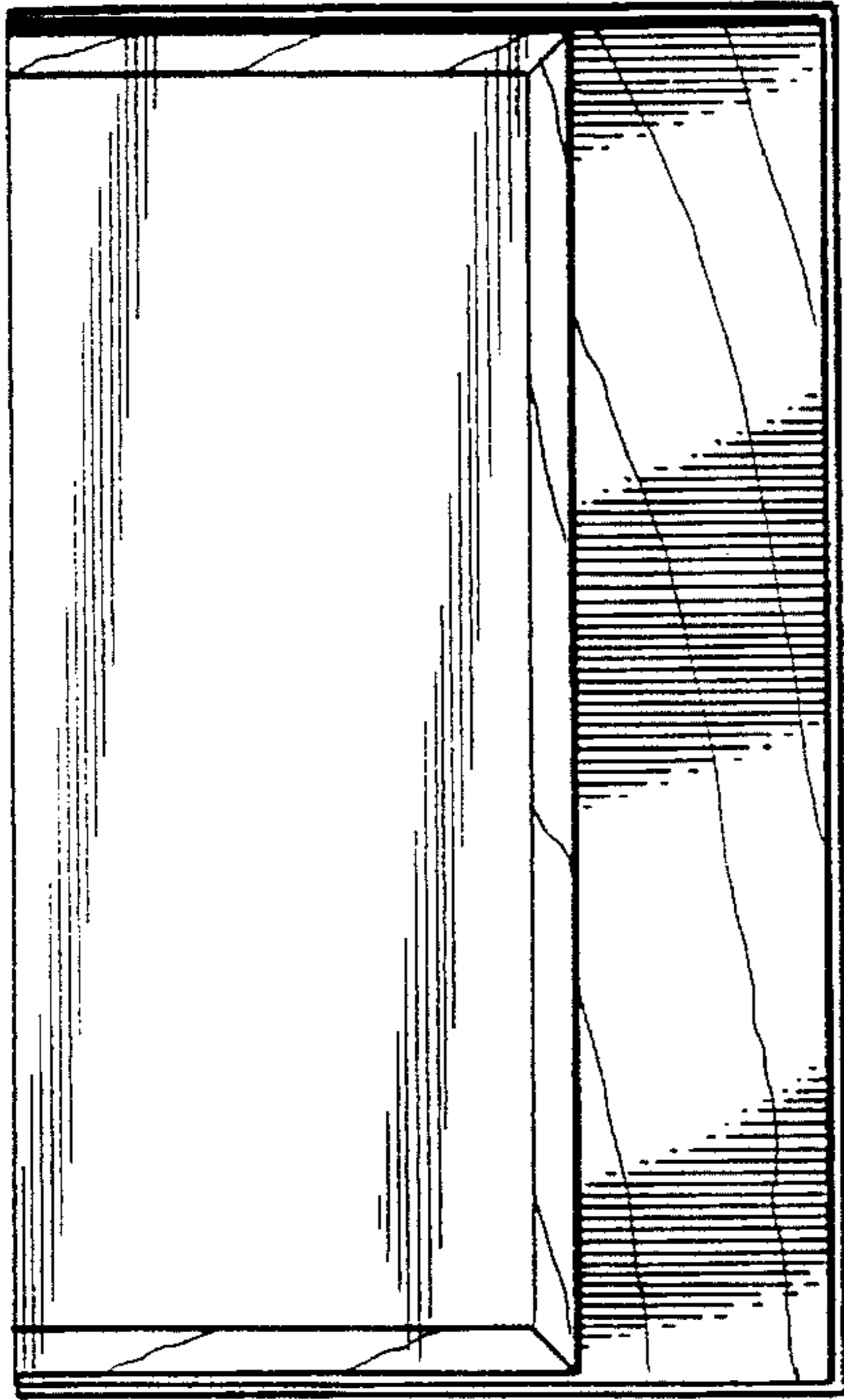

FIG. 20

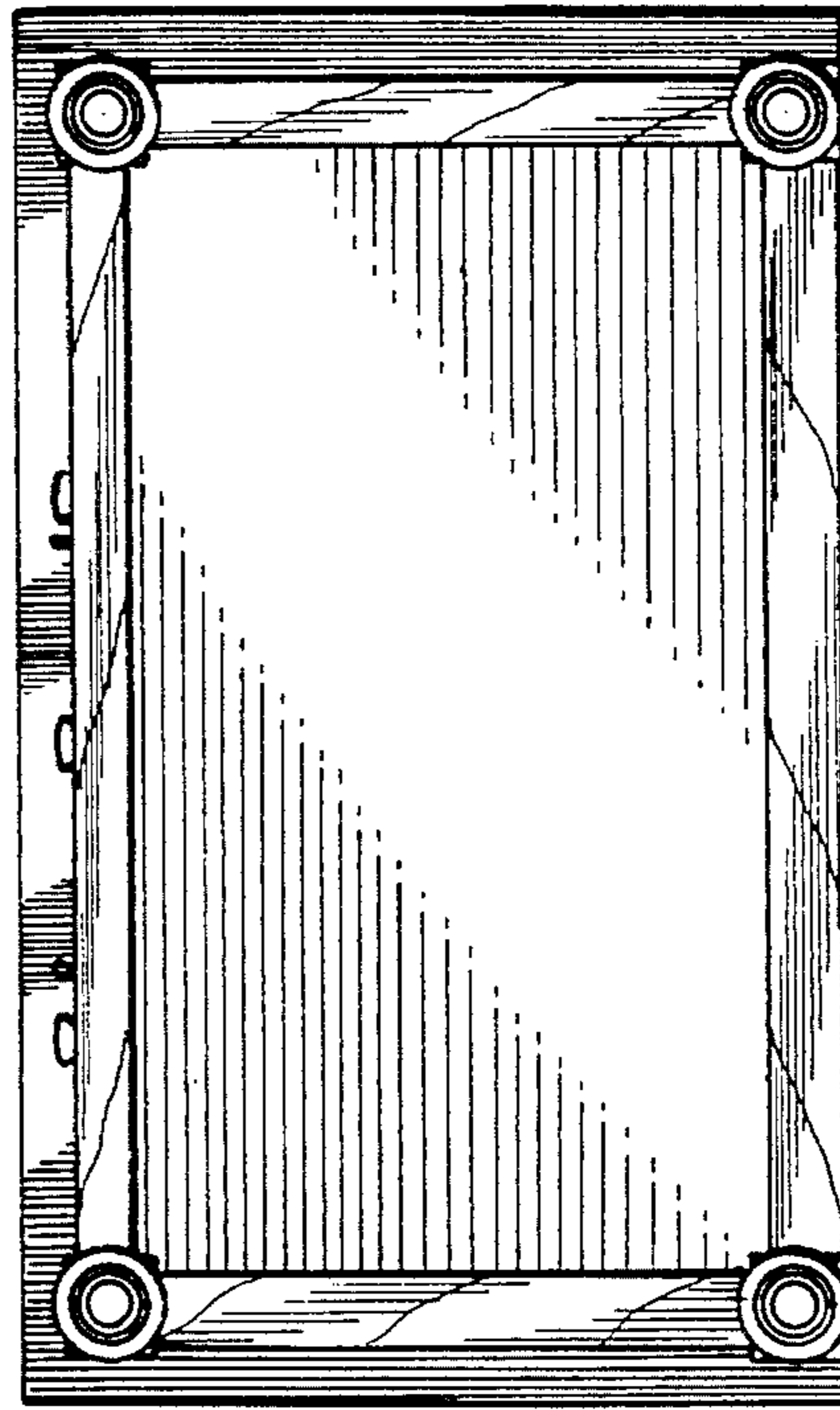

FIG. 21

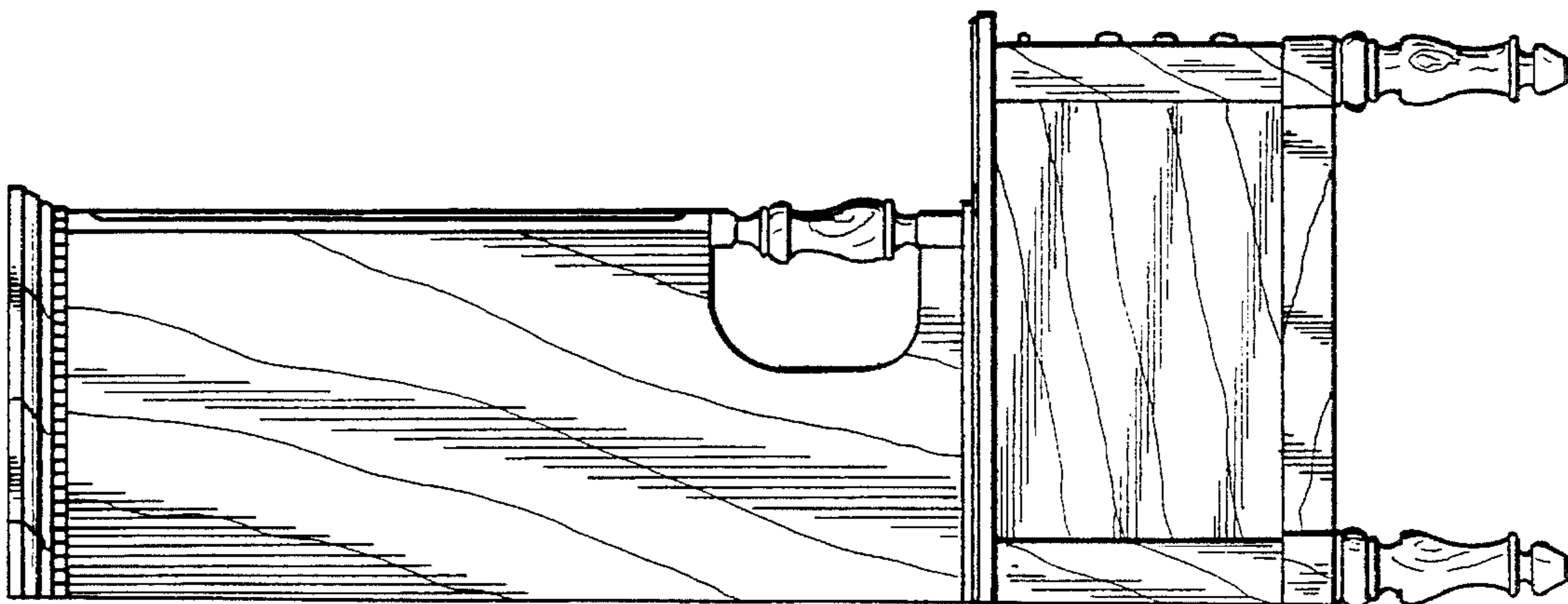

FIG. 19

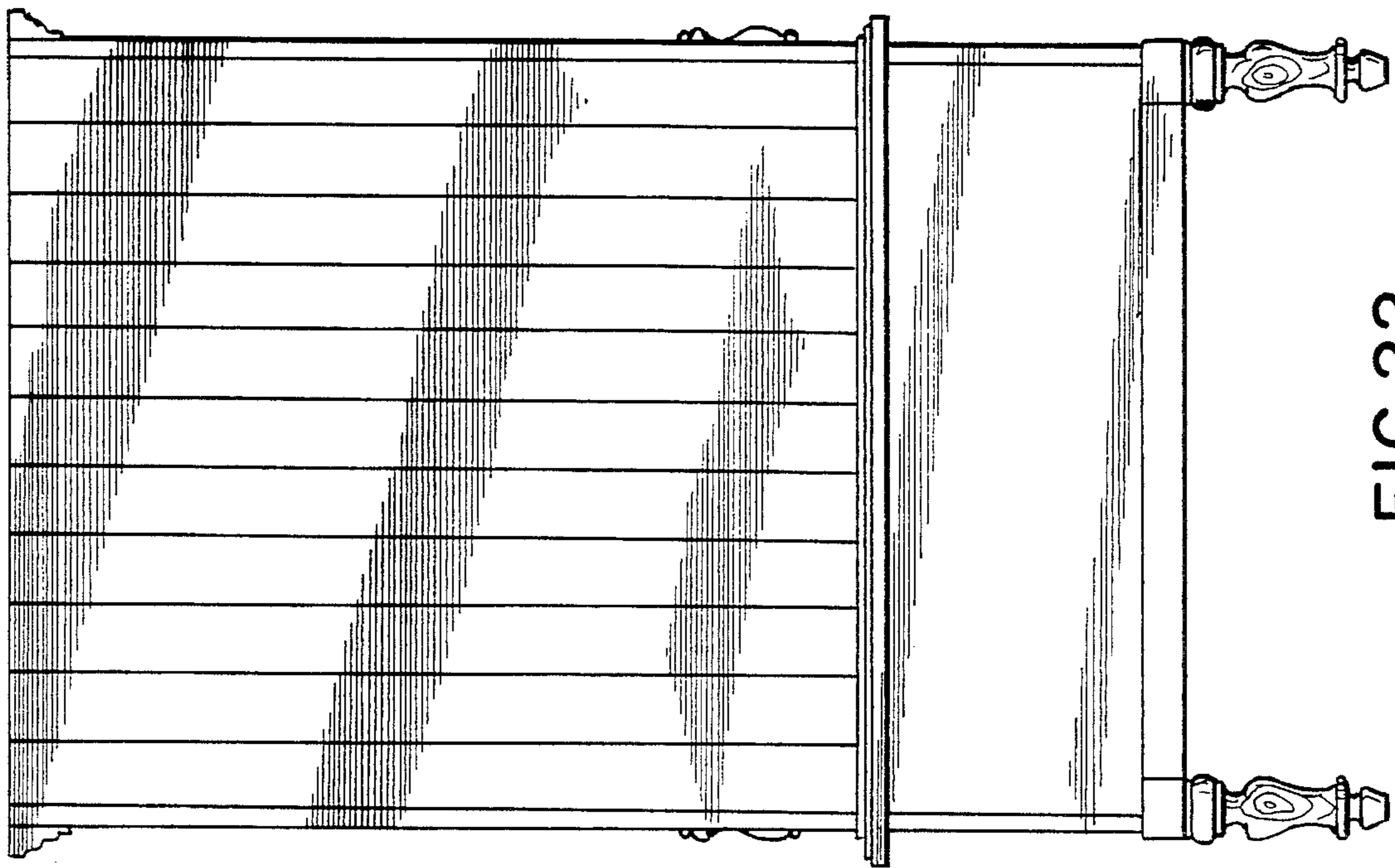

FIG.22