



US00D363725S

**United States Patent** [19]  
**Campbell**

[11] **Patent Number: Des. 363,725**

[45] **Date of Patent: \*\*Oct. 31, 1995**

[54] **PIPE COMPACTOR TOOL**

4,682,539 7/1987 Bramblett et al. .... D15/123 X

[76] Inventor: **Clinton B. Campbell**, 2702 50th Ave.  
NE., Tacoma, Wash. 98422

*Primary Examiner*—Antoine Duval Davis

[\*\*] Term: **14 Years**

[57] **CLAIM**

The ornamental design for a pipe compactor tool, as shown and described.

[21] Appl. No.: **19,272**

[22] Filed: **Feb. 28, 1994**

**DESCRIPTION**

[52] U.S. Cl. .... **D15/123; D15/199**

FIG. 1 is a front elevational exploded view of the pipe compactor tool showing my new design;

[58] **Field of Search** .... D15/123, 199;

404/133.2, 133.1, 133.05; D8/14, 16, 105;

405/271, 129, 131; 100/902

FIG. 2 is a rear elevational exploded view thereof;

FIG. 3 is a left side elevational exploded view thereof;

FIG. 4 is a right side elevational exploded view thereof;

FIG. 5 is a top plan view thereof;

FIG. 6 is a bottom plan view thereof; and,

FIG. 7 is an isometric exploded view thereof.

[56] **References Cited**

**U.S. PATENT DOCUMENTS**

D. 256,770 9/1980 Broyles ..... D15/123 X

2,870,696 1/1959 Yoch ..... 404/133.1

2,994,262 8/1961 Bator ..... 404/133.1 X

**1 Claim, 4 Drawing Sheets**

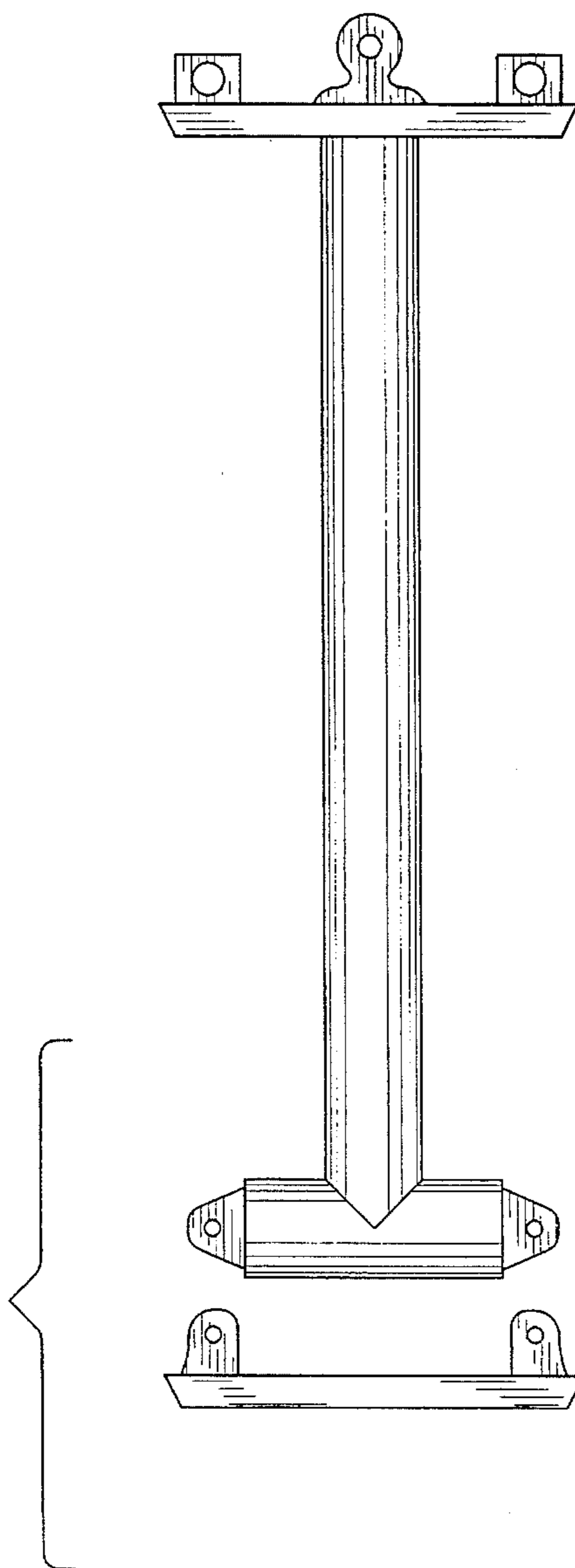

FIG. 1

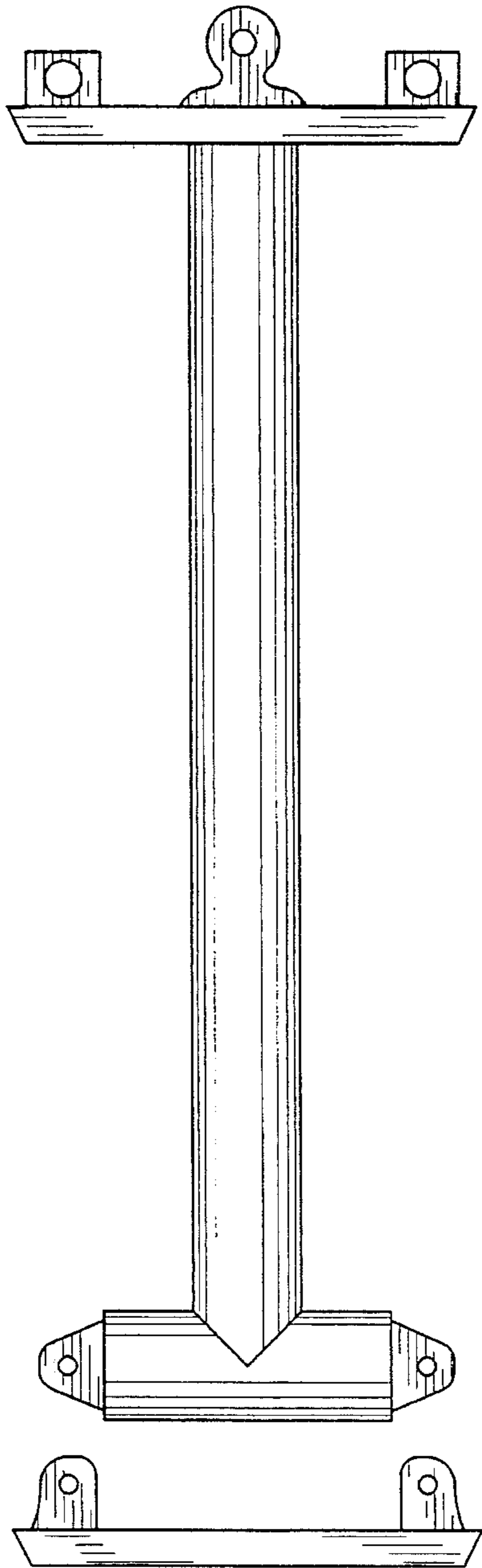

FIG. 2

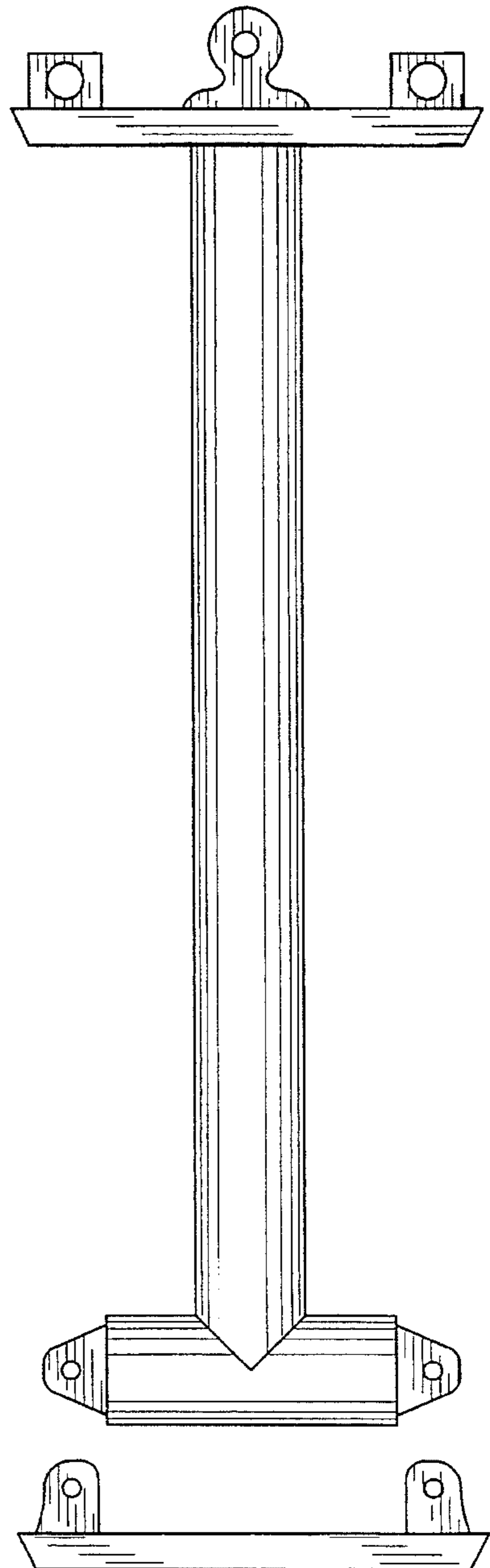

FIG. 3

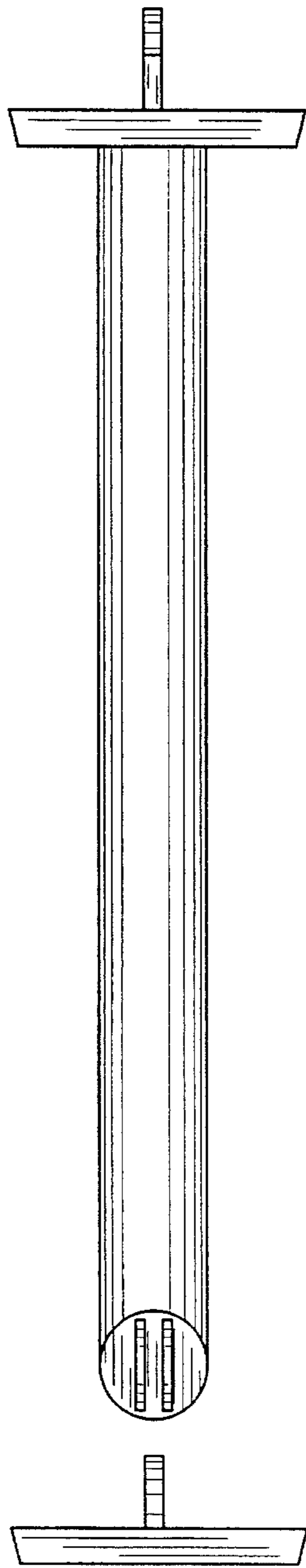
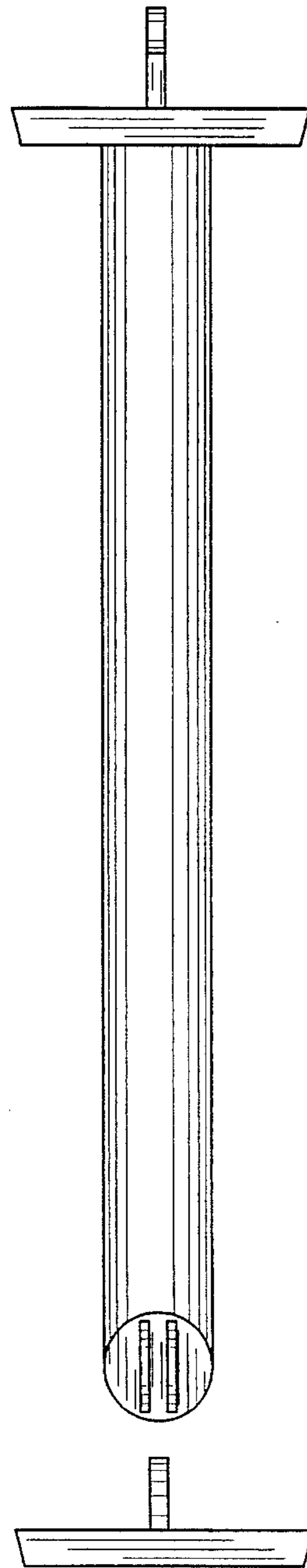
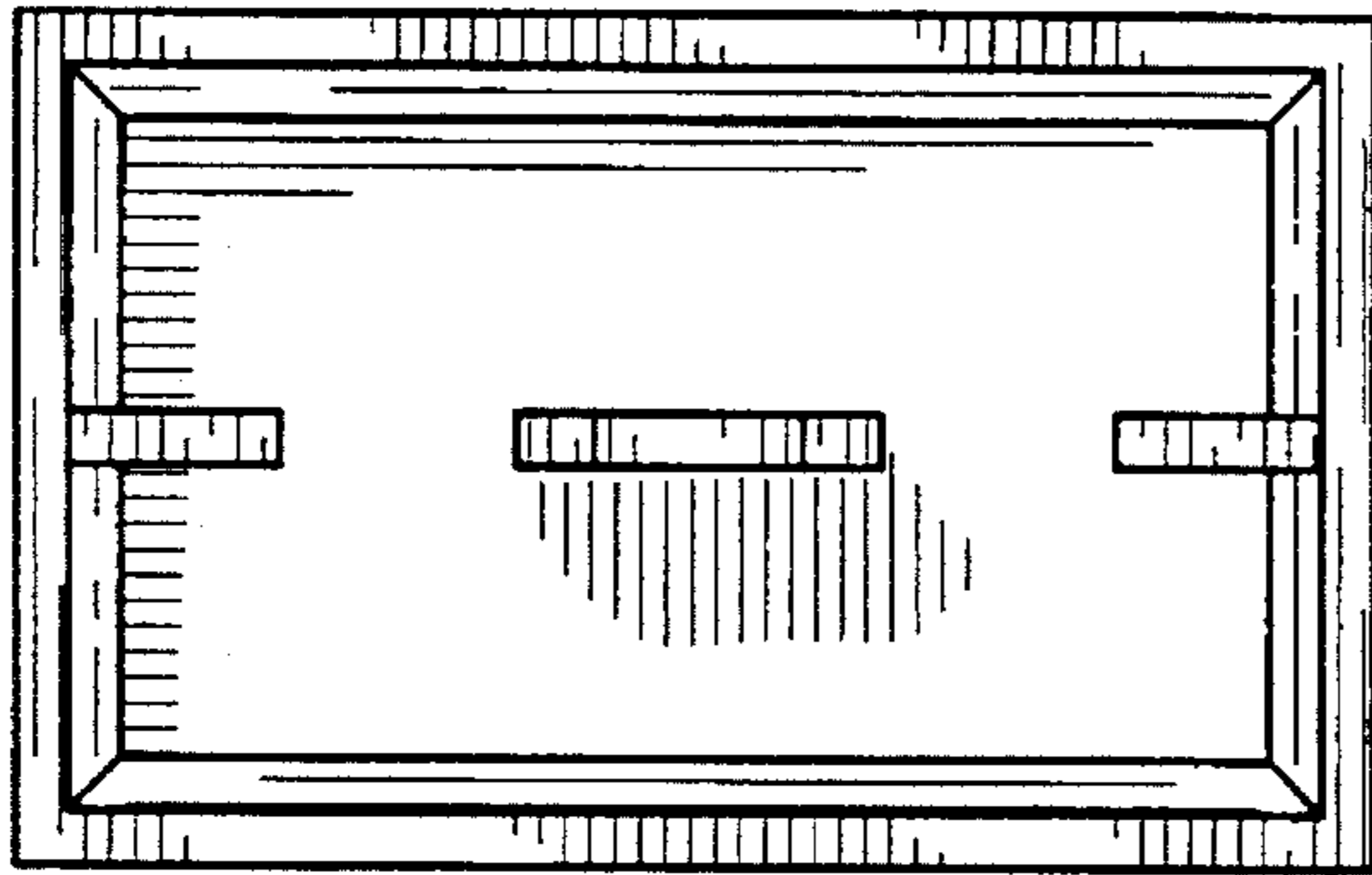

FIG. 4



*FIG. 5*



*FIG. 6*

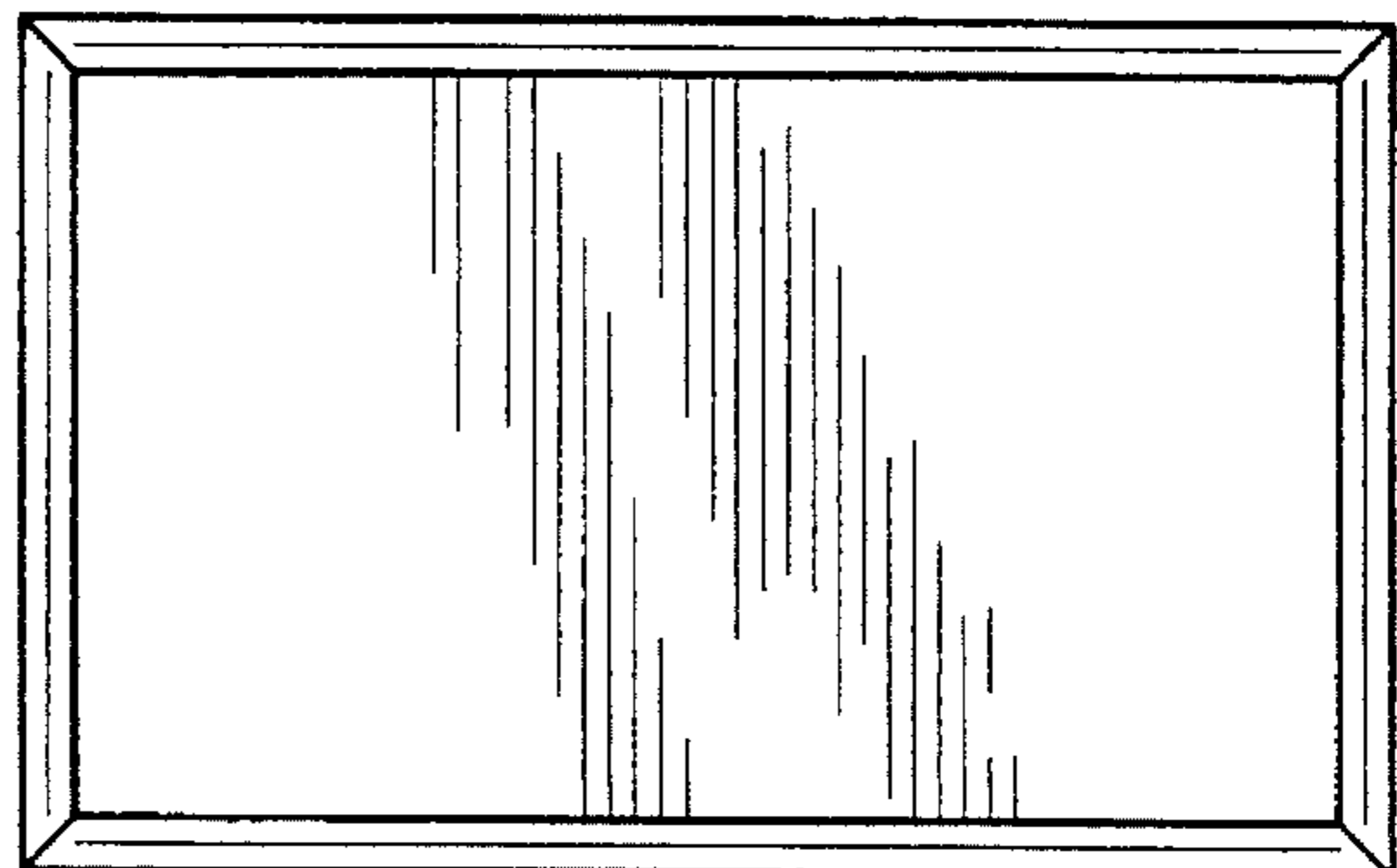

FIG. 7

