



US00D363688S

# United States Patent [19]

[11] Patent Number: **Des. 363,688**

**Turrentine**

[45] Date of Patent: **\*\*Oct. 31, 1995**

## [54] FOUR-LAYER PLANTER BOX

## FOREIGN PATENT DOCUMENTS

[76] Inventor: **John P. Turrentine**, P.O. Box 504, 114 Main St., Nantucket, Mass. 02554

2824506 12/1979 Germany ..... 47/83  
957455 5/1964 United Kingdom ..... D11/143

[\*\*] Term: **14 Years**

*Primary Examiner*—Alan P. Douglas  
*Assistant Examiner*—Cathron B. Matta  
*Attorney, Agent, or Firm*—Wiggin & Dana

[21] Appl. No.: **32,299**

## [57] CLAIM

[22] Filed: **Dec. 15, 1994**

[52] U.S. Cl. .... **D11/143**

The ornamental design for a four-layer planter box, as shown.

[58] Field of Search ..... D11/143; D19/85; 47/83

## DESCRIPTION

## [56] References Cited

### U.S. PATENT DOCUMENTS

D. 127,800	6/1941	Hayt	47/41.01 X
D. 140,082	1/1945	Hathaway	D11/143 X
D. 205,595	8/1966	Titus	D11/152
D. 269,074	5/1983	Spak	D11/143
D. 323,353	1/1992	Wagner	D19/85 X
440,141	11/1890	Dearborn	47/83 X
2,837,866	6/1958	Esmay et al.	47/83 X
3,374,574	3/1968	Haile	47/83
4,991,712	2/1991	Wagner	206/214

FIG. 1 is a front perspective view of a third layer planter showing my new design;  
FIG. 2 is a top view thereof;  
FIG. 3 is a side view thereof;  
FIG. 4 is a front view thereof;  
FIG. 5 is a back view thereof;  
FIG. 6 is a bottom view thereof; and,  
FIG. 7 is a vertical sectional view along lines 7—7 in FIG. 5.

**1 Claim, 3 Drawing Sheets**

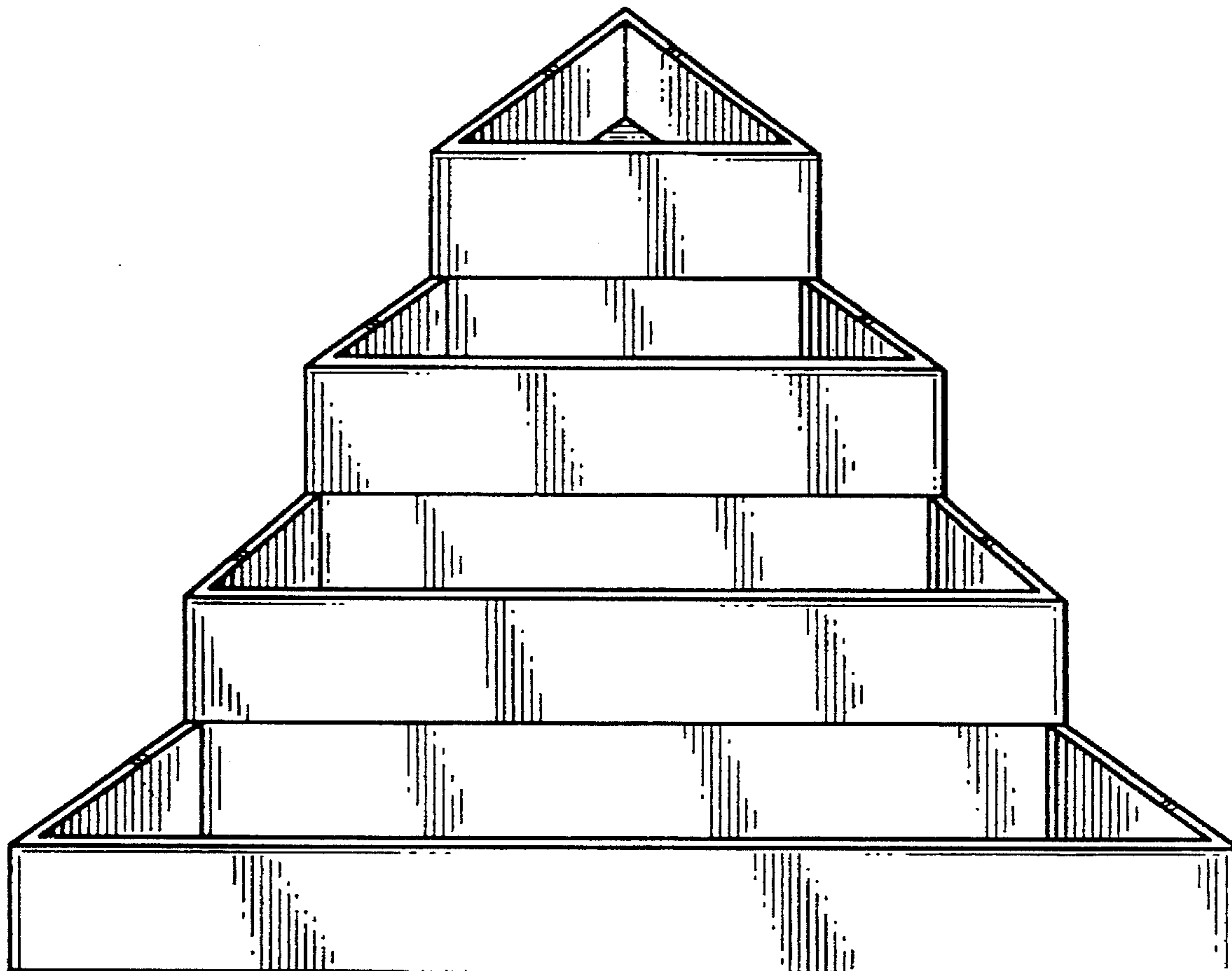

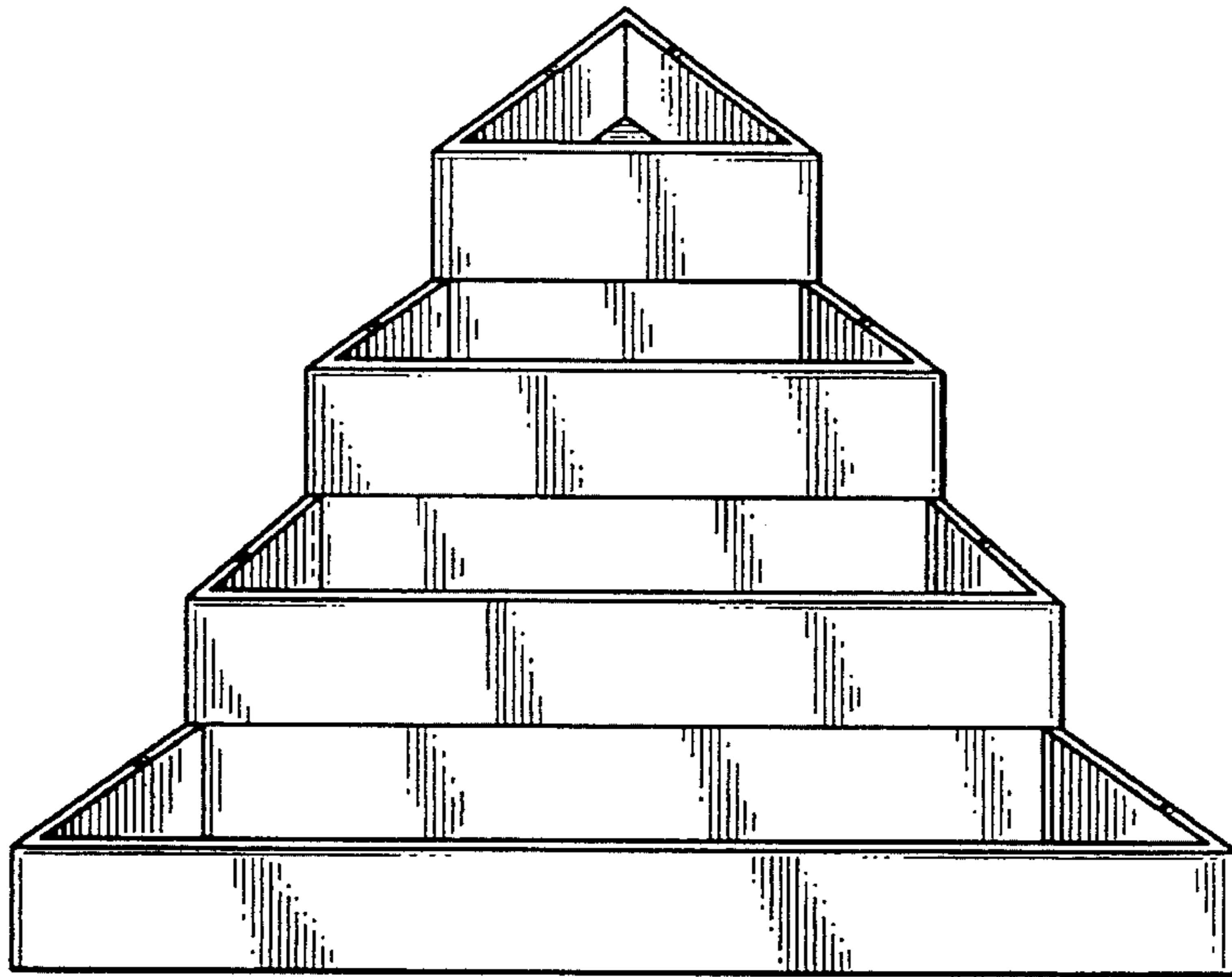

FIG-1

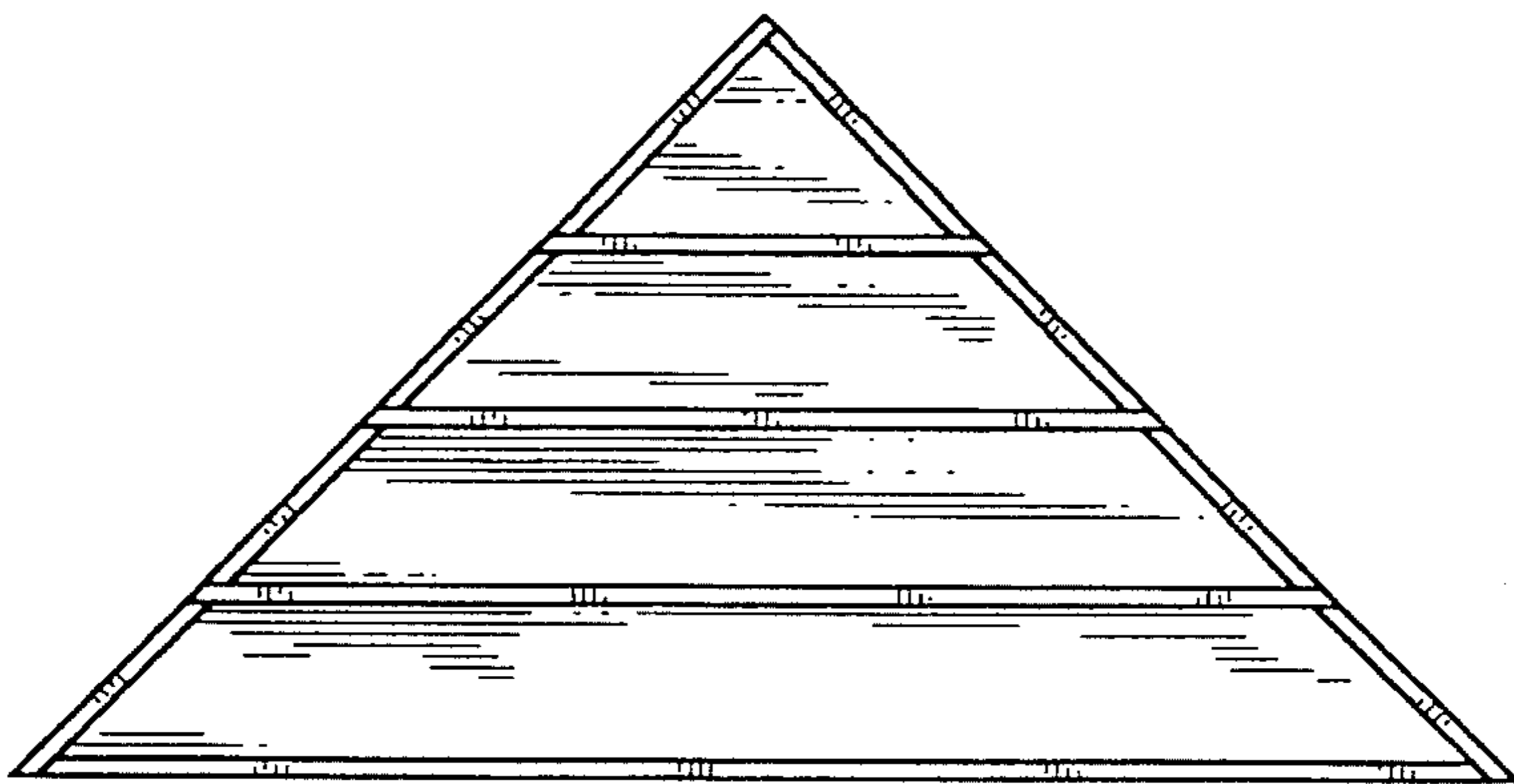

FIG-2

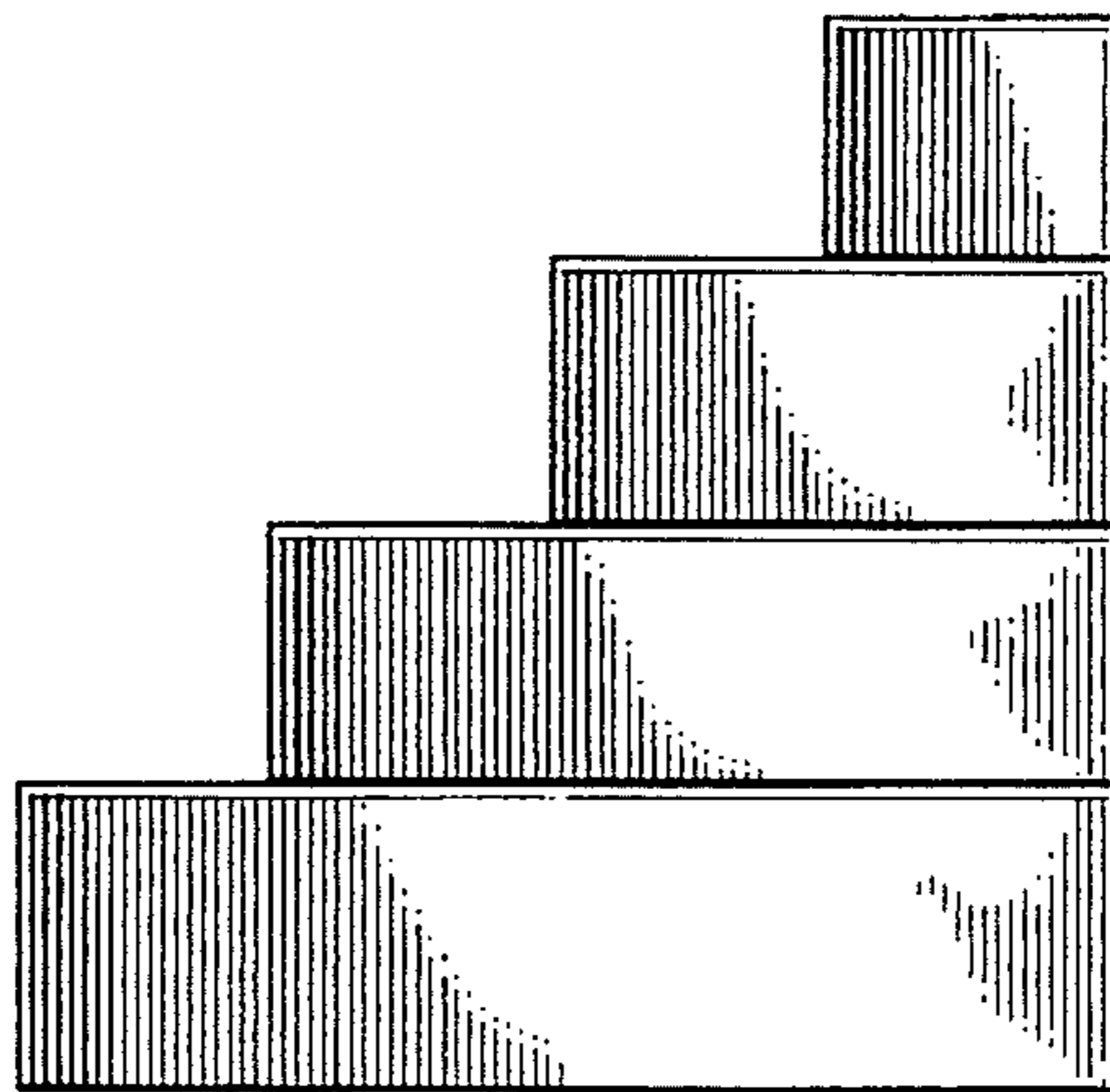

FIG-3

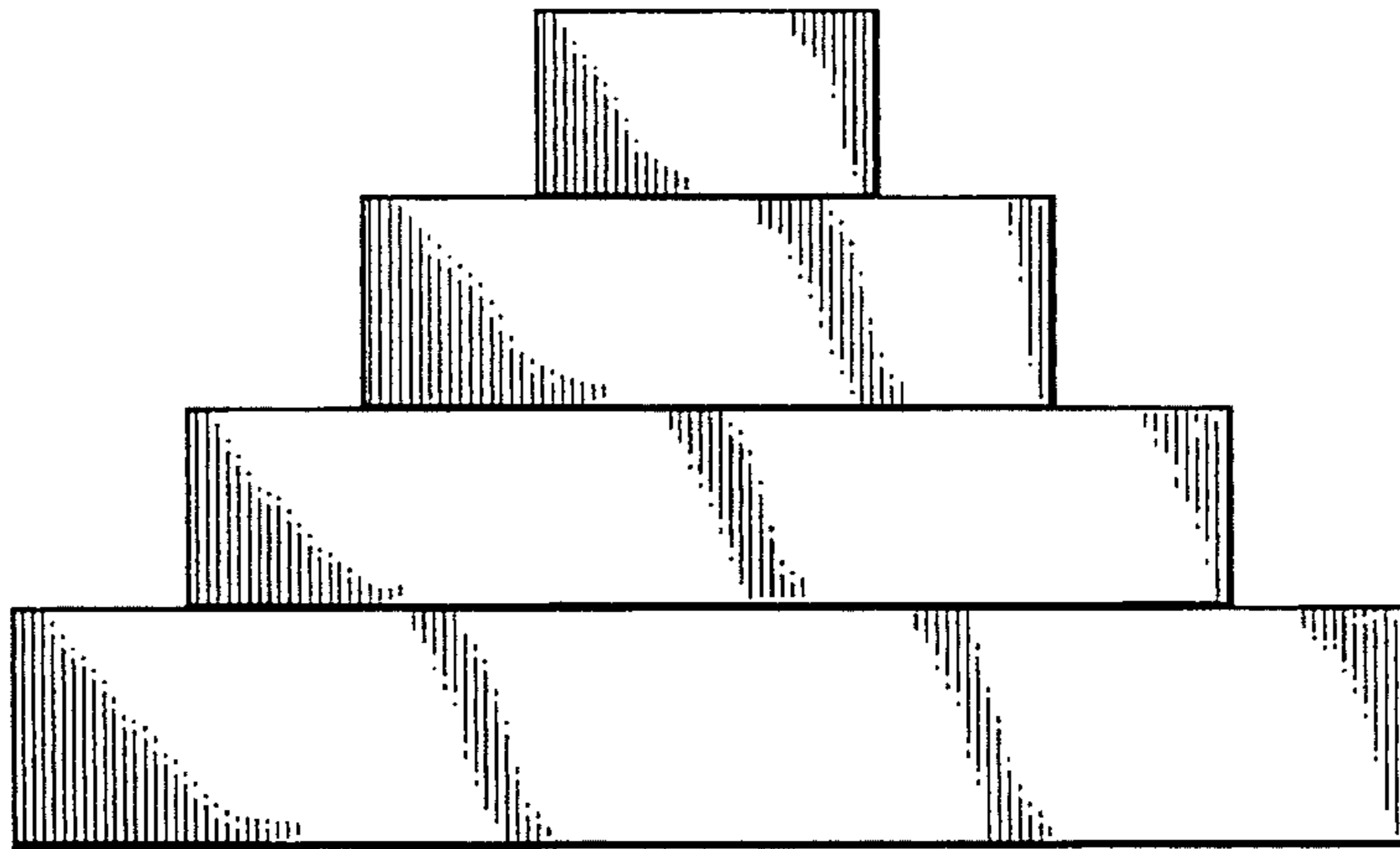

FIG-4

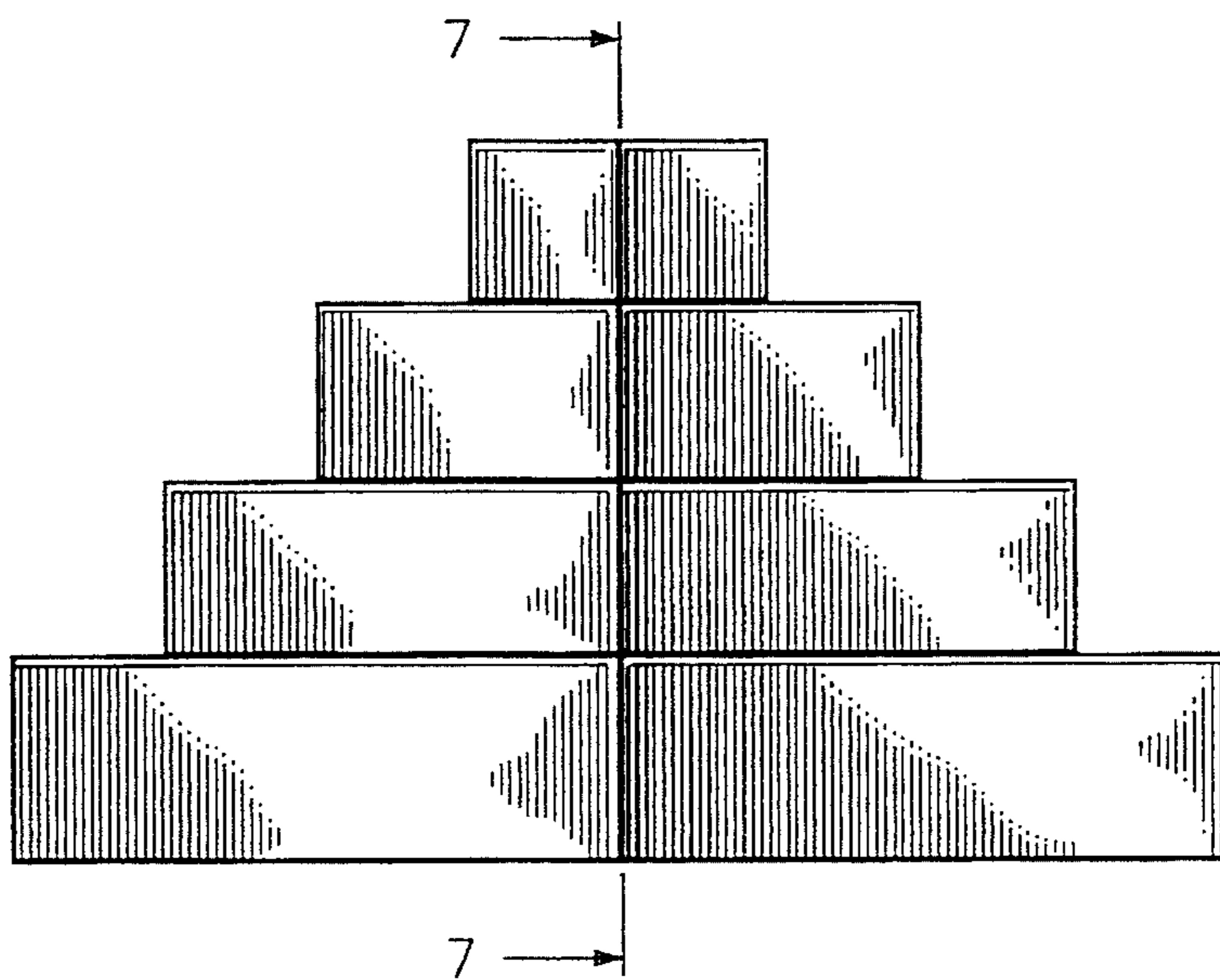

FIG-5

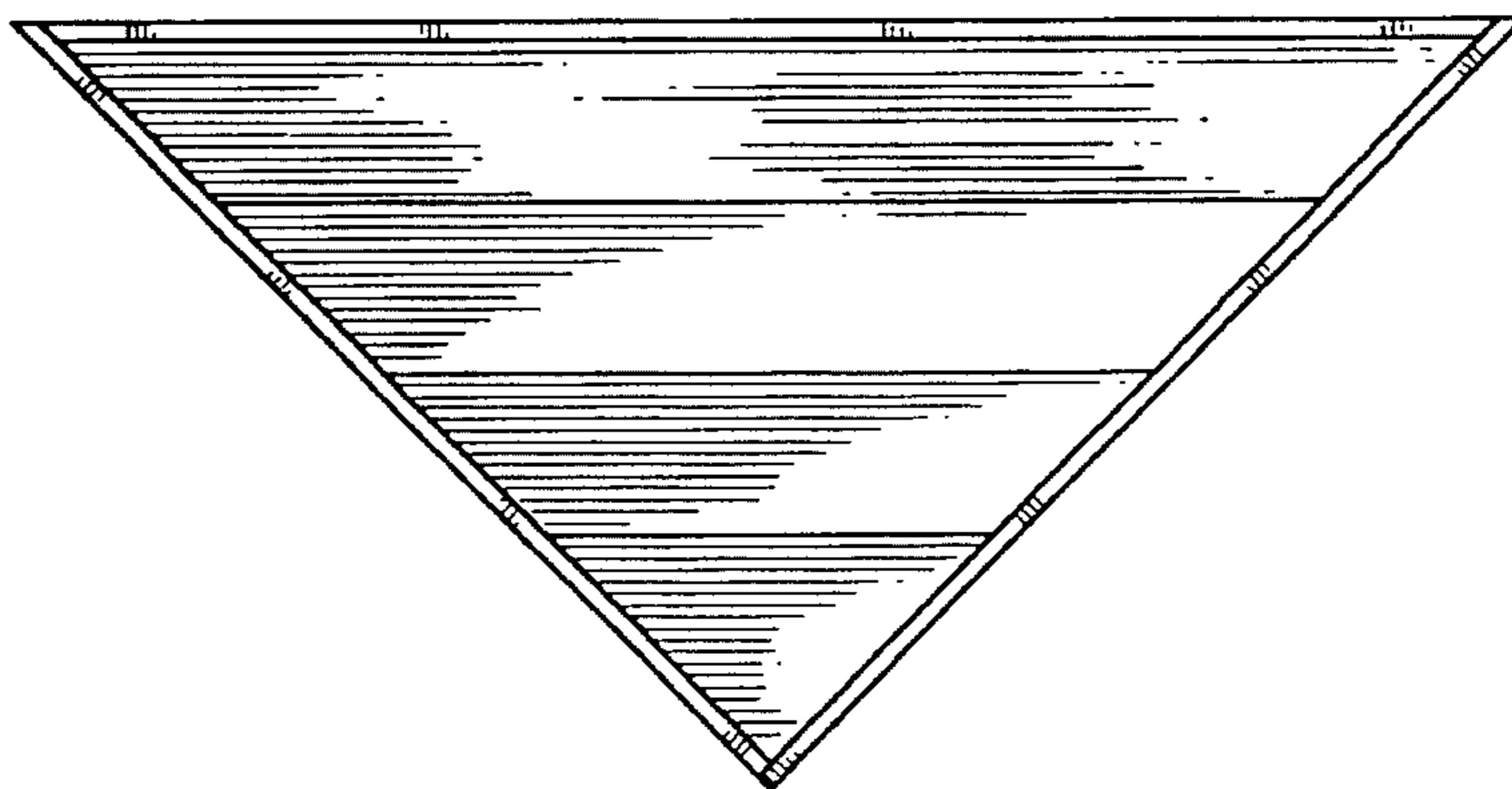
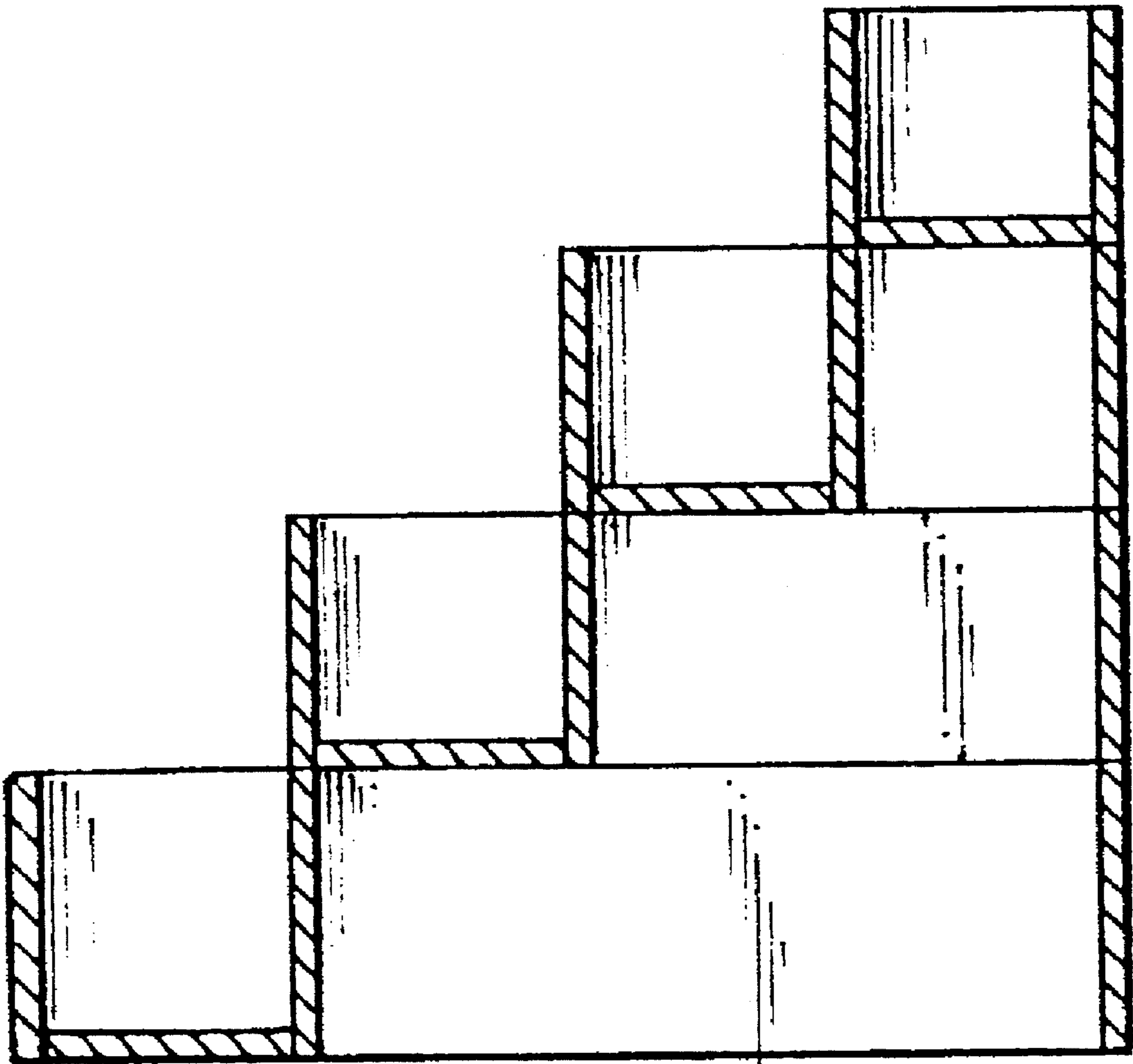

FIG-6



*FIG-7*